

ALPHABET

Curriculum



Notebook





Thanks for downloading!

Copyright 2015 Valerie McClintick

www.PreschoolMom.com

Permission to print for single family use only.

Purchase a Co-Op or Classroom license [Here](#)

No mass distribution, please read our [Full Terms of Use](#).

Images Full Copyright

[Little Red's Clipart](#)

[Pink Cat Studio](#)

[Zip a Dee Doo Dah Designs](#)

[Ink N Little Things](#)

Fonts licensed through [Kimberly Geswein Fonts](#) & Fonts 4 Teachers

Cover Image Full Copyright PreschoolMom.com 123rf/[scanrail](#) & Mighty Island

Visit our [eStore](#) for more Preschool & Kindergarten Activity Books





Getting Started

Gathering Supplies: As you'll be using this alphabet binder heavily over the coming months I suggest you purchase a **durable brand** and confirm that it can hold up to 650-700 pages. If you like you can purchase at least **26 page separators or binder tabs** and label them with the letters of the alphabet. You can purchase a custom pack of alphabet tabs as well.

Assembly: Because our Alphabet Curriculum prints out in a Letter of the Week format you simply need to print and then divide each letter into its corresponding section. With this you'll be set with 4 worksheets and/or activities a day over 4 days a week for the next 26 weeks. Just below you can read the suggested order of the worksheets and games, and if necessary rearrange them to suit your schedule.

Game Prep: For each letter there are three resources that need cutting (Flashcards, Bingo, Letter Puzzles). You can cut these out tableside or you can do so beforehand as part of your initial binder preparation. Taking things a step further, you could laminate these items for prolonged use with your children, but it is not a necessary step. Store items in a binder pocket or pencil pocket for easy access. Many games can be used as review or built upon as children learn subsequent letters.

Suggested Calendar

4 Days a Week

Monday	Tuesday	Wednesday	Thursday
How to Write Stroke Chart	Beginning Letter Chart	Blank Alphabet Worksheets x2	Letter Shape Puzzle
Beginning Letter Coloring Page	I Can Color Worksheet	I Can Find the Letter	ABC Quilt Worksheet
Handwriting Practice Page	Write and Read Worksheets x2	Trace Worksheet	Write and Read Blank Worksheet
Daily Math Worksheet	Race to the Top Worksheet	Count and Graph	Alphabet Memory Flashcards
			BINGO

3 Days a Week

Monday	Wednesday	Friday
How to Write Stroke Chart	Beginning Letter Chart	Blank Alphabet Worksheets x2
Beginning Letter Coloring Page	I Can Color Worksheet	I Can Find the Letter
Handwriting Practice Page	Write and Read Worksheet	Trace Worksheet
Daily Math Worksheet	Race to the Top Worksheet	Count and Graph
Letter Shape Puzzle	ABC Quilt Worksheet	Write and Read Blank Worksheet
Write and Read Worksheet	Alphabet Memory Flashcards	***BINGO***

Letter of the Week Curriculum Pages

Monday:

How to Write Chart: Use the chart to introduce children to the proper formation of both the uppercase and lowercase version of the letter. Key words are written below to gently guide your child with their finger to practice.

Beginning Letter Coloring: This is a simple coloring page featuring the upper and lowercase letter a beginning letter picture and word to color.

Handwriting Practice Page: This page reminds children of the proper letter formation and strokes. Beginning letter words are shown to provide ample practice opportunity.

Daily Math Worksheet: This is a simple worksheet but includes a variety of math skills over the course of the curriculum. Counting, Measuring, Addition, Tally Marks, Patterns, Ordinal Numbers, Positional Words, Number Line and more. The goal is to provide simple daily tasks children can build upon.

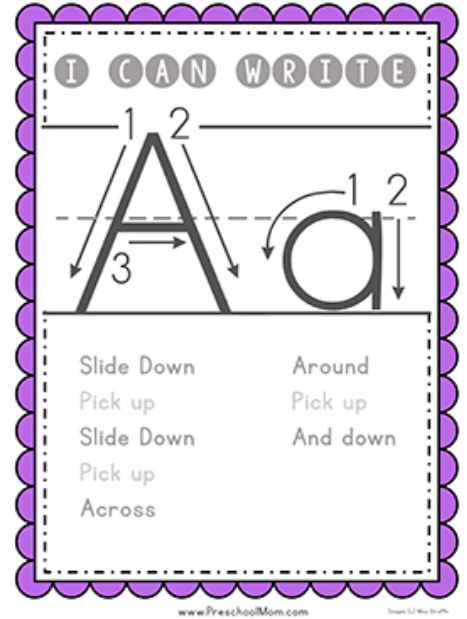

Tuesday:

Beginning Letter Chart: Shows children 10 different beginning letter words. Hang in the classroom, practice letter sounds, play tic-tac-toe, print two for a matching game....etc.

I Can Color Worksheet: This page features a variety of beginning letter pictures within the uppercase letter. Children follow the instructions for coloring.

Write & Read Worksheets: This worksheet includes three different versions: Uppercase, Lowercase and Blank. On Tuesday children will only complete the upper and lowercase versions. This is a simple tracing page for children to fill in the missing beginning letter. The font of the entire word is light so children can trace the entire word if they want to.

Race to the Top: This is a fun game played with a paperclip spinner. Children spin the paperclip and then trace the correct winner (uppercase or lowercase). The first letter to the crown wins! Follow up questions guide children through less and more and inequalities.



Wednesday:

Blank Letter Pages: These are very versatile and can be filled in with playdough, stamps, designs, stickers, things that start with that letter...etc. You might print multiple copies of these if you have crafty kiddos.

I Can Find the Letter: This is a worksheet for children to find and count the upper and lowercase letters.

Letter Trace: Children trace the uppercase and lowercase letters by using the guides provided. Opportunity is provided to make their own letters and color in a beginning letter picture for each row they complete.

Count & Graph Worksheets: Children count up the letter items and then graph them accordingly. The first half of the alphabet features up to 5 total items, and the second half reaches to 10 total items.

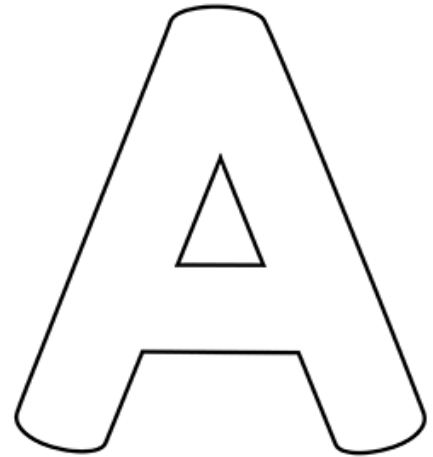

www.PreschoolMom.com

Thursday:

Letter Shape Puzzle: These puzzles can be cut out and laminated ahead of time if desired. To support children with different abilities, four different pages per letter are included. You can mix and match these to use one as a puzzle board and one for pieces.

ABC Quilt Square: This page features handwriting practice as well as coloring. Children cut out their own quilt square and place on the wall or within a quilt pocket chart, building their quilt with each letter completed.

Write & Read Worksheets: On Thursday children will complete the remaining Write and Read worksheet by writing the letter in on the blank page.

Alphabet Memory Flashcards: Flashcards can be used in a variety of ways. You can bind them together with an s-clip, use them with a table top pocket chart, or even play a game of concentration. A sorting page is included to make games of two or more sets. As you work through your curriculum the flashcards can be used for ABC order, letter sound differential and various card games like go fish!



www.PreschoolMom.com
Images © Little Red's Clipart & Tip n' Tack Art Designs

4 in a Row Bingo: Finish out your Letter of the Week by playing a fun game of BINGO!

I CAN WRITE

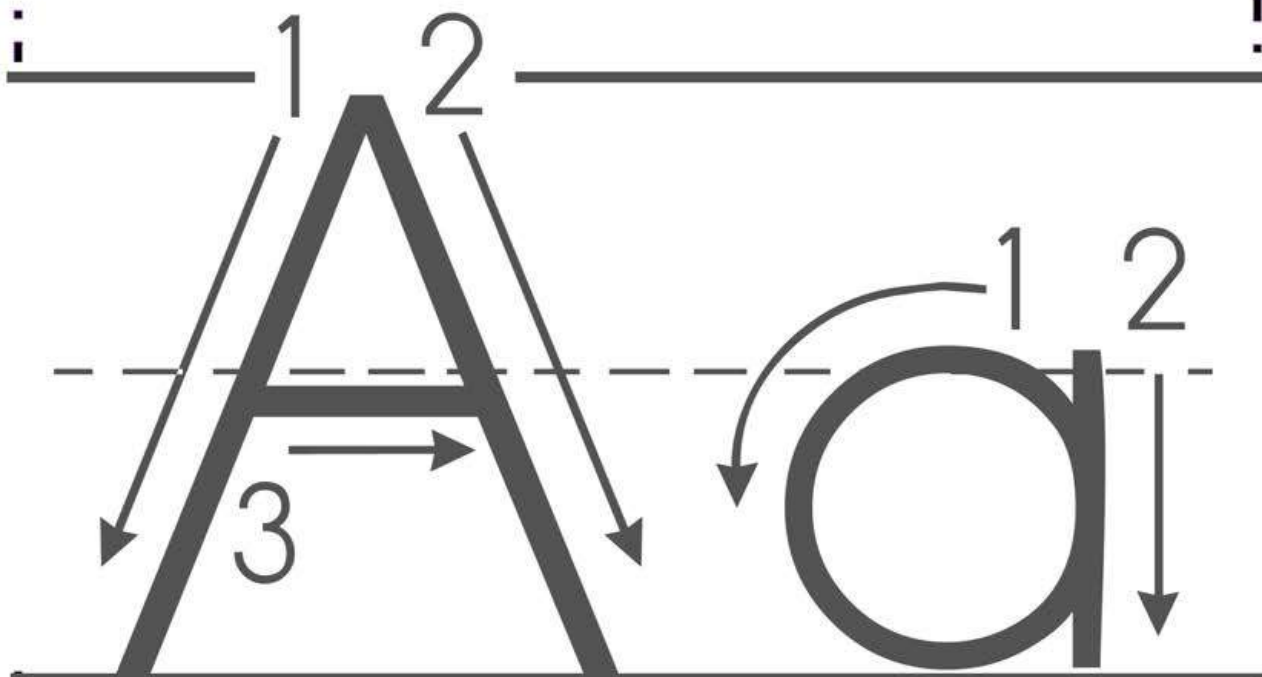

Slide Down

Pick up

Slide Down

Pick up

Across

Around

Pick up

And down

Alpaca

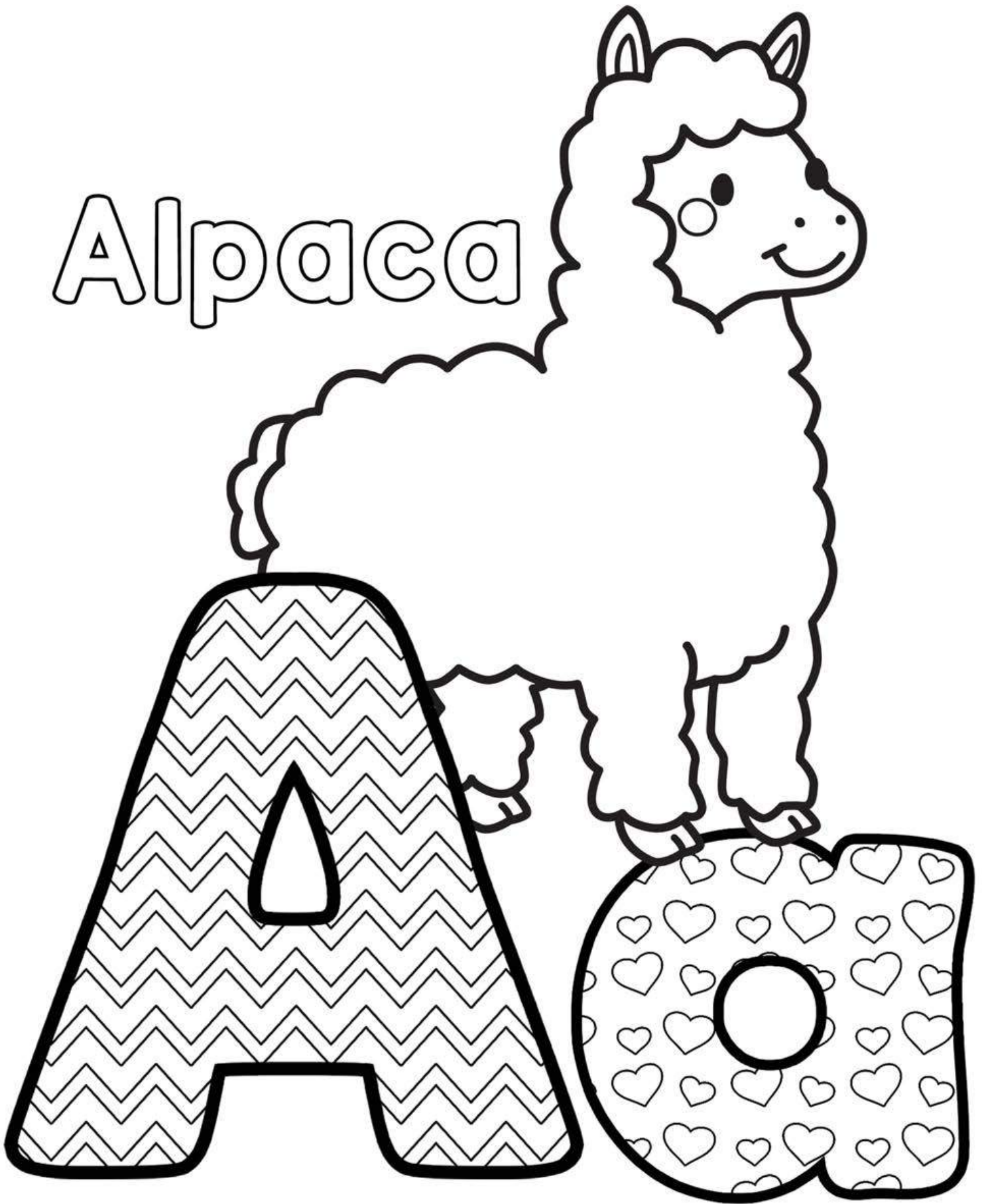

A a

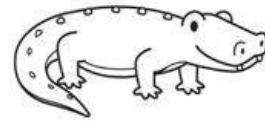
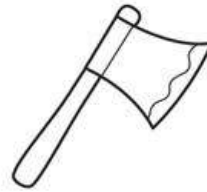
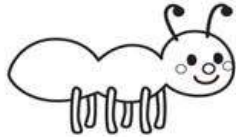
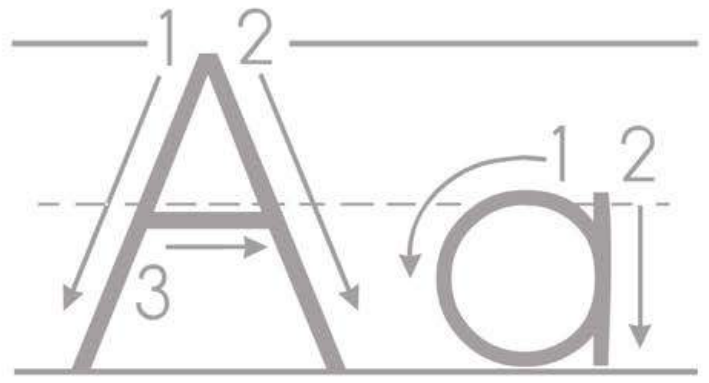

apple

ape

ant

axe

alligator

angel

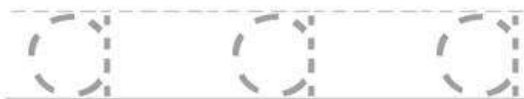
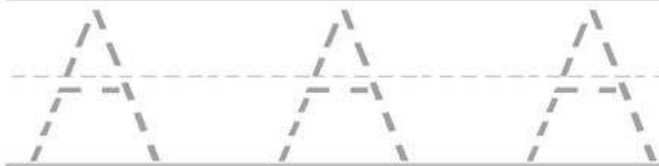
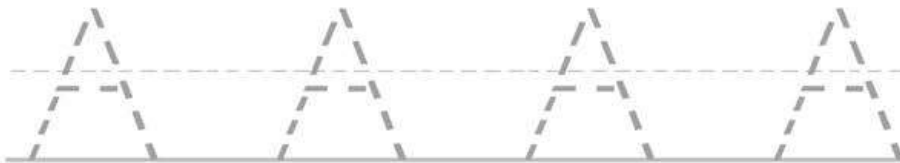

Give the ant six legs:

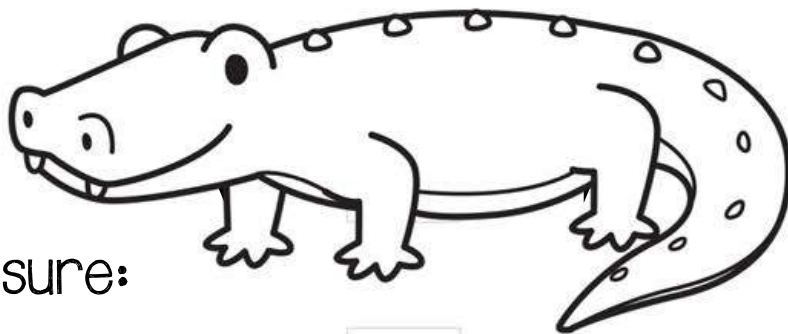
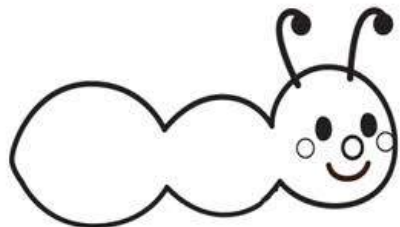

Measure:



Add

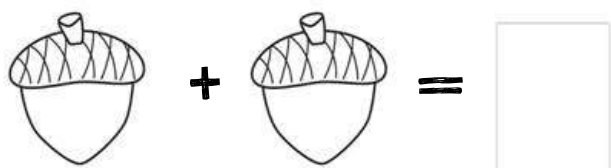

Count & Tally

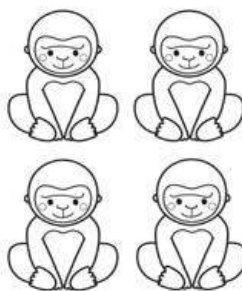

$$1 + 1 = \square$$

$$1 + 2 = \square$$

$$\begin{array}{r} 2 \\ + 1 \\ \hline \square \end{array}$$

$$\begin{array}{r} 1 \\ + 2 \\ \hline \square \end{array}$$

Circle what comes next:

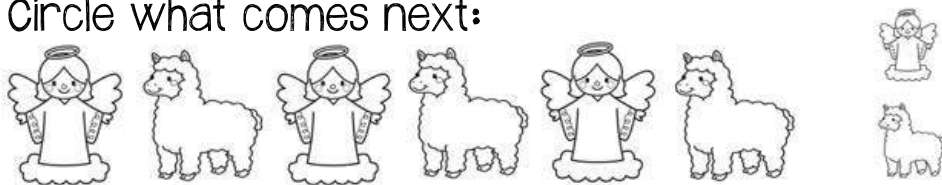

Color the 1st apple. Put an X on the 5th apple.

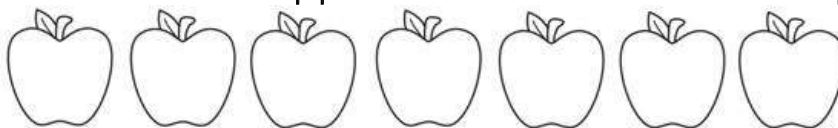

Draw: $2 + 1 = 3$

$$+ =$$

A a

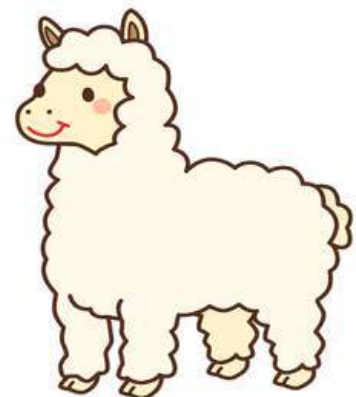
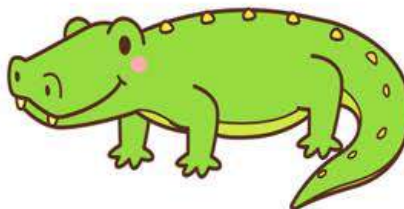
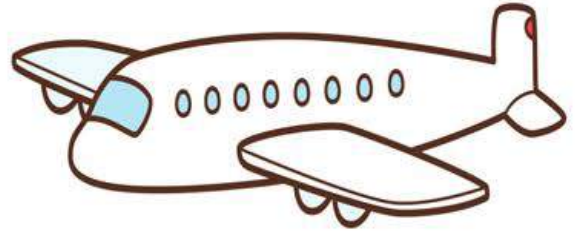

I CAN COLOR

words with:

-  = apple
-  = acorn
-  = angel
-  = alligator
-  = alpaca
-  = ape
-  = ant

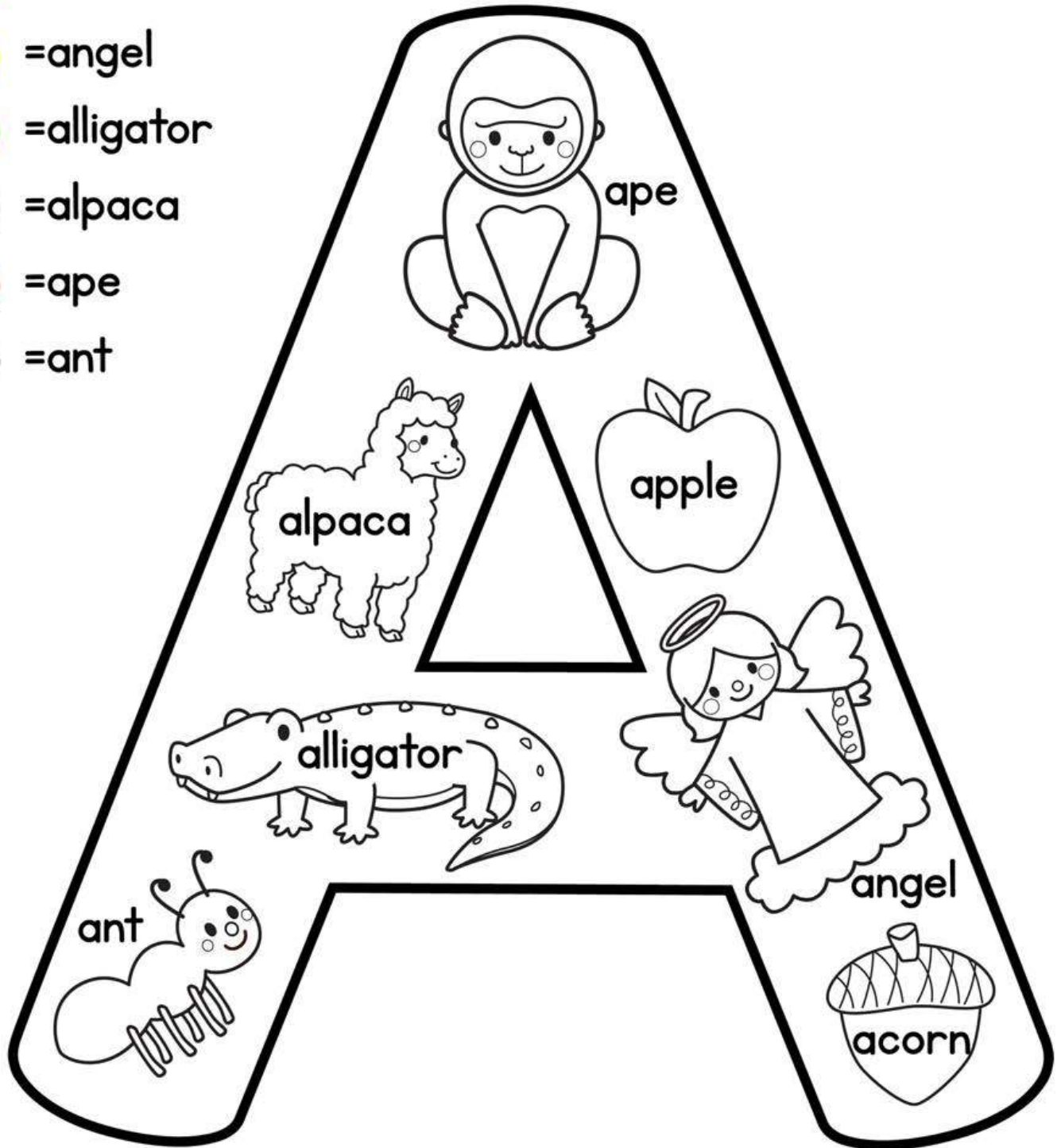

NAME : _____

Aa

Write and read words that begin with letter a.



apple apple

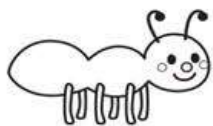

ant ant ant

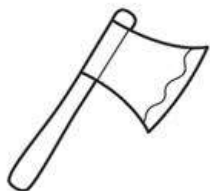

axe axe axe

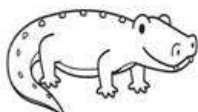

alligator



angel angel



ape ape ape



astronaut

NAME : _____

Aa

Write and read words that begin with letter a.



Apple Apple

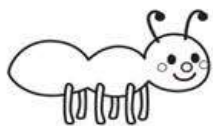

Ant Ant Ant



Axe Axe Axe



Alligator



Angel Angel

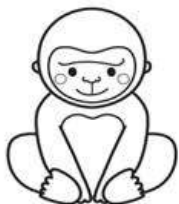

Ape Ape Ape



Astronaut

NAME : _____

RACE TO THE TOP

Use a paperclip and a pencil to complete the spinner.

A	a
A	a
A	a
A	a
A	a
A	a
A	a
A	a
A	a
A	a

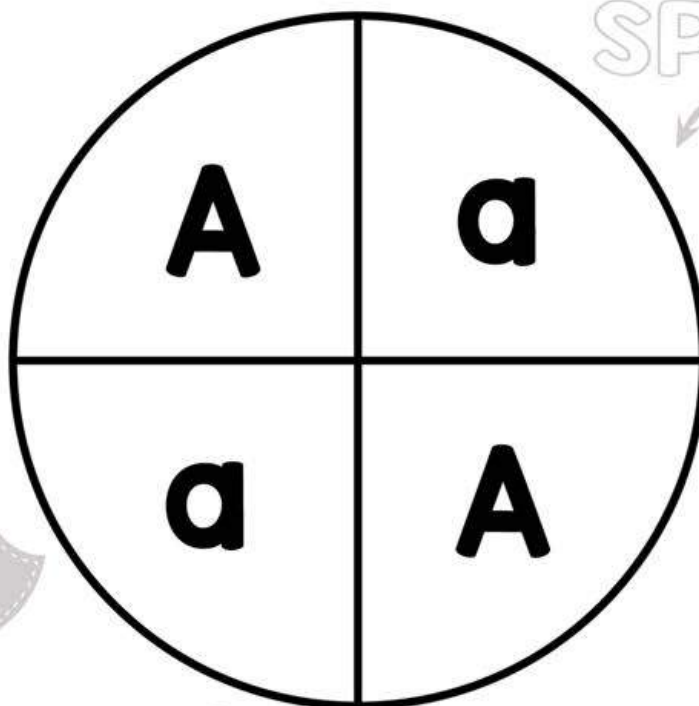

SPIN



Record

Report:

How many spins landed on A?

How many spins landed on a?

Which had more?

Write an inequality: >

How many spins total?

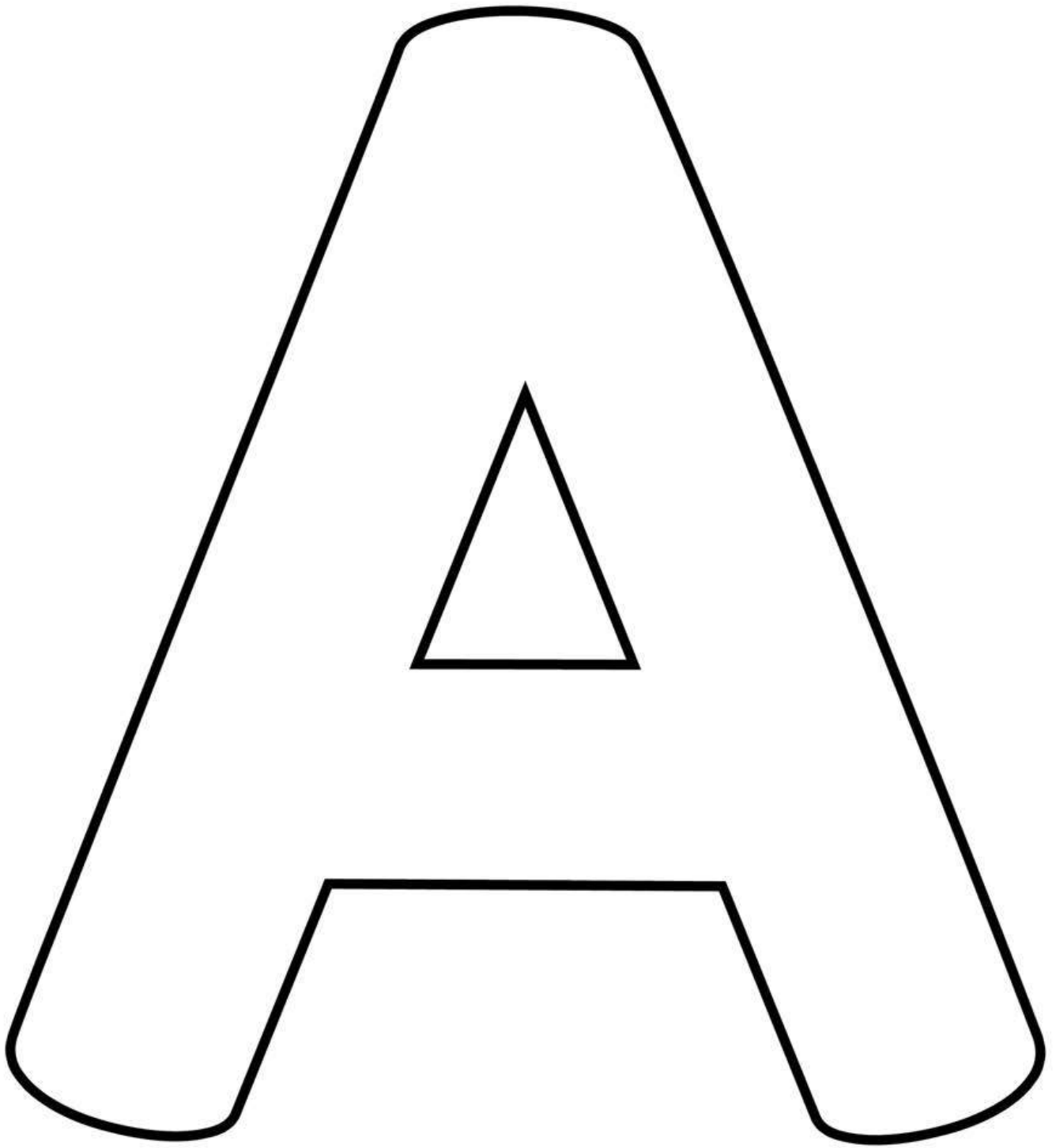

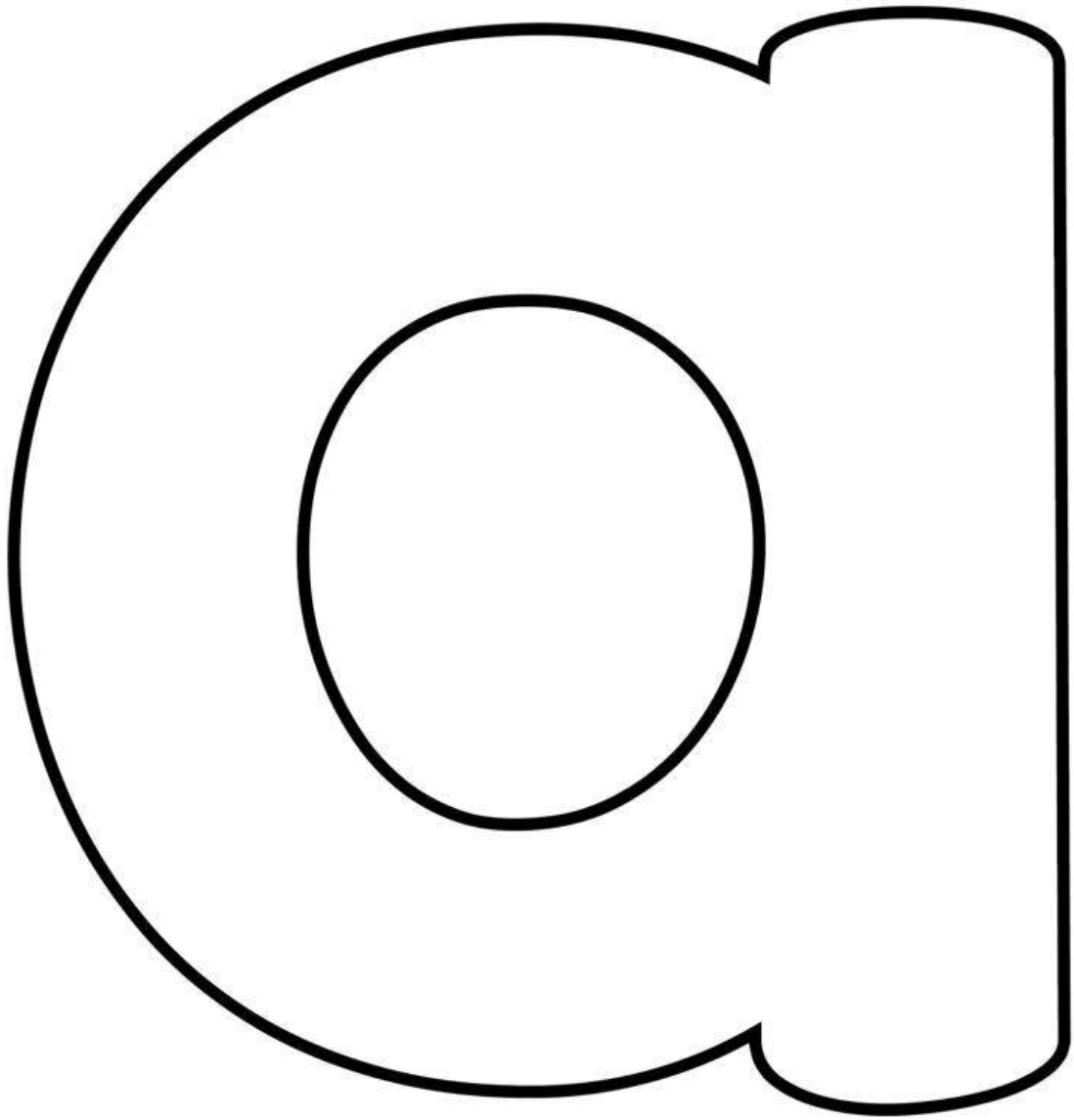



I C A N F I N D

the letter:

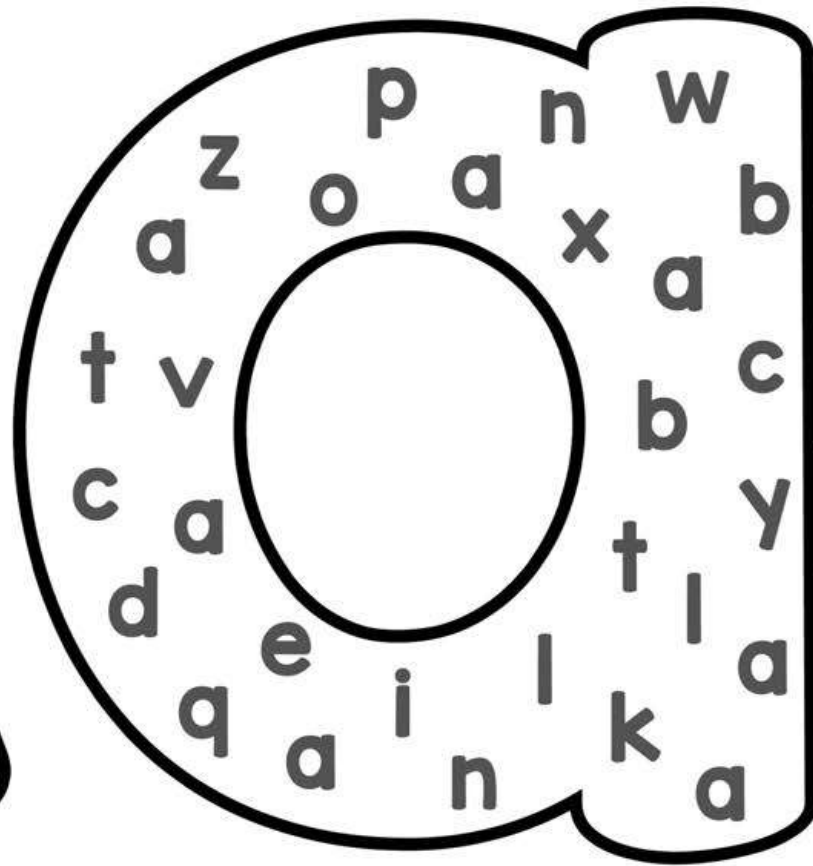
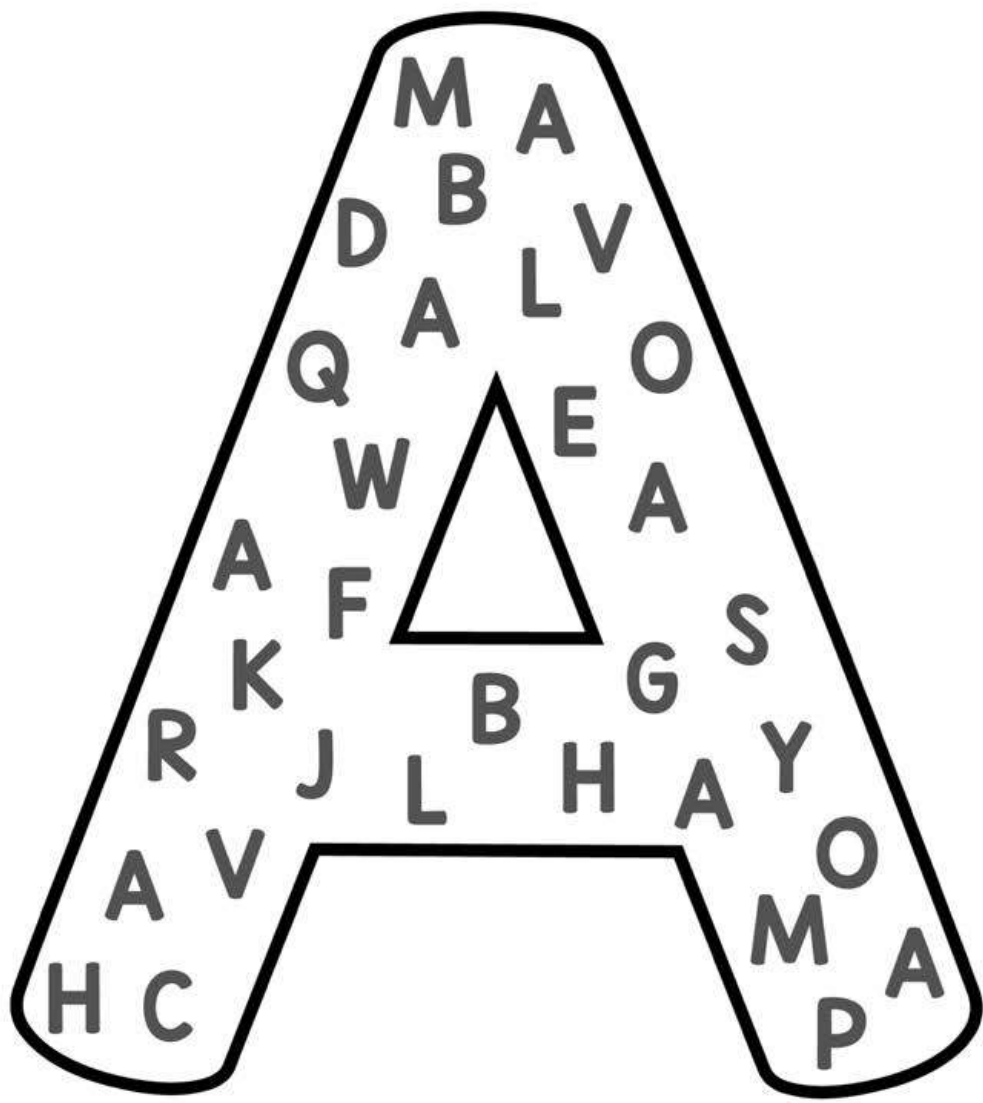

How Many?

How Many?

TRACE

NAME : _____

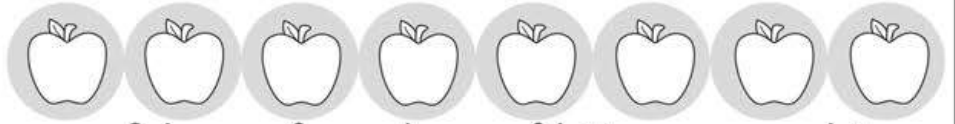





Color one for each row of letters you complete

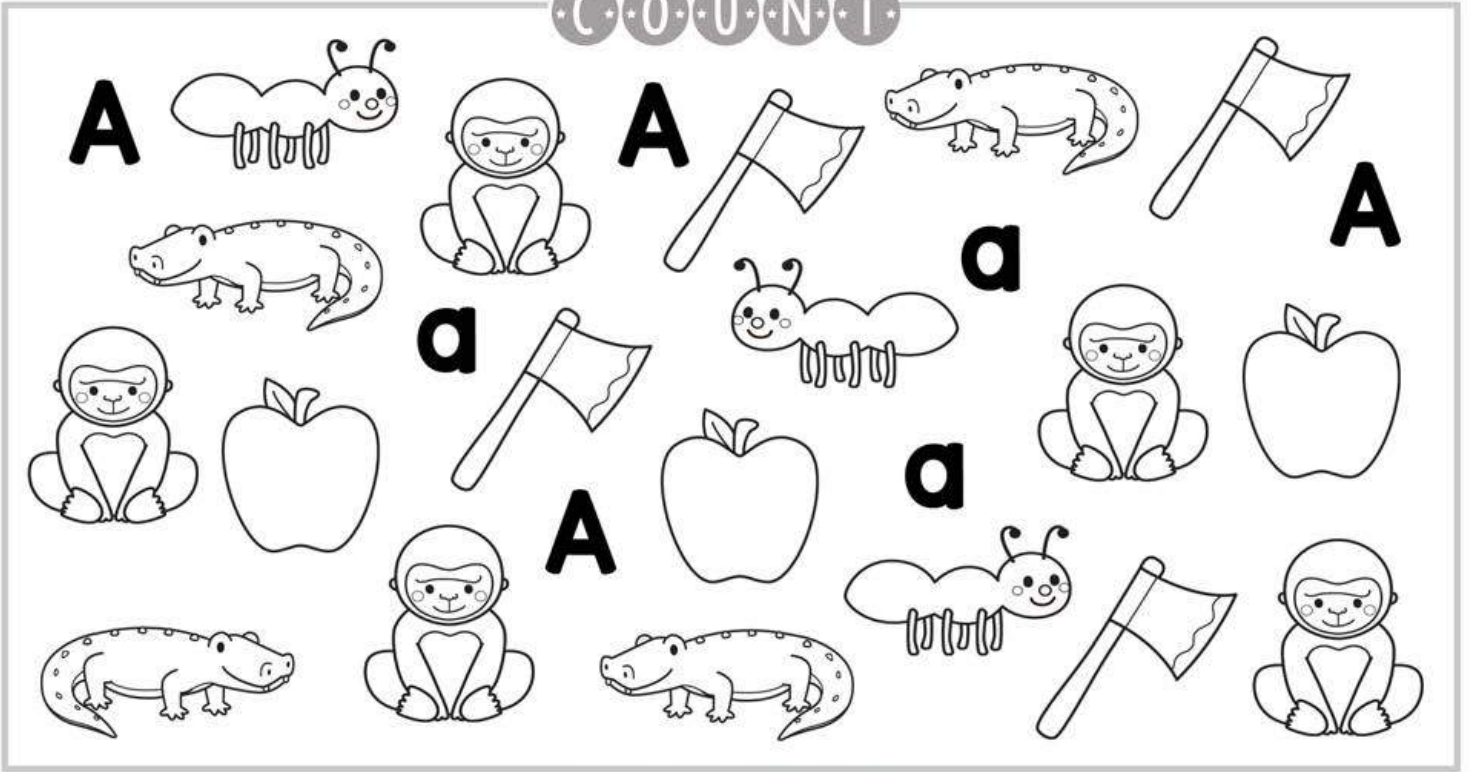

C · O · U · N · T ·

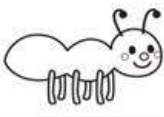

G · R · A · P · H ·

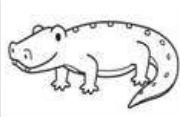
A	a					

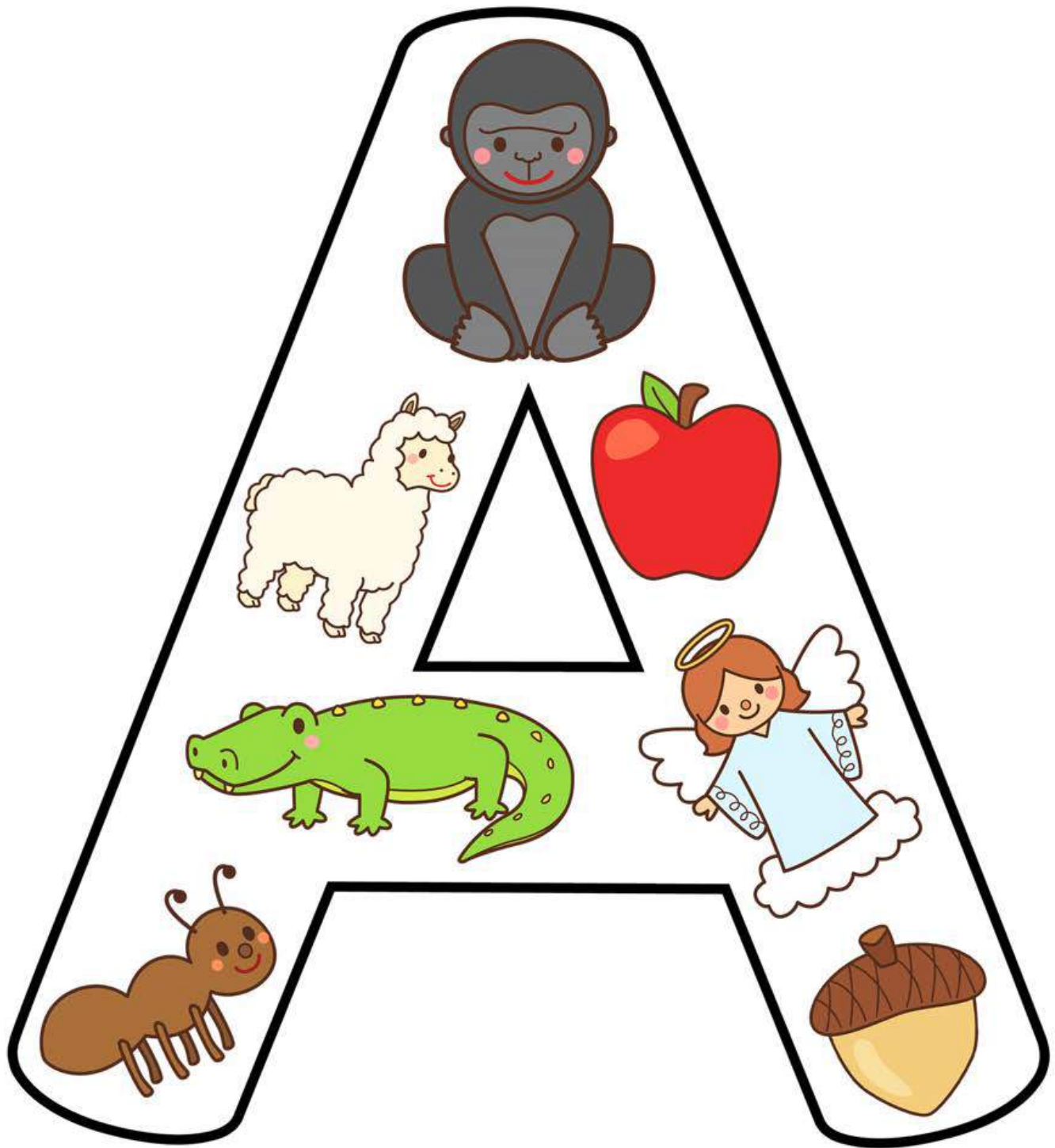

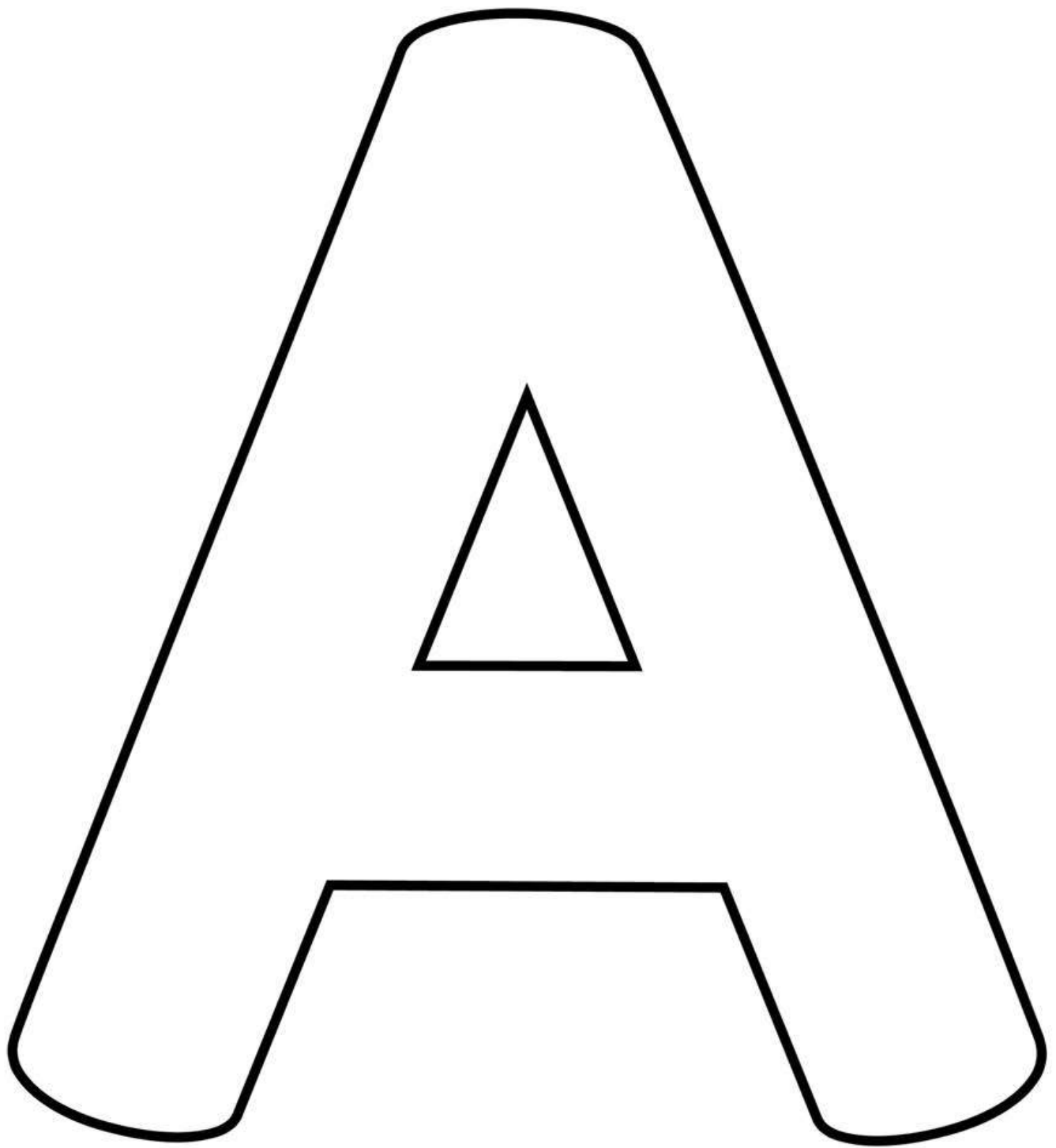

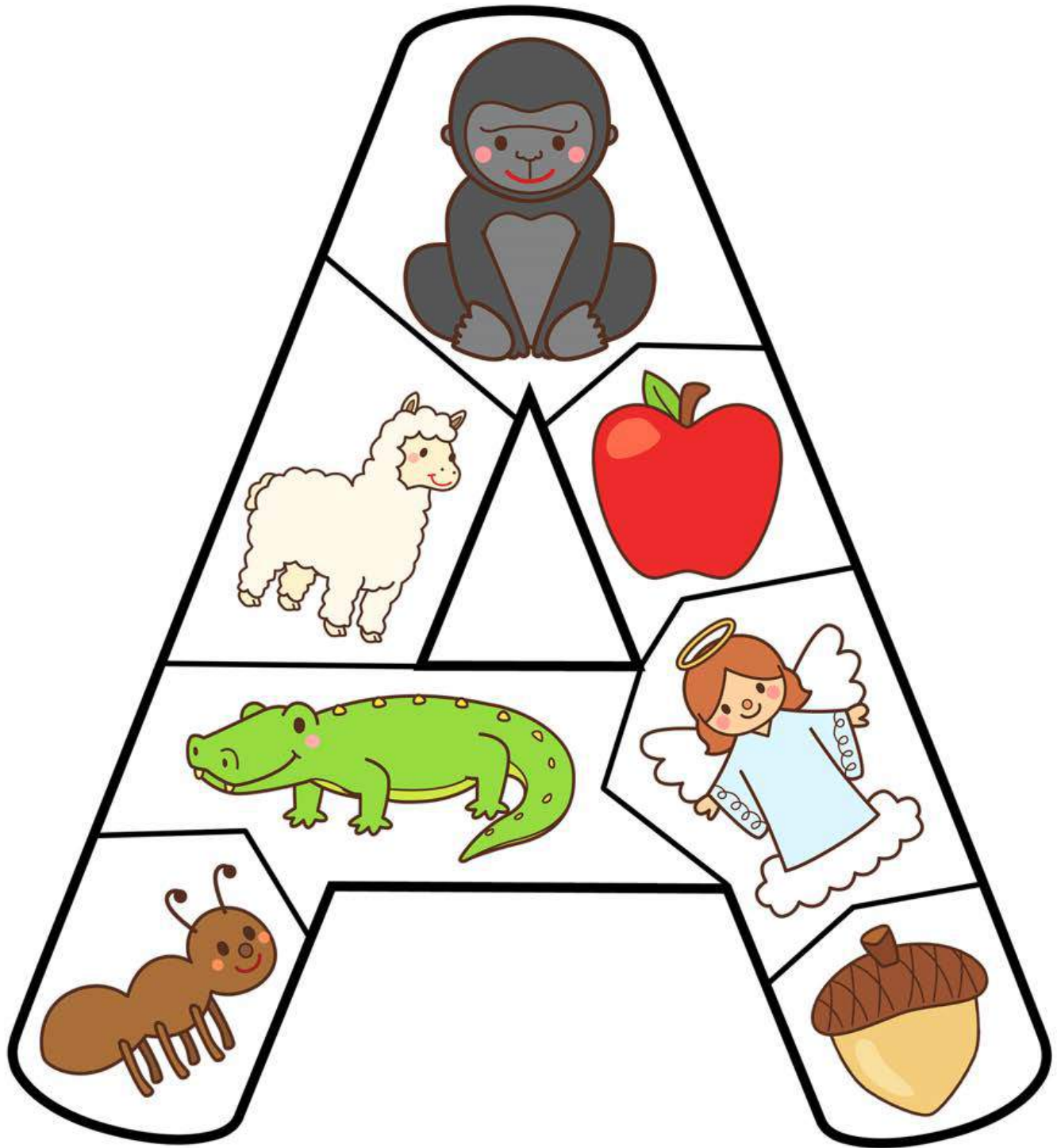

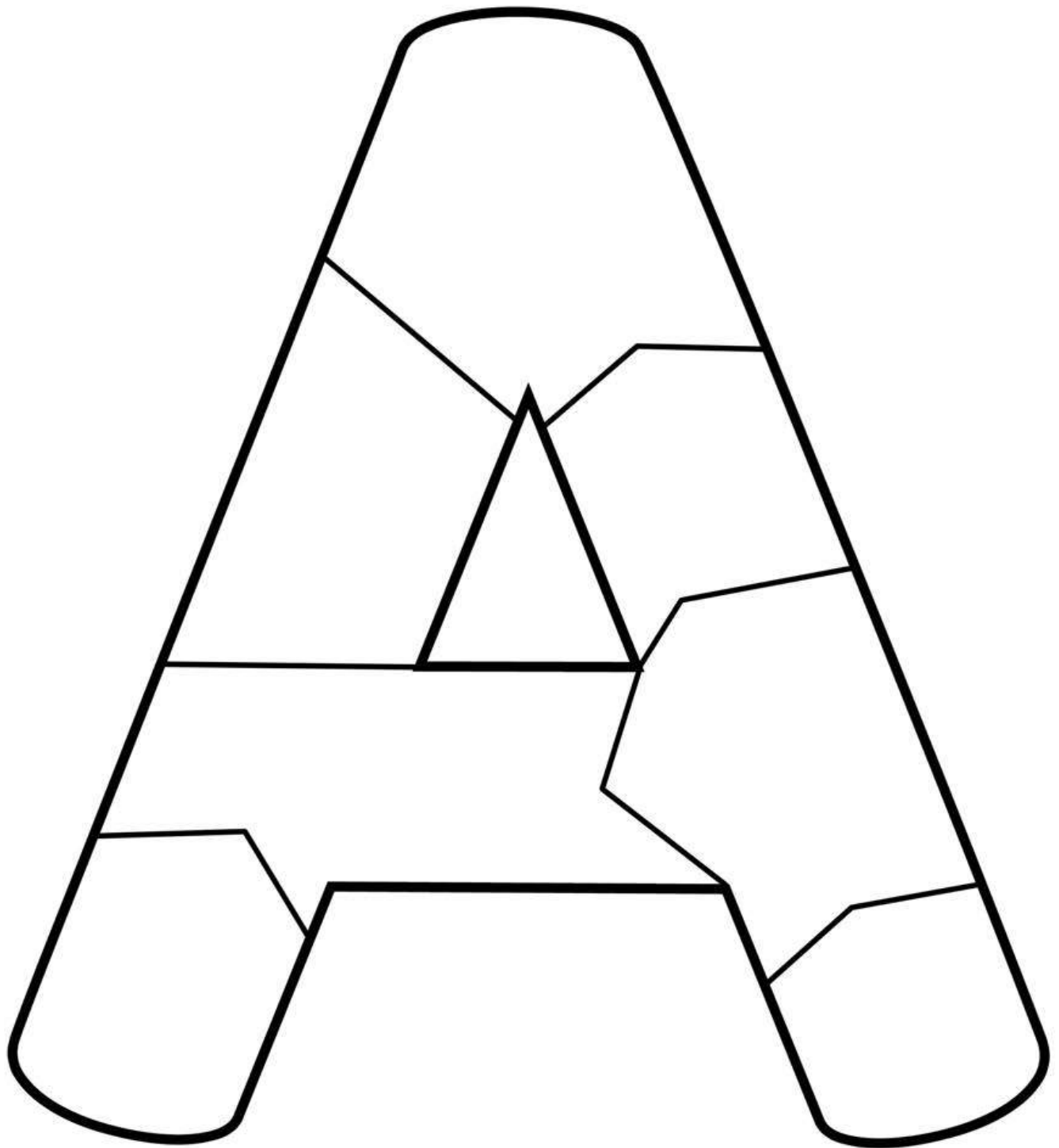

1. Write

2. Cut Out 

NAME : _____

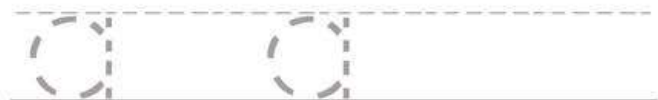

A B C Q U I L T

3. Color

4. Cut out 

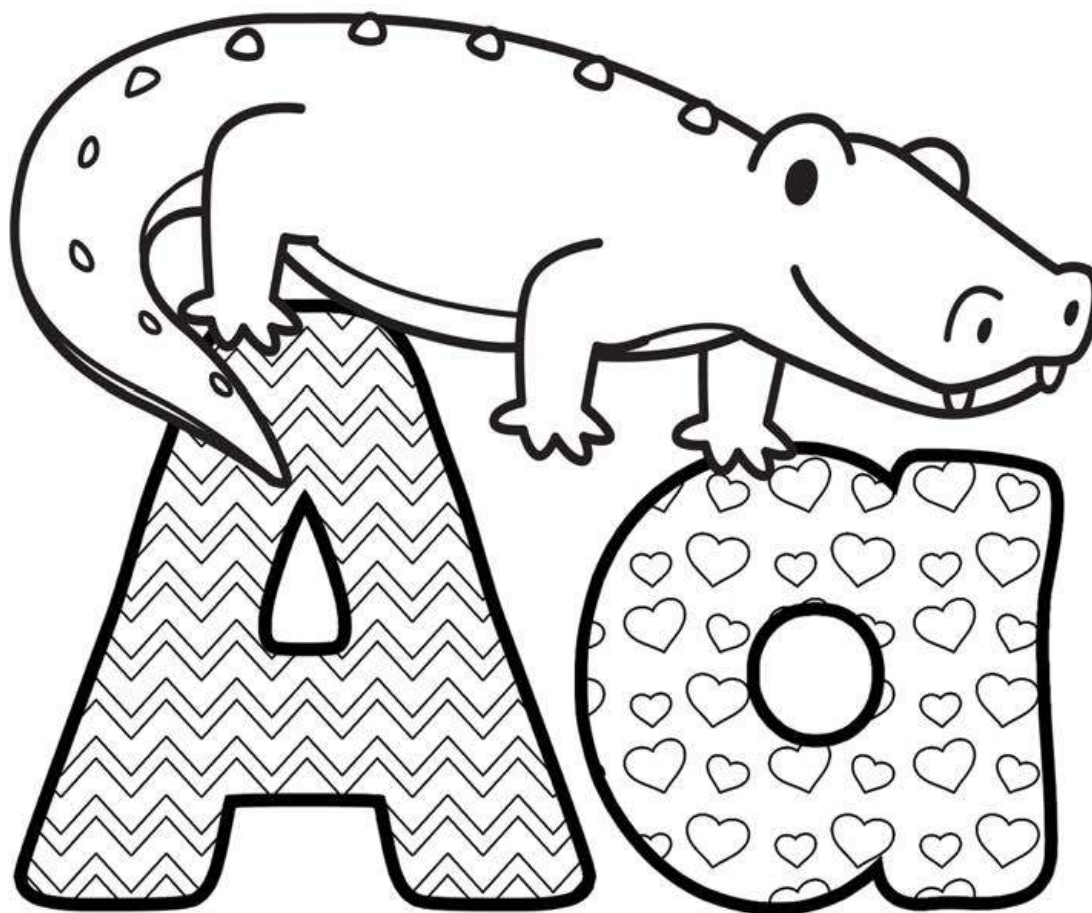

NAME : _____

NAME : _____

Aa

Write and read words that begin with letter a.



apple apple

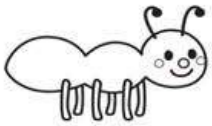

ant ant ant



axe axe axe

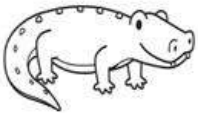

alligator



angel angel

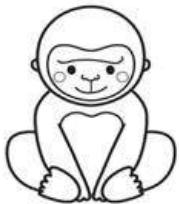

monkey monkey monkey



astronaut



apple



axe

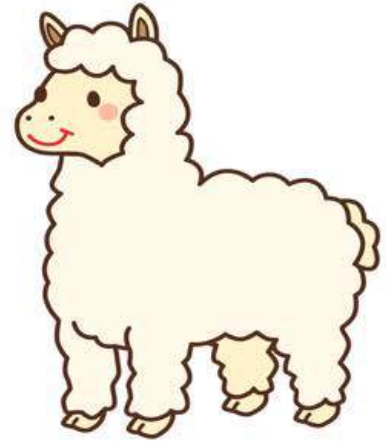

alpaca

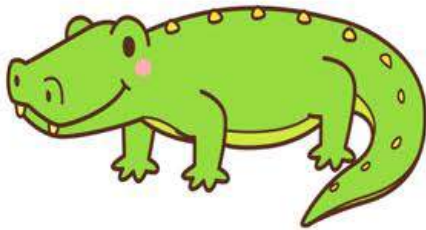

alligator



angel



ape

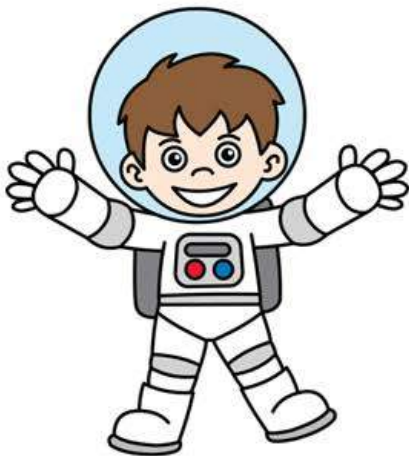

astronaut



anchor





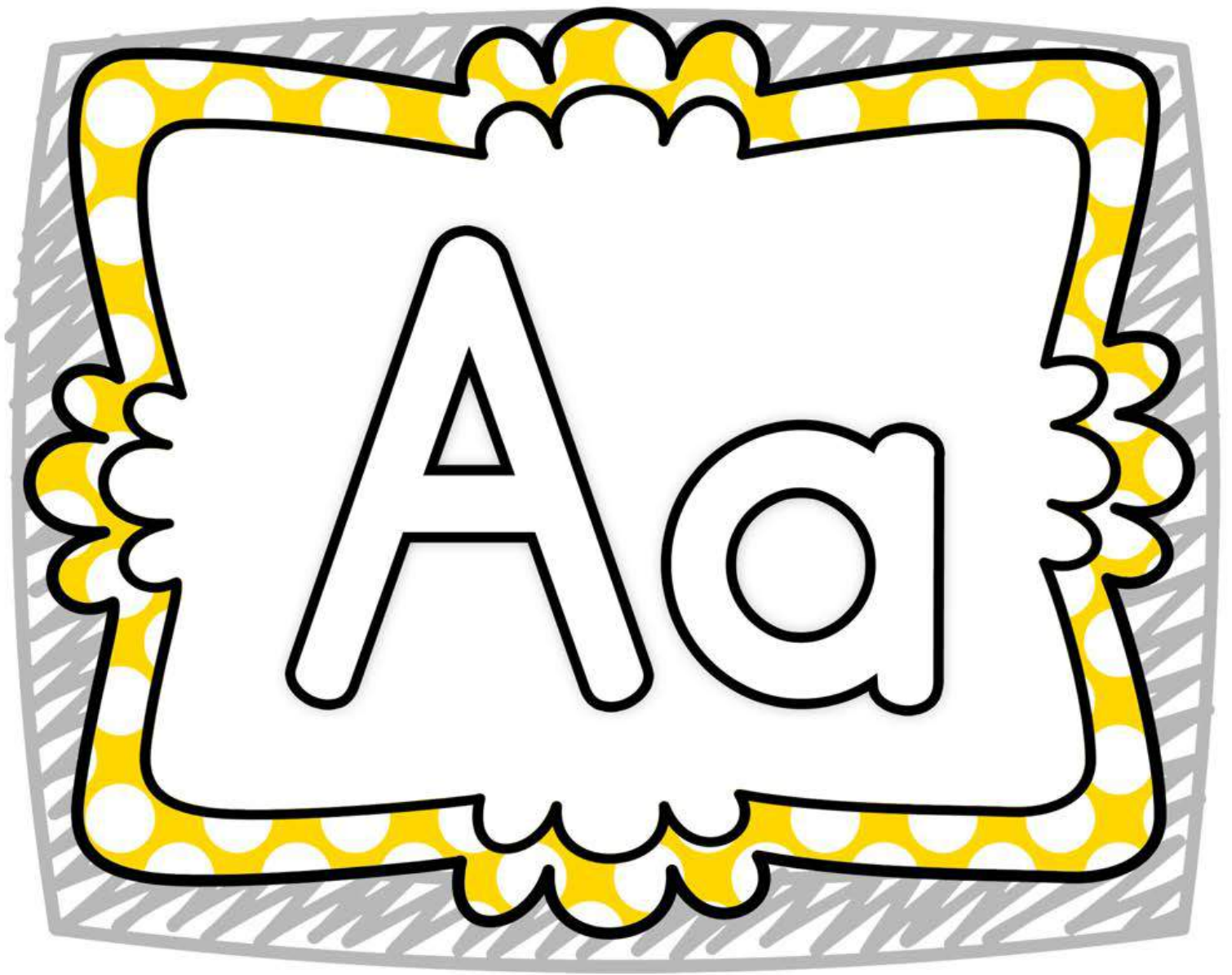











ant

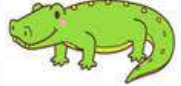

LETTER A

4













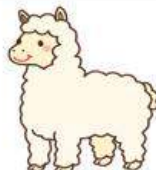

IN A ROW

LETTER A

4



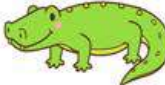
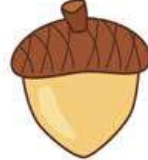













IN A ROW

LETTER A



















4 IN A ROW

LETTER A



4 IN A ROW

I CAN WRITE

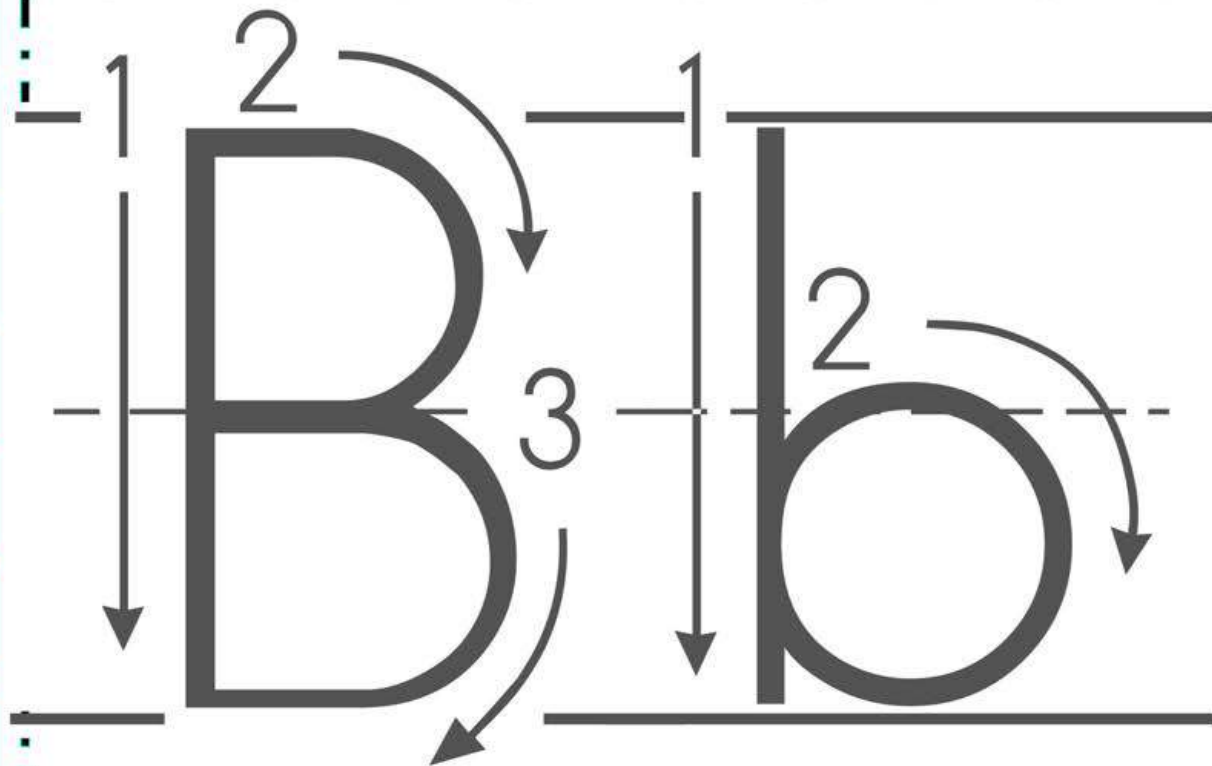

Line Down

Pick up

Big Belly

Big Belly

Line Down

Pick up

Little Belly

Balloons

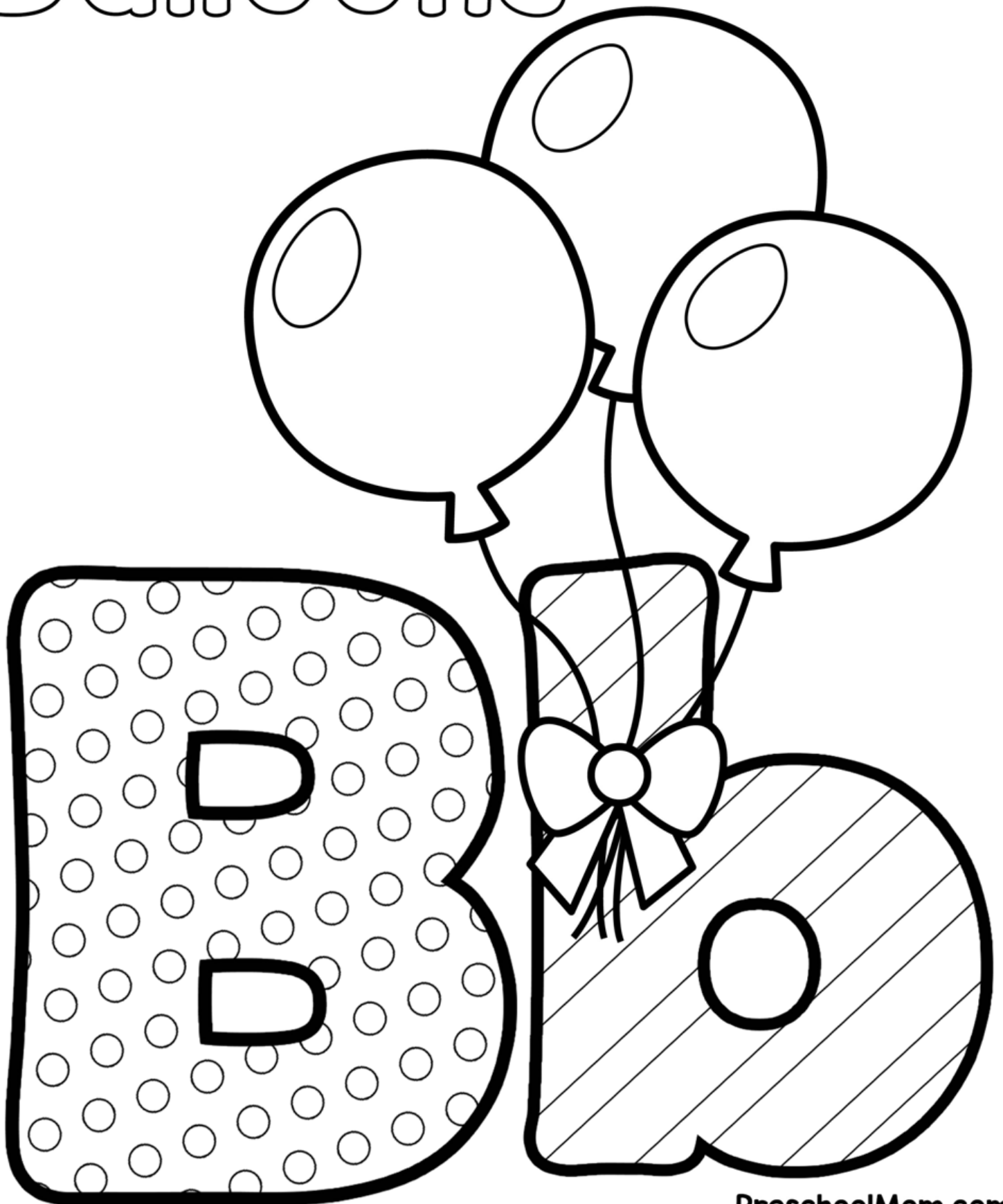

B b

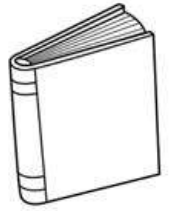
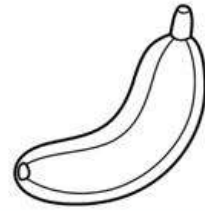
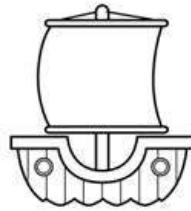
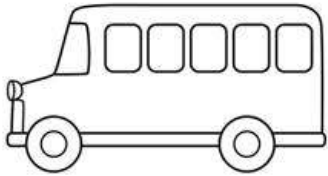
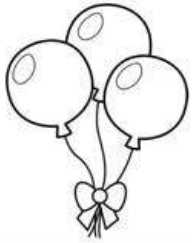
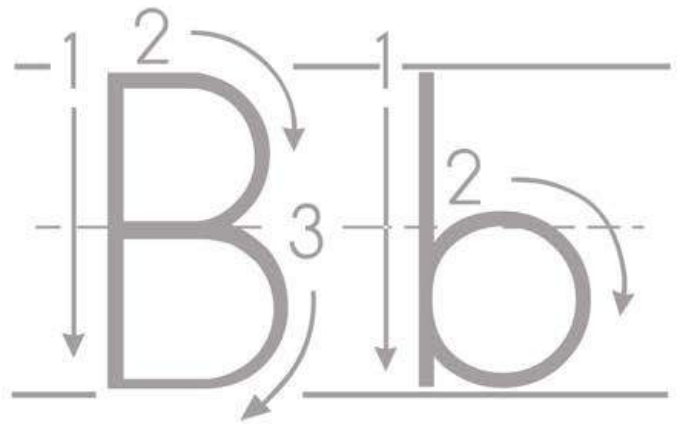

balloons

bus

bell

boat

banana

book

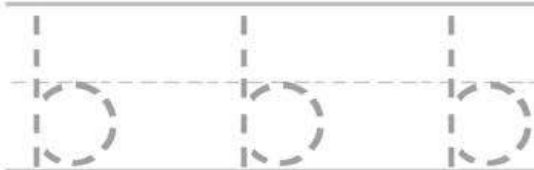
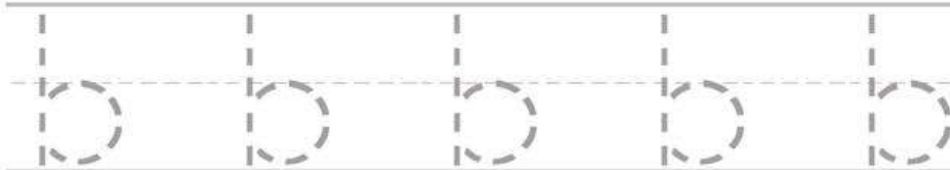
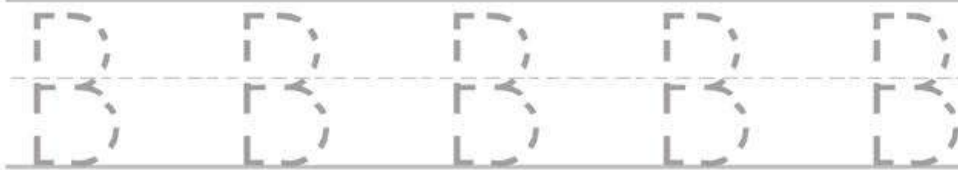
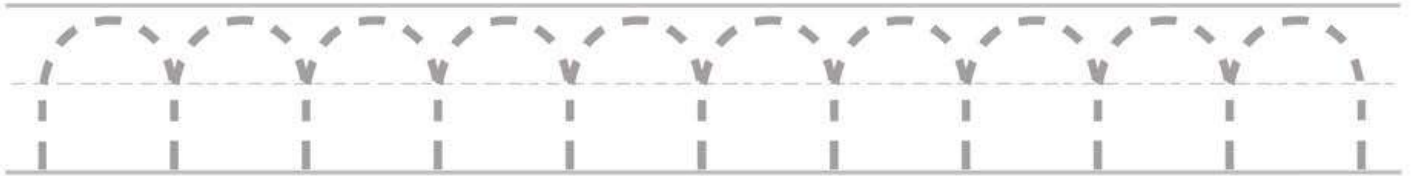

Draw three balloons:

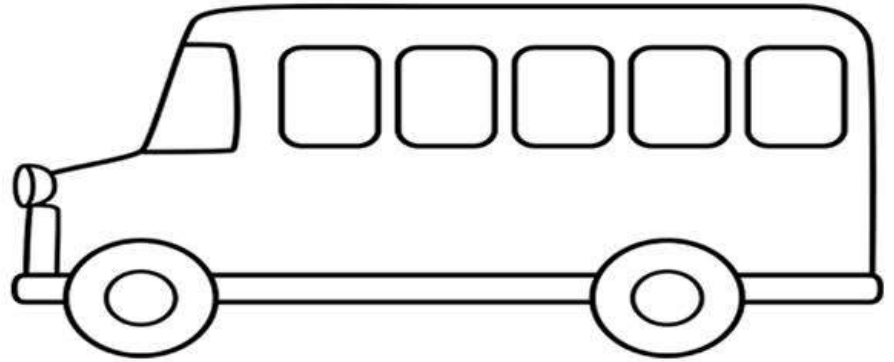
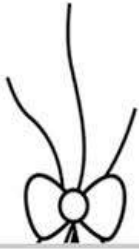

Measure:

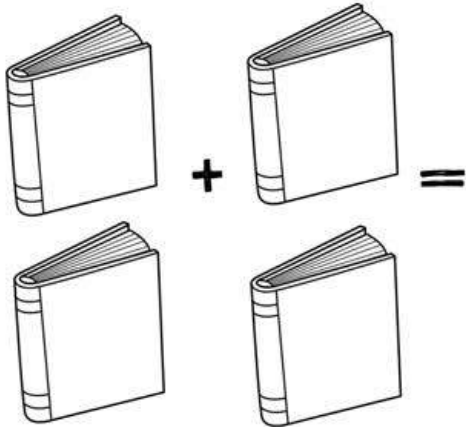

Add

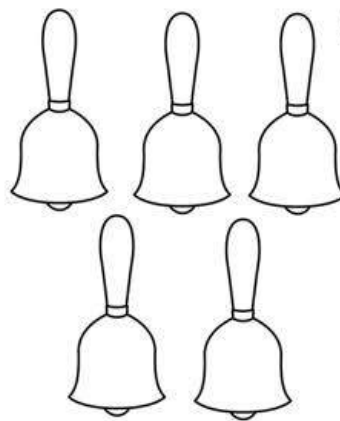

Count & Tally

$$2 + 1 = \square$$

$$2 + 2 = \square$$

$$\begin{array}{r} 2 \\ + 2 \\ \hline \square \end{array} \quad \begin{array}{r} 1 \\ + 2 \\ \hline \square \end{array}$$

Circle what comes next:



Color the 2nd banana. Put an X on the 6th banana.

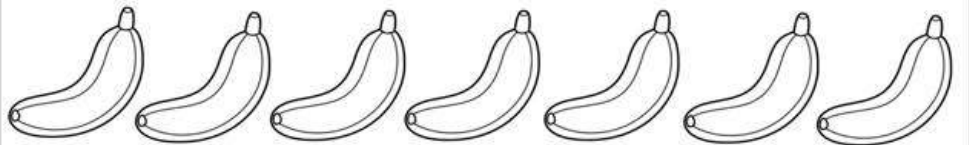

Draw: $3 + 1 = 4$

$$+ =$$



Bb

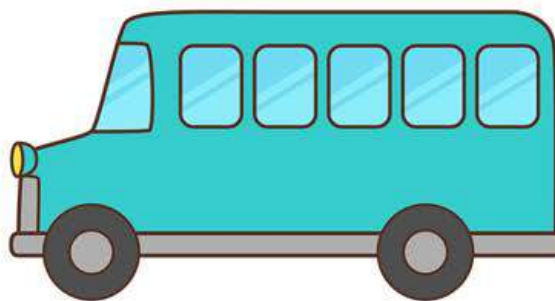



I CAN COLOR

 = balloons

 = bus

 = bee

 = book

 = boat

 = belt

 = ball

 = bell

 = brush

words with:

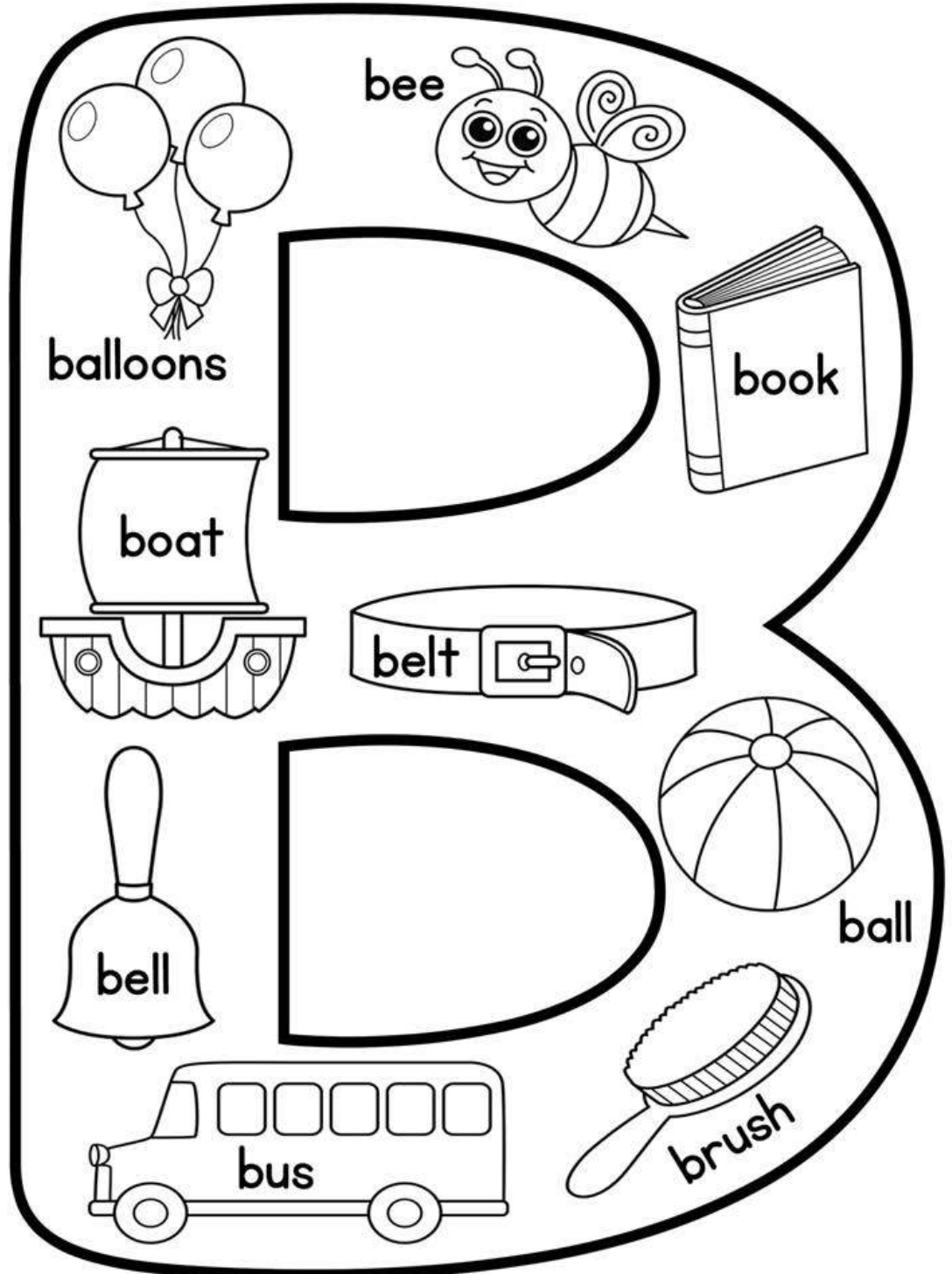

NAME : _____

Bb

Write and read words that begin with letter b.

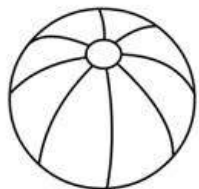

ball ball ball



bee bee bee

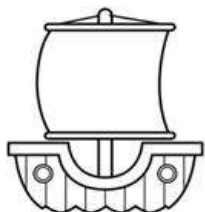

boat boat

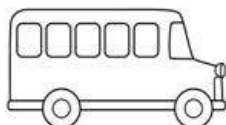

bus bus bus

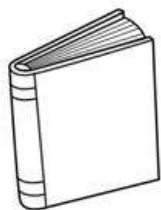

book book



brush brush



bear bear

NAME : _____

Bb

Write and read words that begin with letter b.

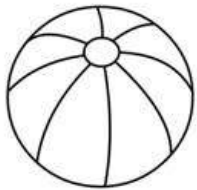

Ball Ball Ball



Bee Bee Bee

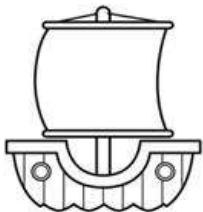

Boat Boat

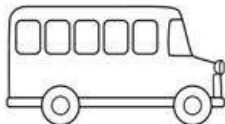

Bus Bus Bus



Book Book



Brush Brush



Bear Bear

NAME : _____

RACE TO THE TOP

Use a paperclip and a pencil to complete the spinner.

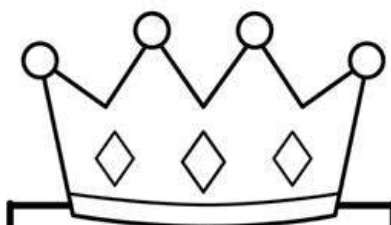

B	b
B	b
B	b
B	b
B	b
B	b
B	b
B	b
B	b
B	b
B	b

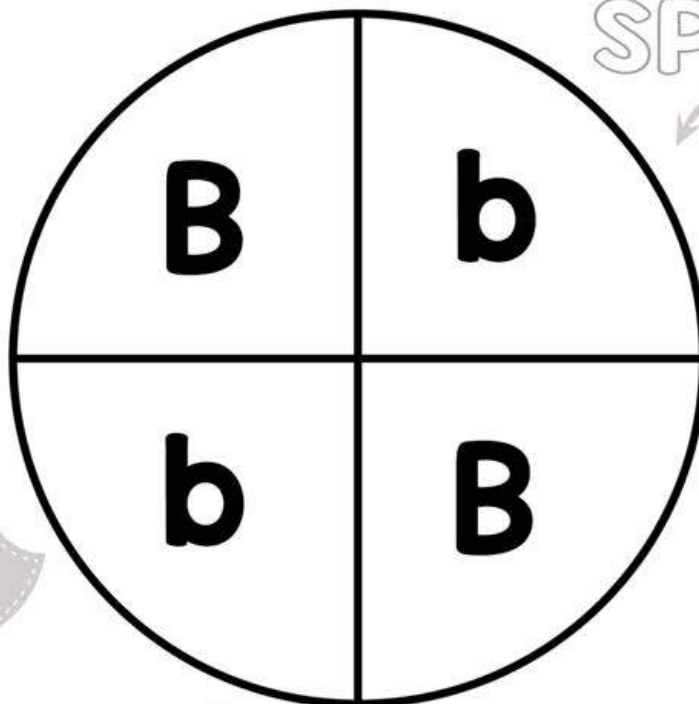

Record

Report:

How many spins landed on B?

How many spins landed on b?

Which had more?

Write an inequality: >

How many spins total?

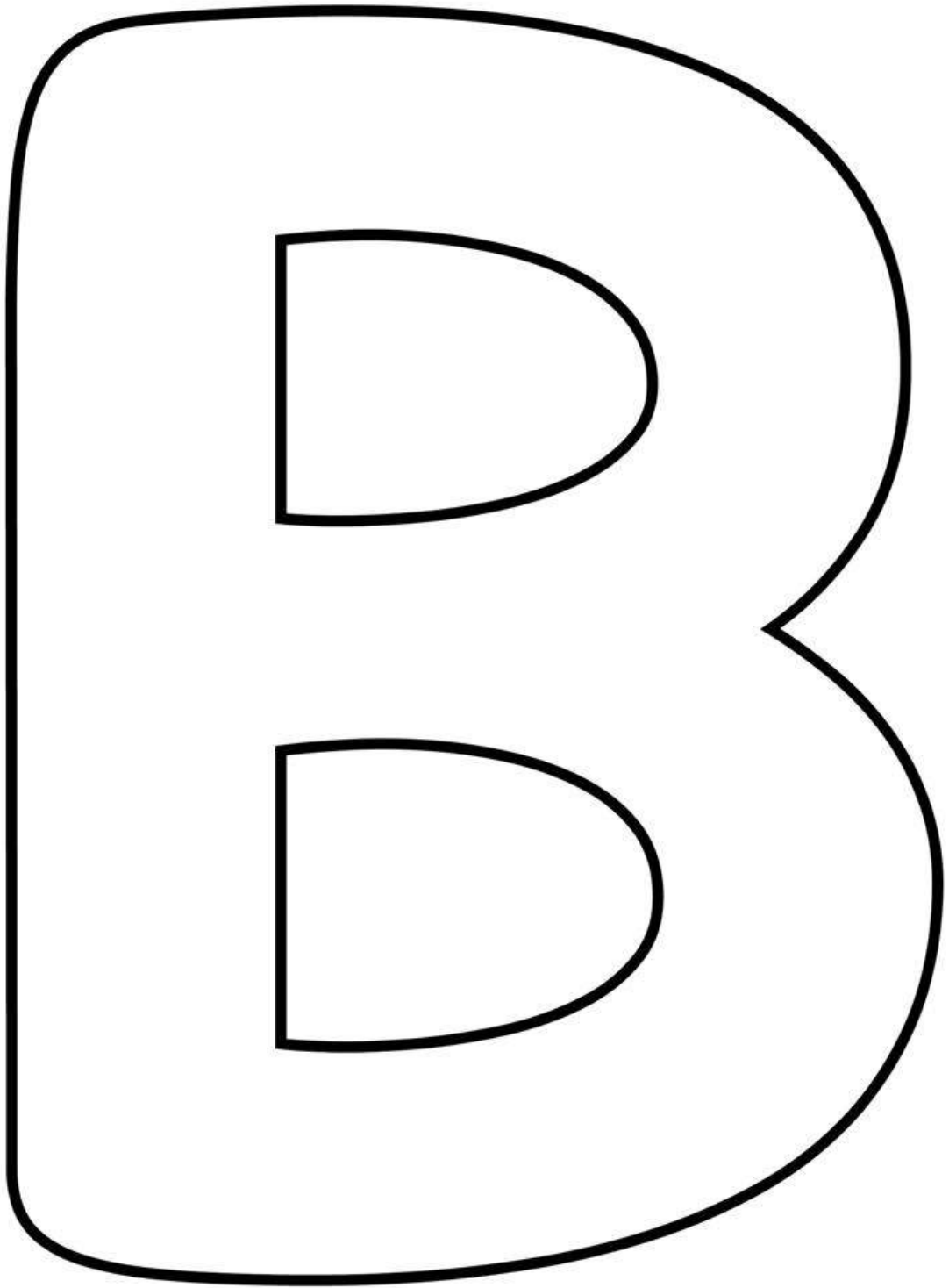

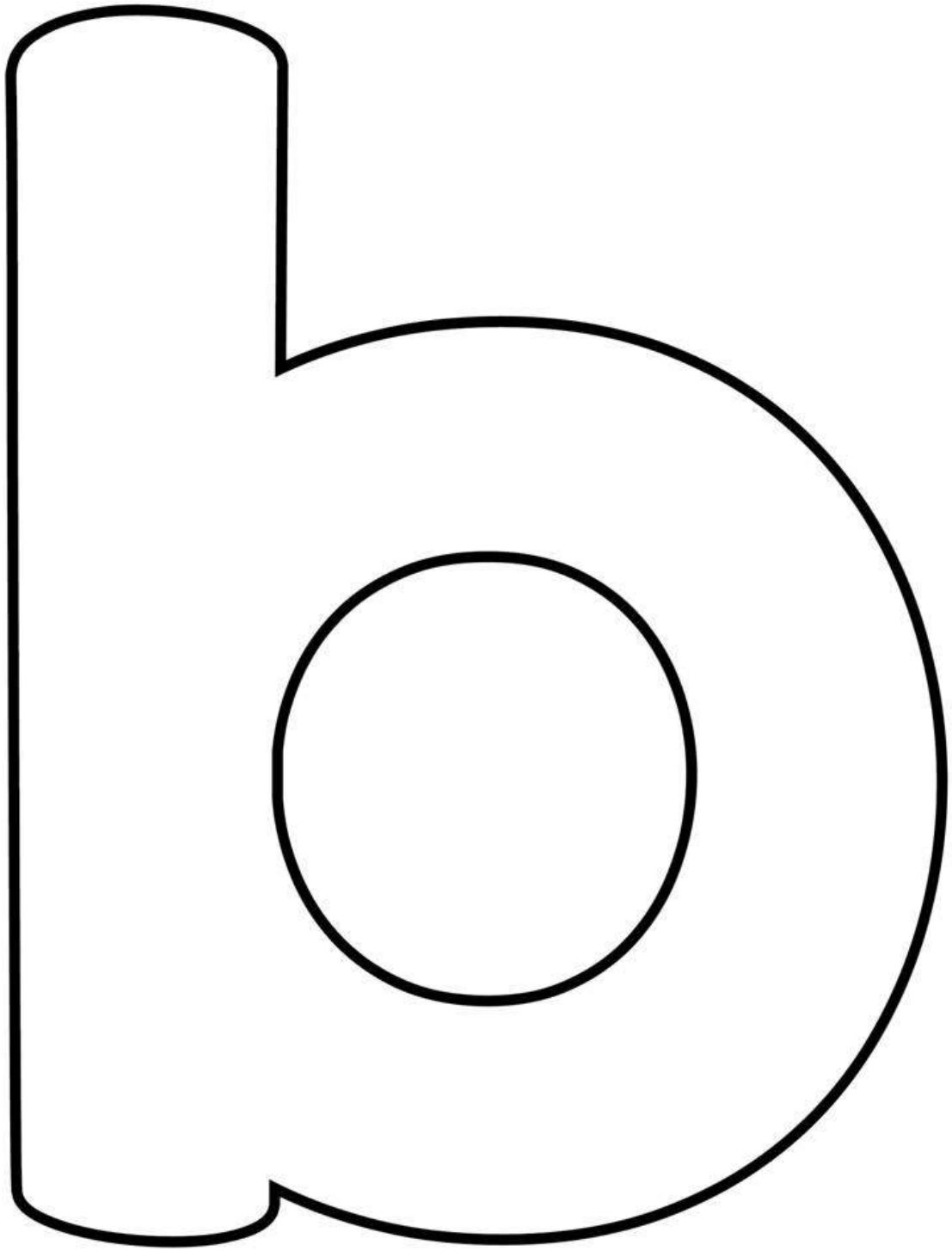

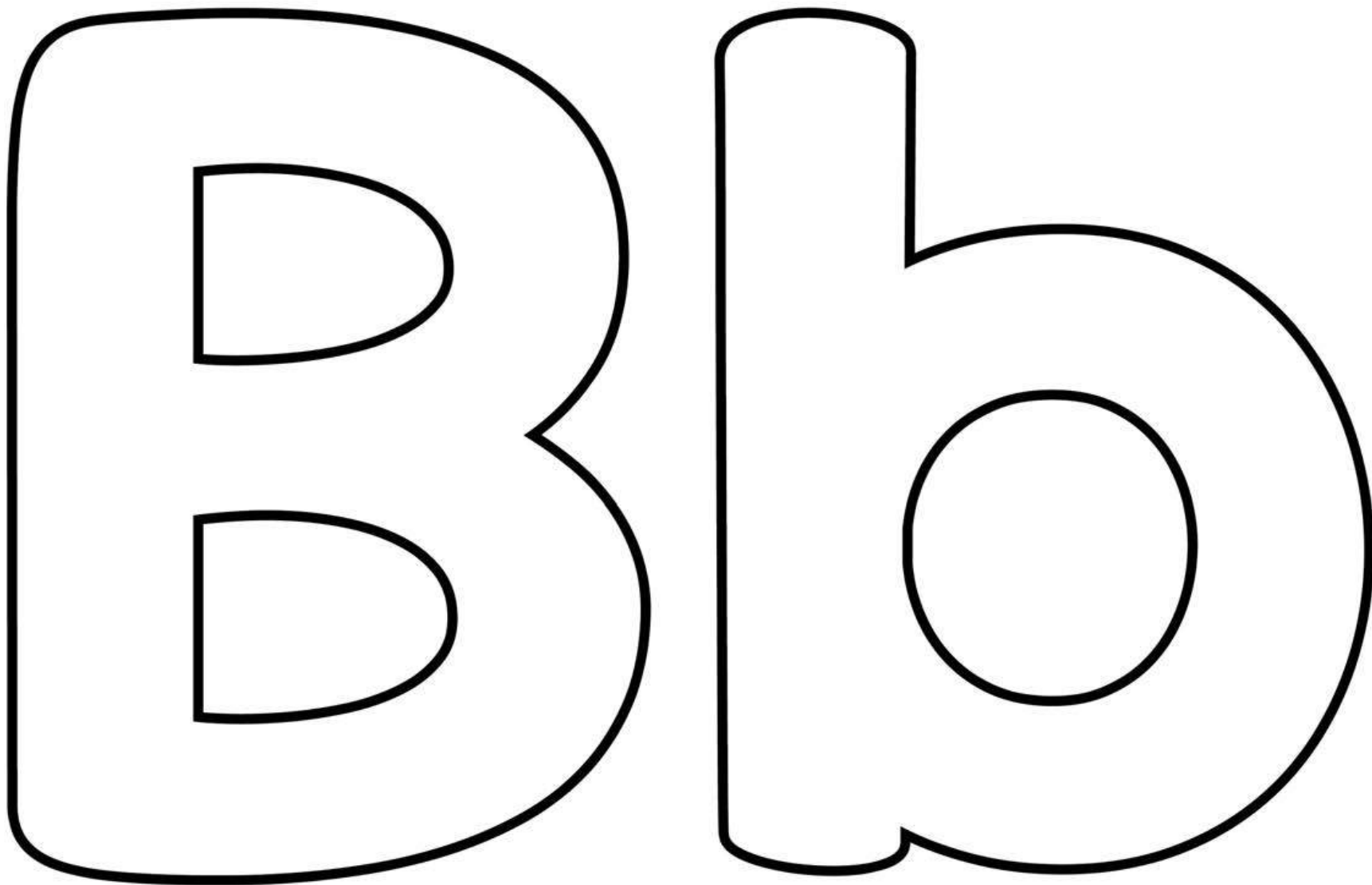

I C A N

F I N D

the letter:

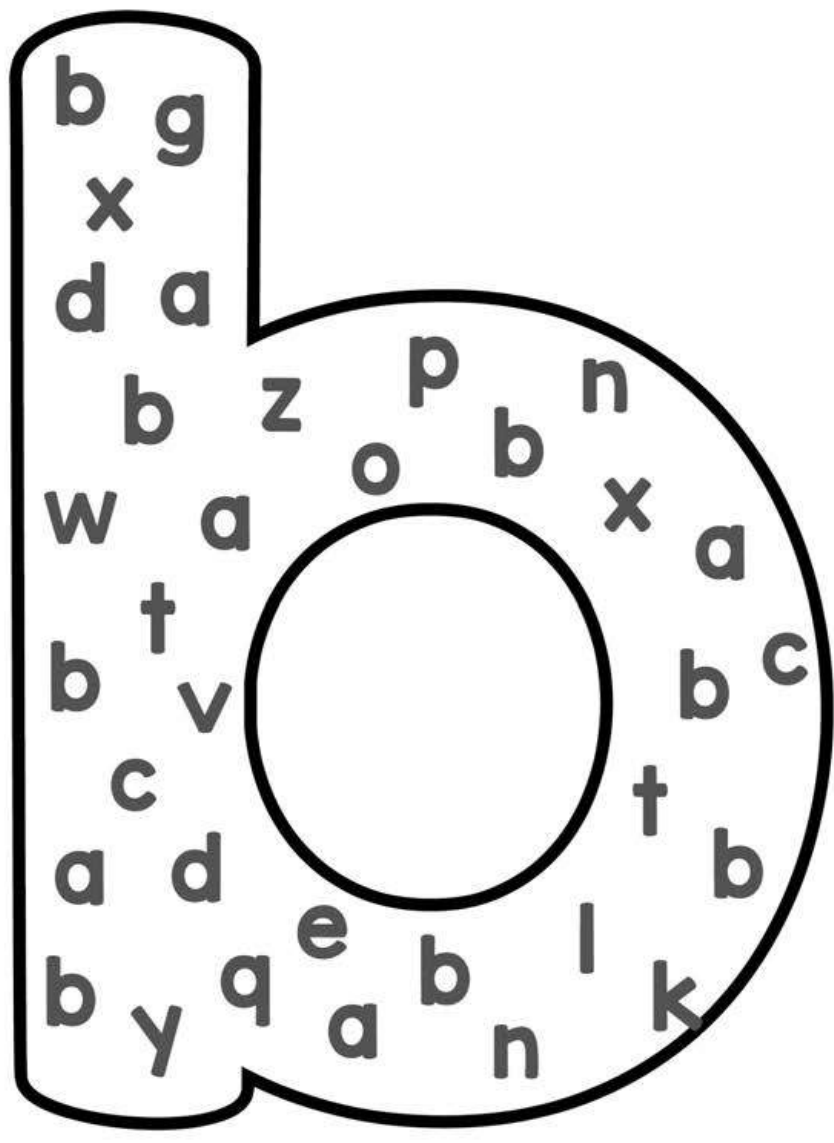
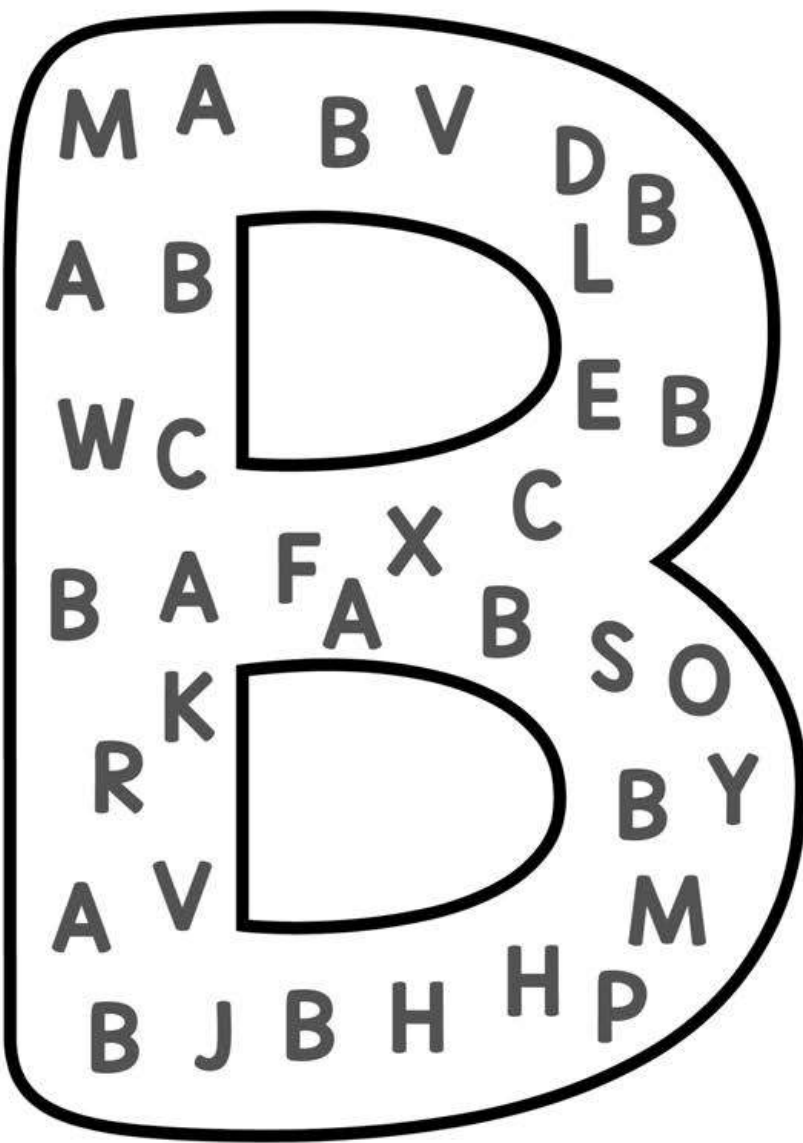

How Many?

How Many?

NAME : _____

TRACE



Color one for each row of letters you complete

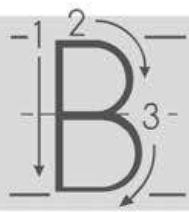

B B B B B B B

B B B B B B B B

B B B B B B B B

• • • • • • • •



b b b b b b b

b b b b b b b





b b b b b b b

• • • • • • • •

C · O · U · N · T ·

B b B b B b B b

G · R · A · P · H ·

B	b					

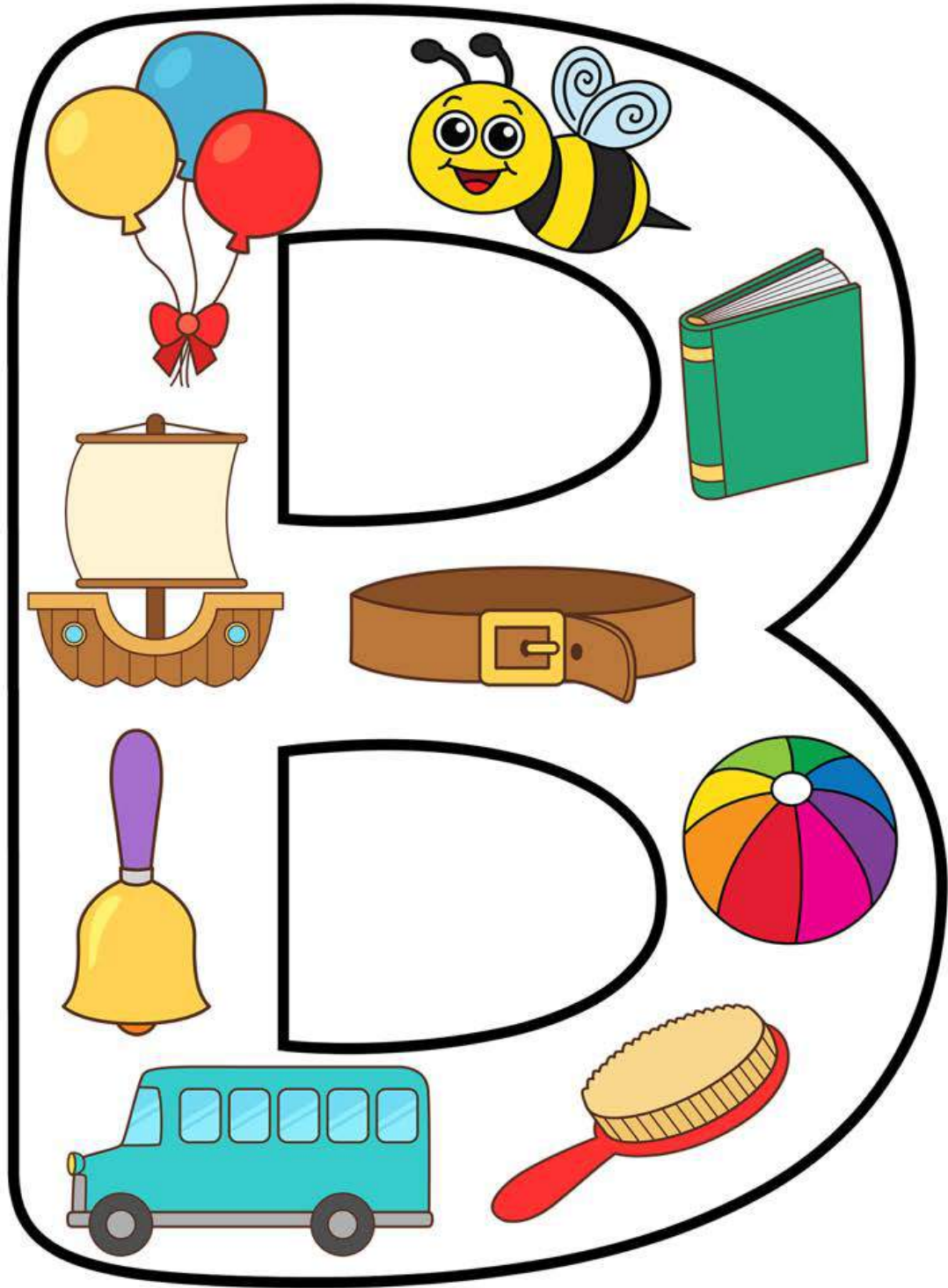

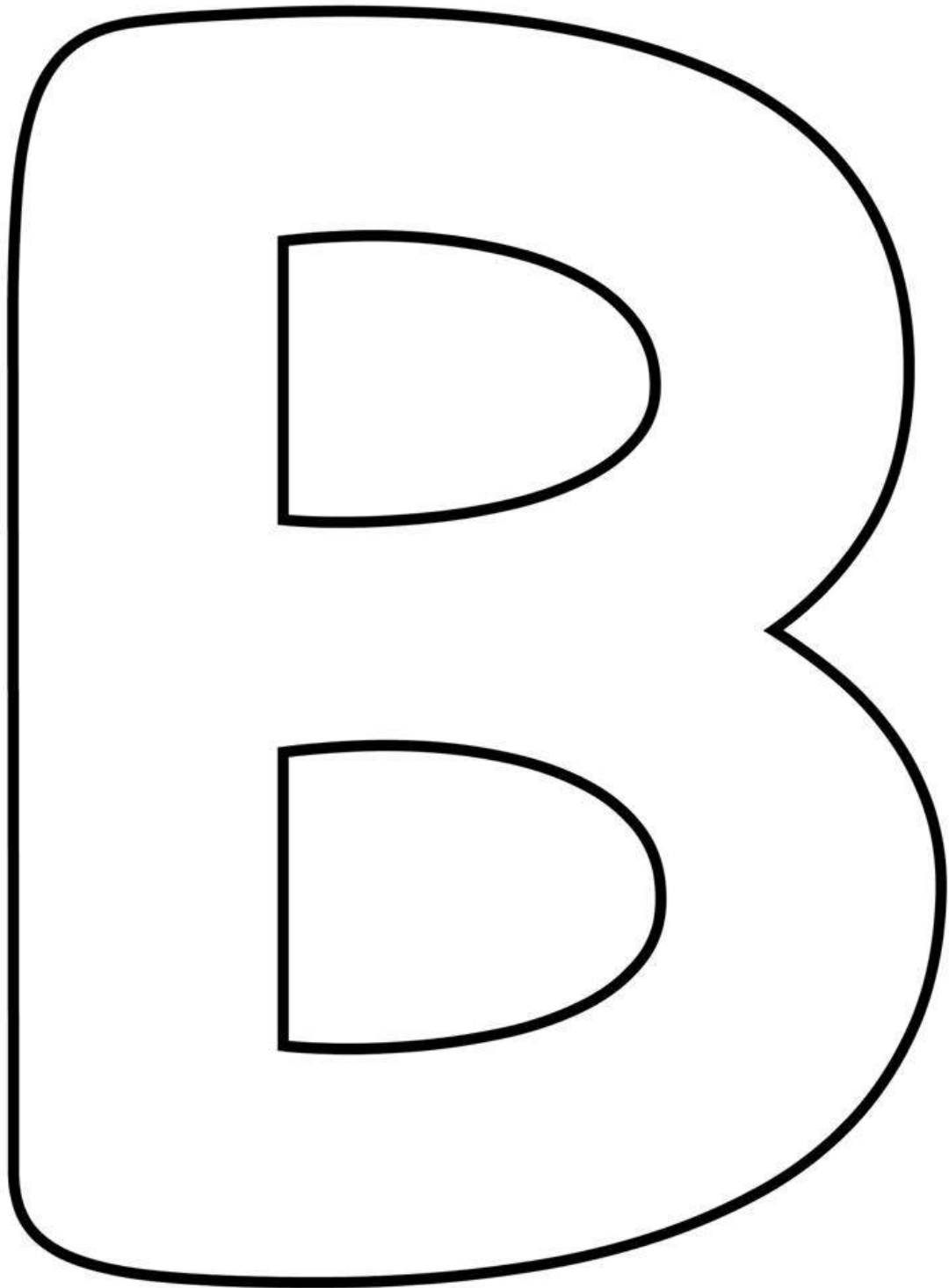

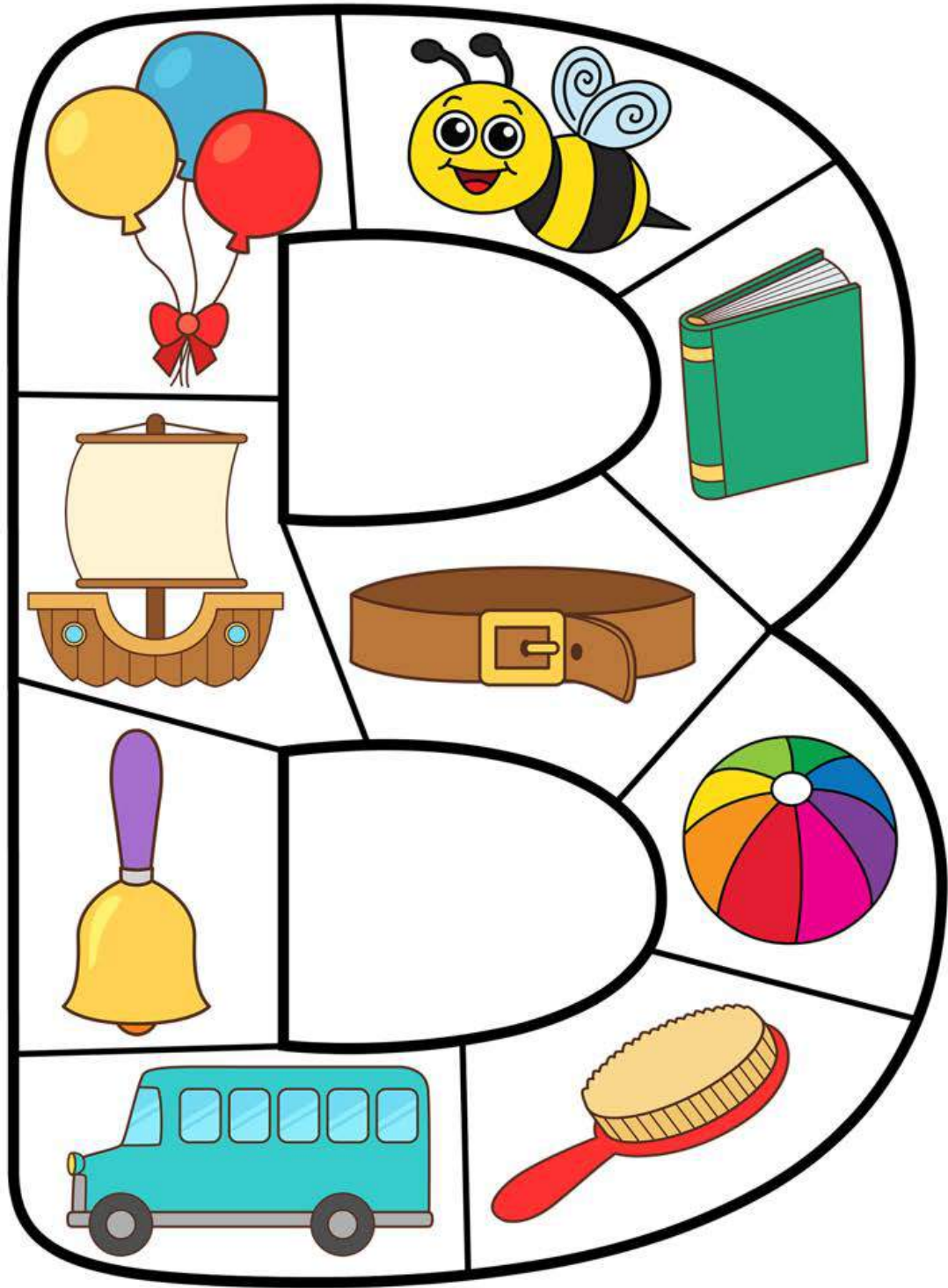

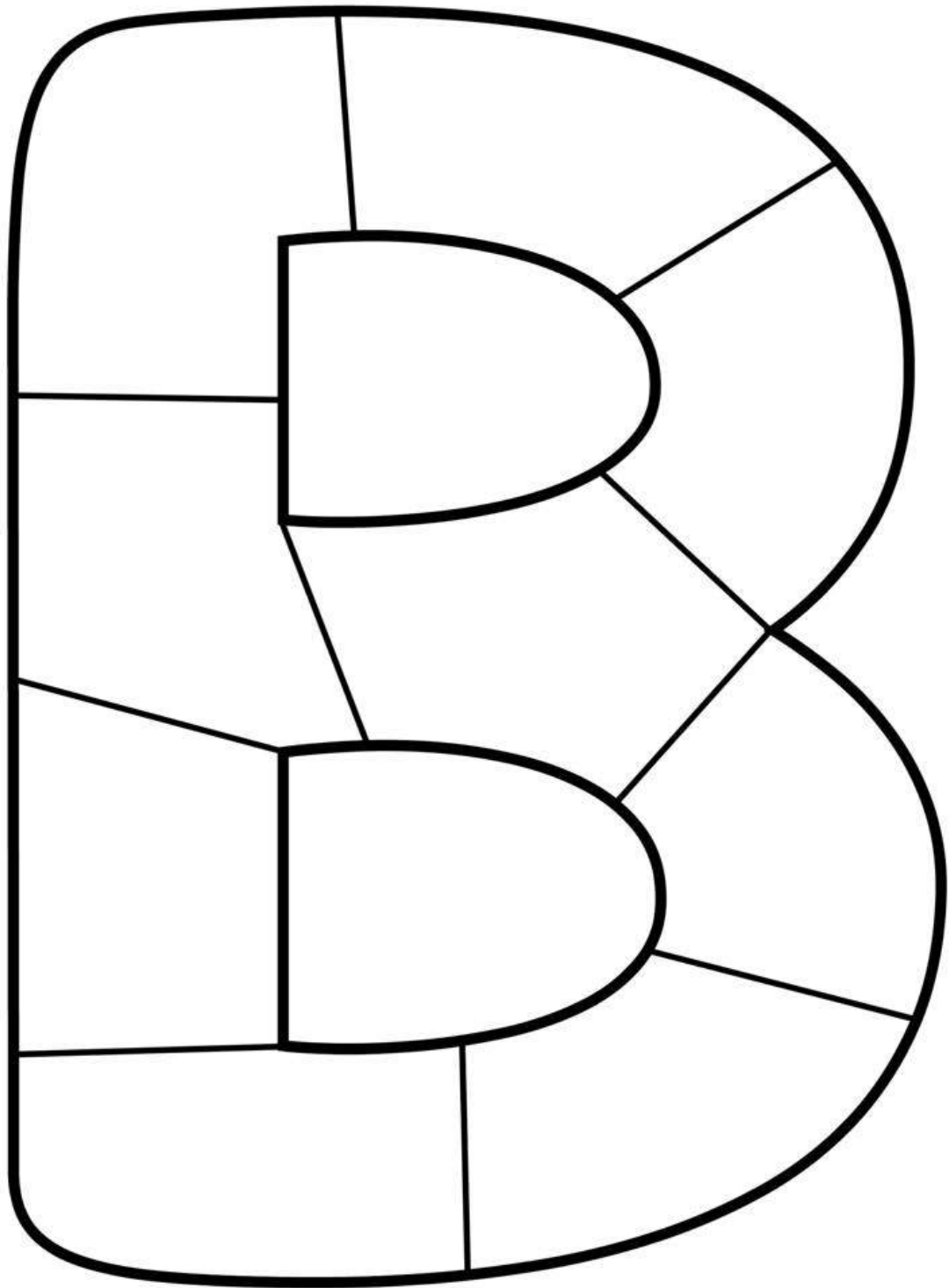

1. Write

2. Cut Out 

NAME : _____

B B

B B

b b

b b

B b

A B C Q U I L T

3. Color

4. Cut out 

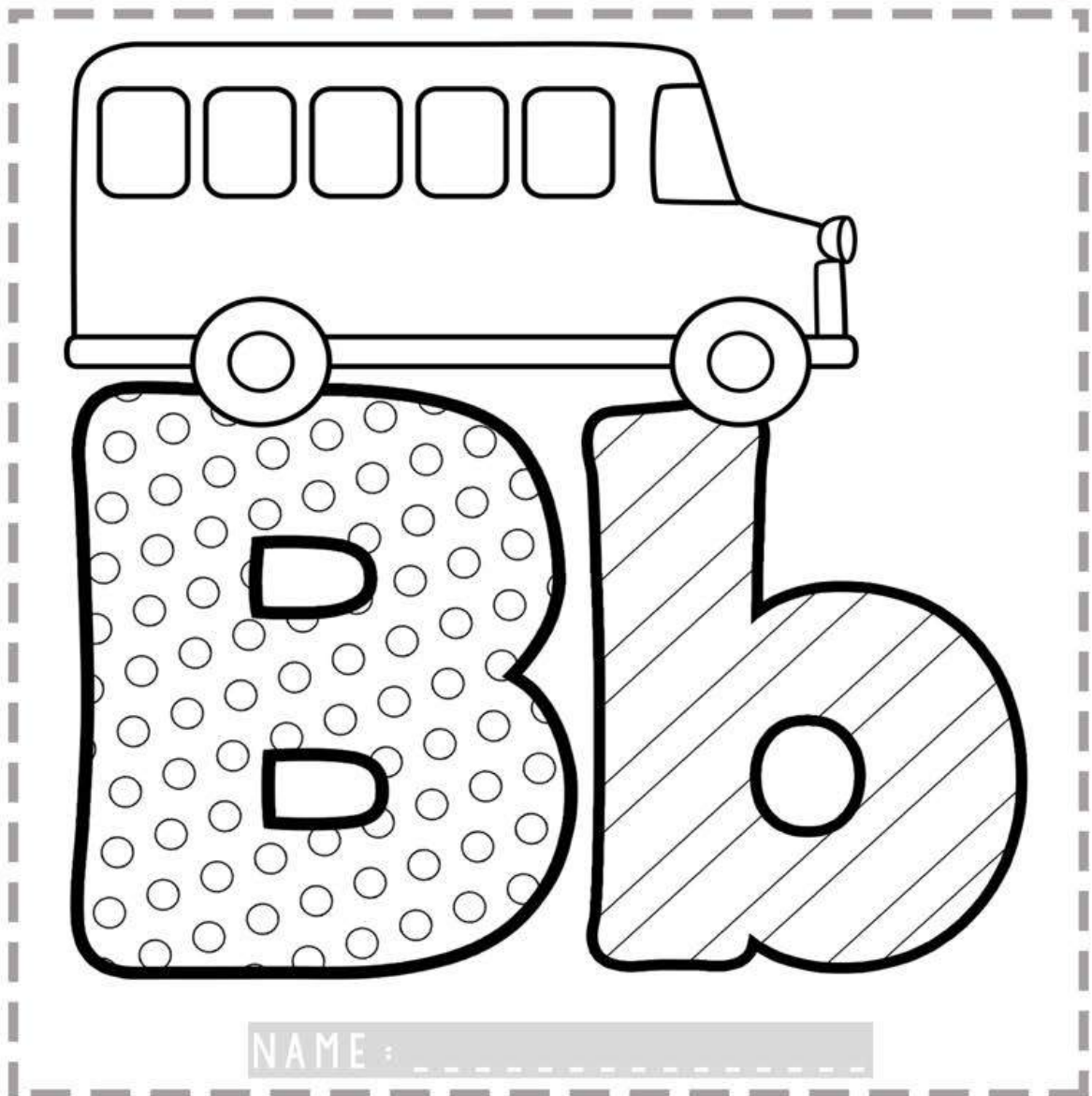

NAME : _____

Bb

Write and read words that begin with letter b.

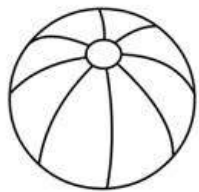

all all all



ee ee ee

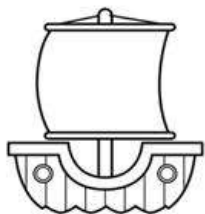

oat oat

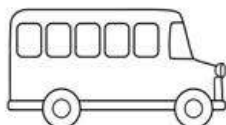

us us us

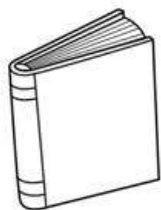

ook ook



rush rush



ear ear

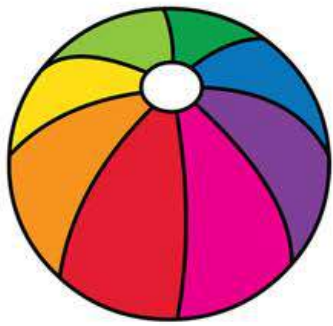

ball



balloons

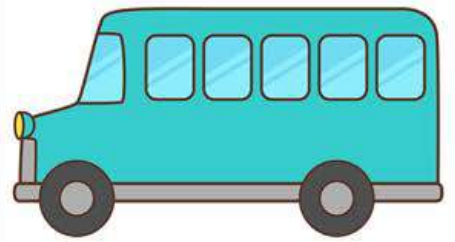

bus



bee



book

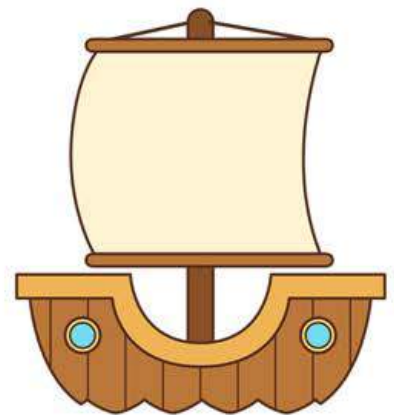

boat

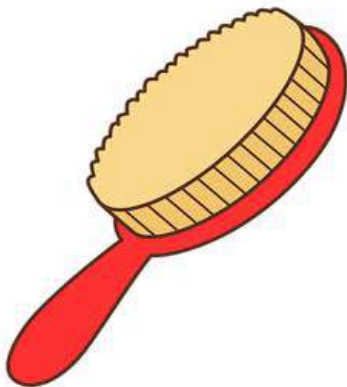

brush



bell





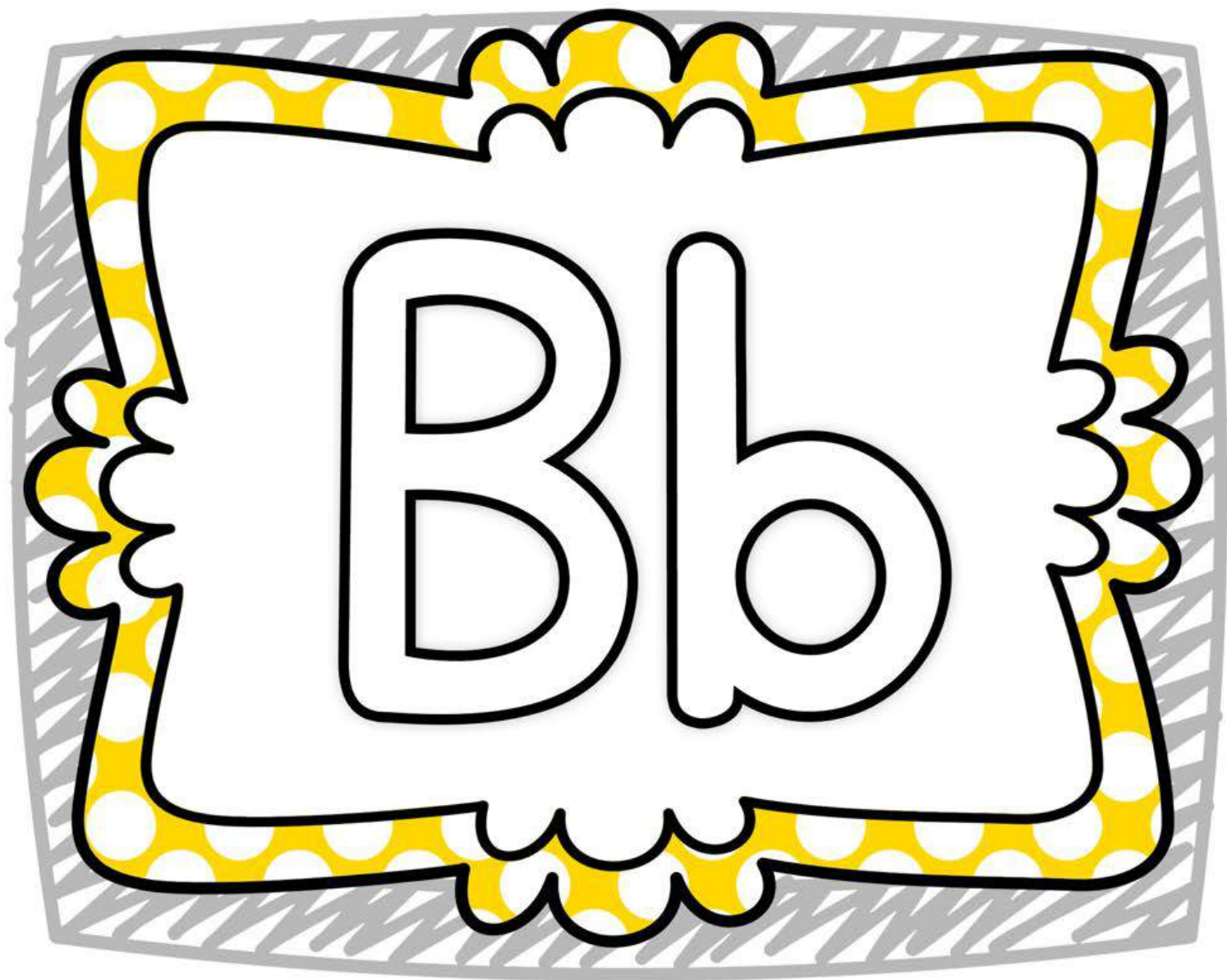













belt



LETTER B

















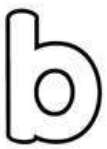

4 IN A ROW

LETTER B

















4 IN A ROW

LETTER B



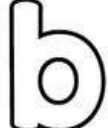













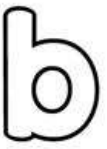

4 IN A ROW

LETTER B



4 IN A ROW

I C A N W R I T E

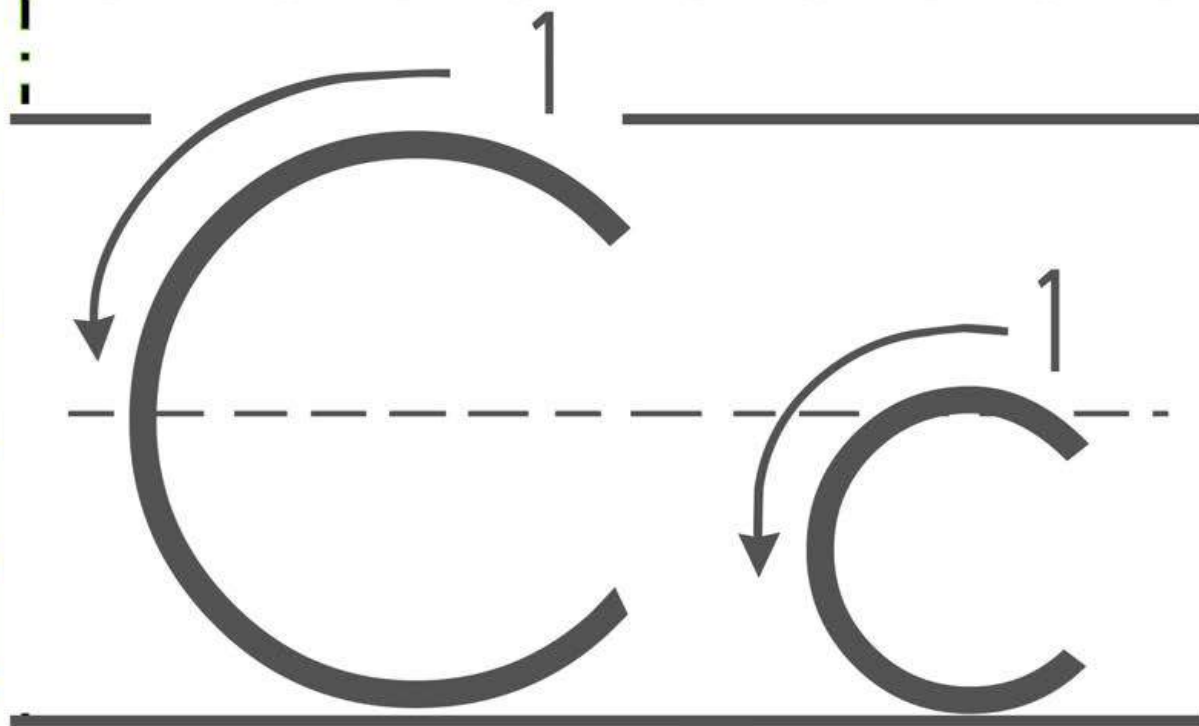

Circle Around

Circle Around

Cupcake



C c

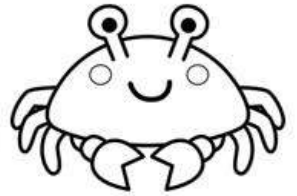
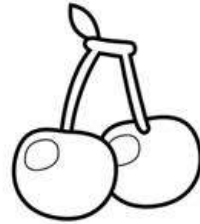
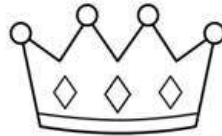
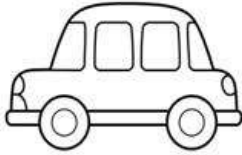
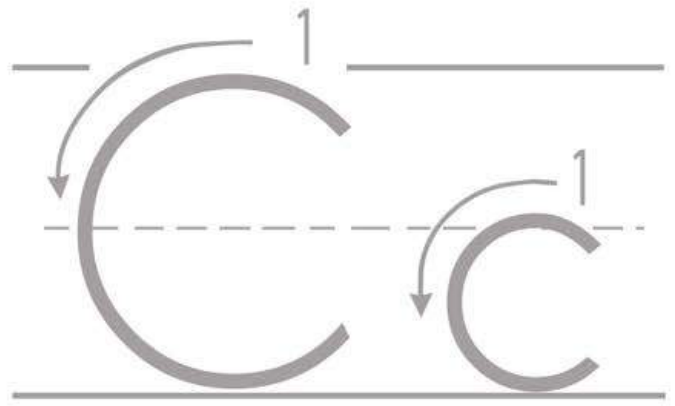

chair

car

cheese

crown

cherries

crab

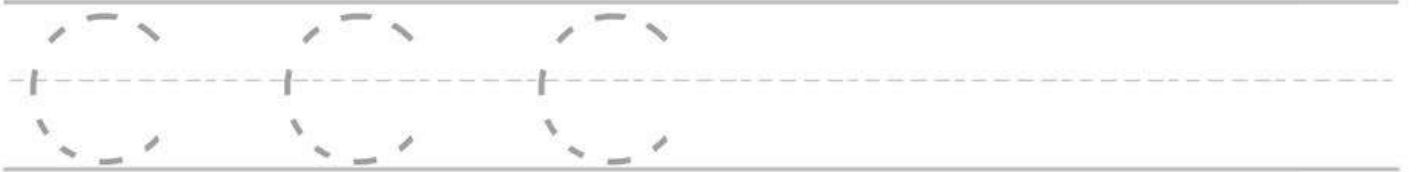
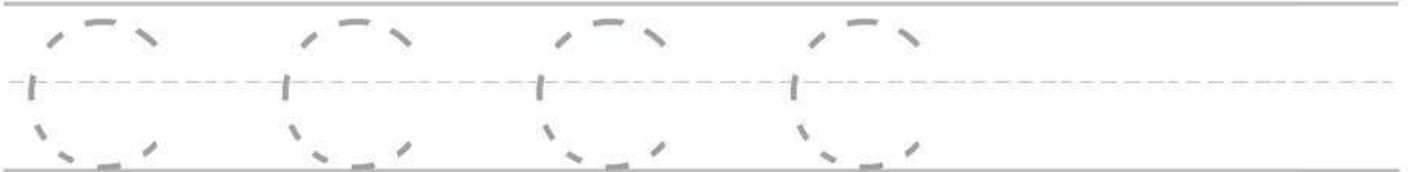
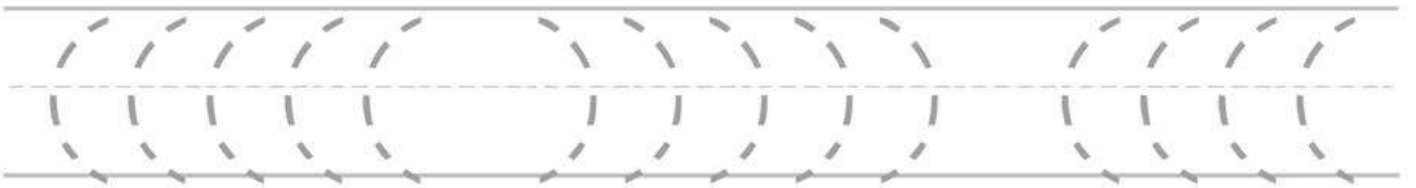

Color the circles red.

Color the diamonds green.

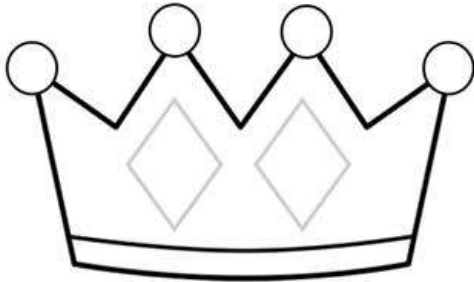

Measure:

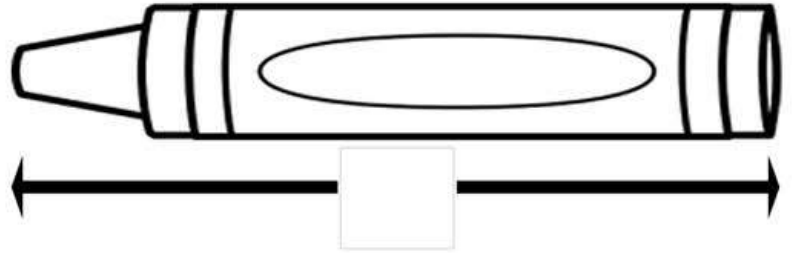
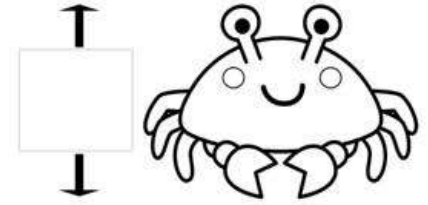

Add

$\square = \square$

Count & Tally

$3 + 1 = \square$

$3 + 2 = \square$

2	+	1	
3	+	3	\square

Circle what comes next:

Color the 4th candle. Put an X on the 10th candle.

Draw:

$2 + 3 = 5$

$+ =$

← \square — 2 — 3 — \square — 5 — 6 — \square →

C C

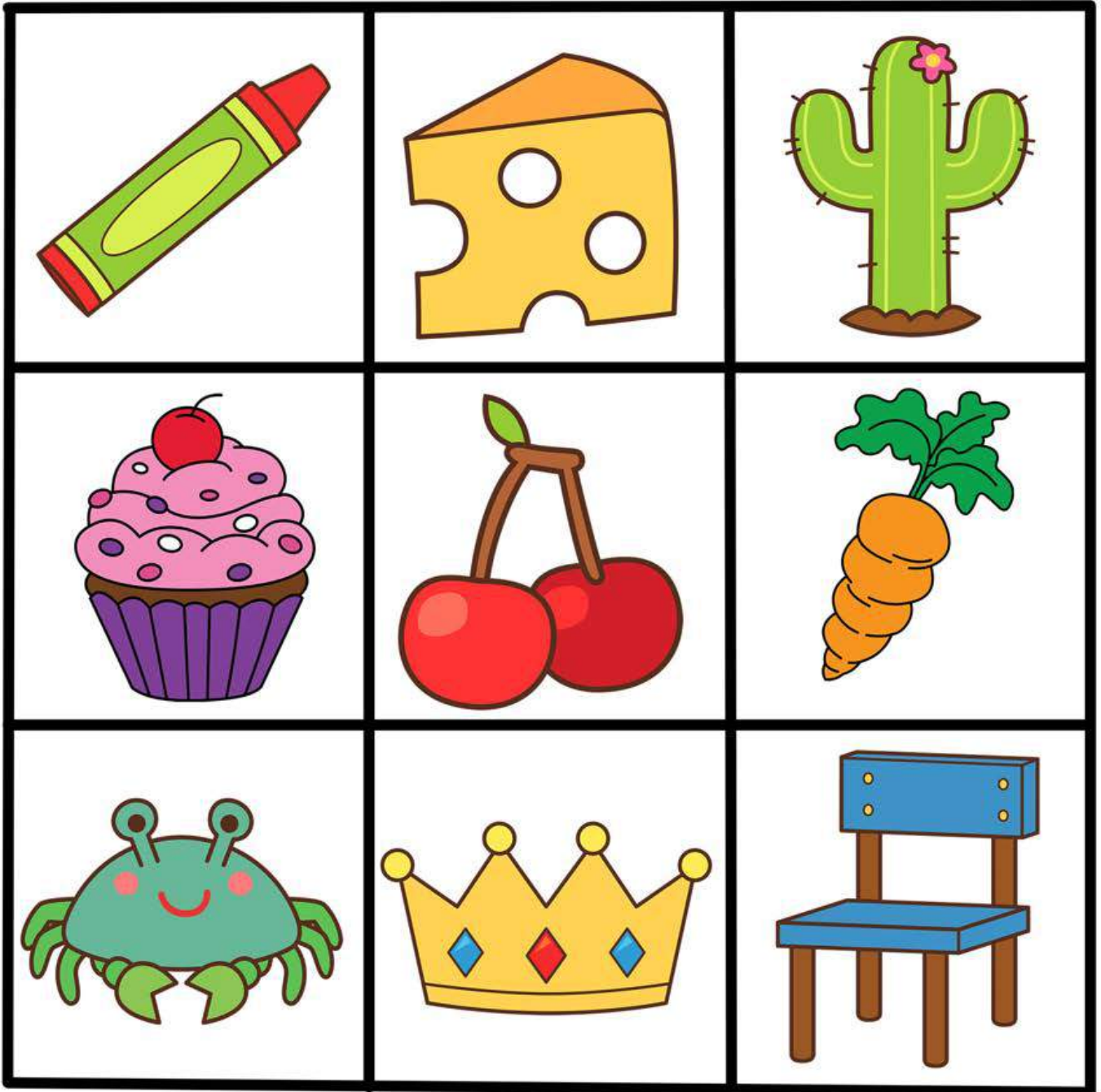
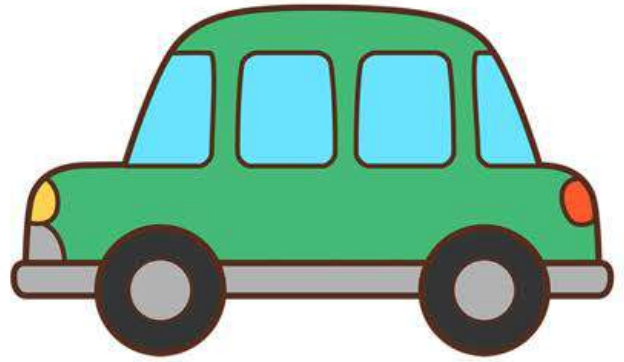

I CAN COLOR

 = cherries

 = crab

 = crown

 = crayon

 = car

 = cupcake

words with:

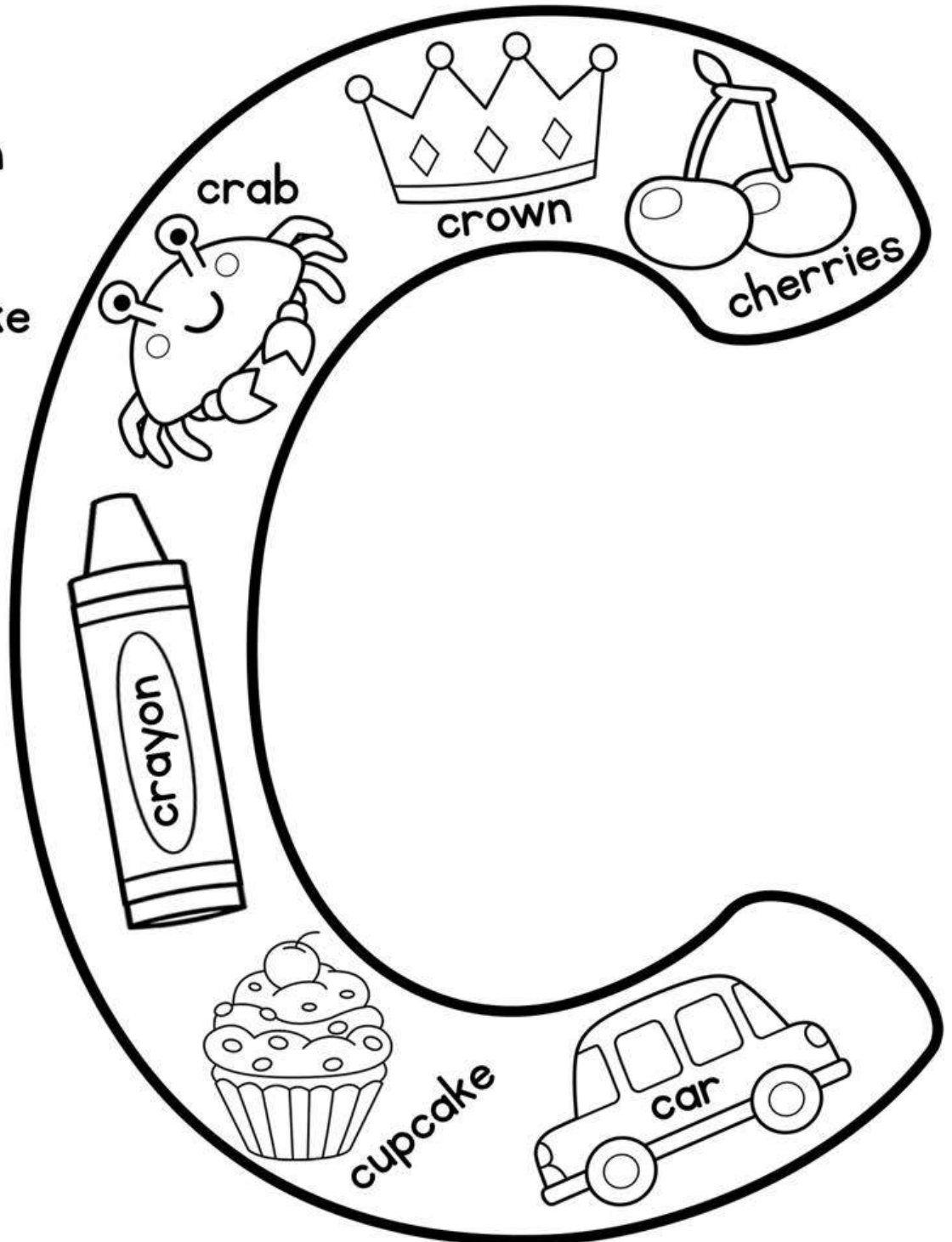

NAME : _____

Cc

Write and read words that begin with letter c.

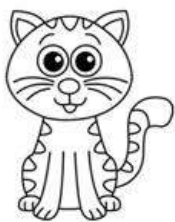

cat cat cat

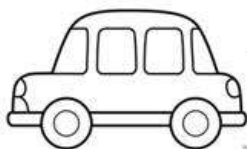

car car car



crab crab

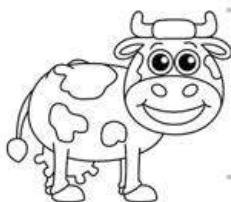

cow cow cow

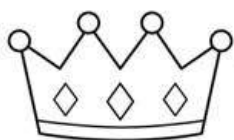

crown crown



candy candy



cheese

NAME : _____

Cc

Write and read words that begin with letter c.

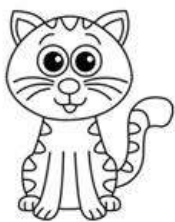

cat cat cat

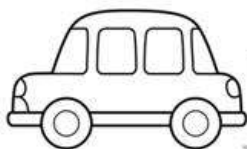

car car car



crab crab

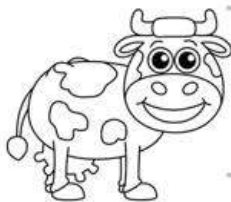

cow cow

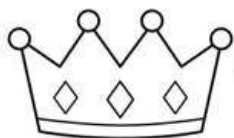

crown crown

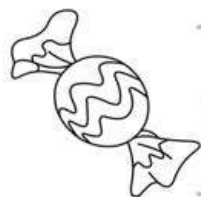

candy candy



cheese

NAME : _____

RACE TO THE TOP

Use a paperclip and a pencil to complete the spinner.

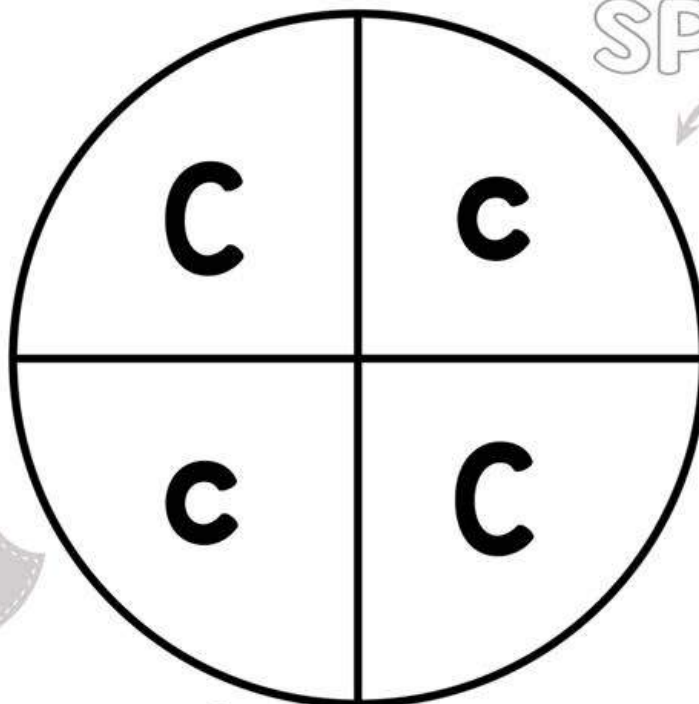

SPIN



Record

Report:

How many spins landed on C?

How many spins landed on c?

Which had more?

Write an inequality: >

How many spins total?

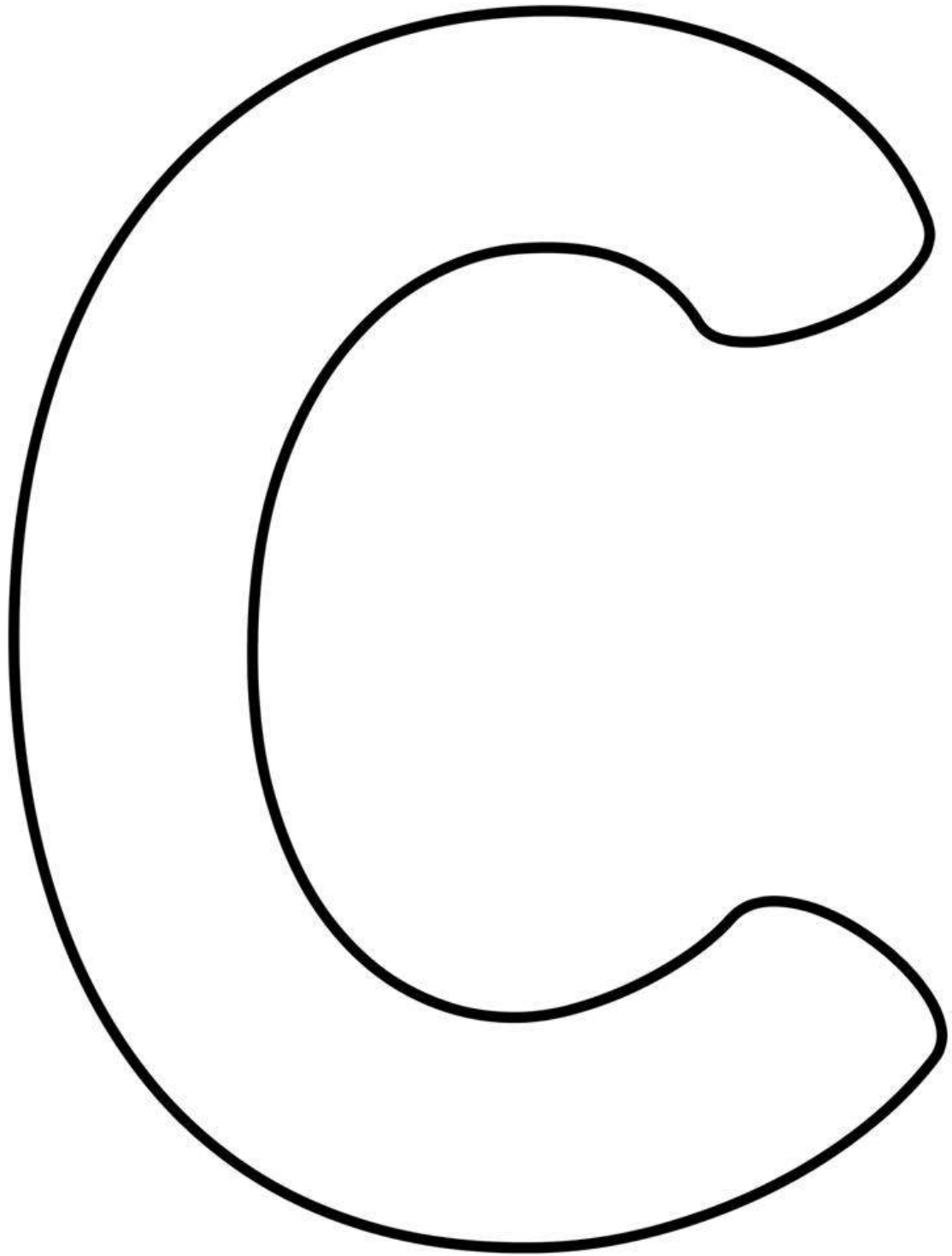

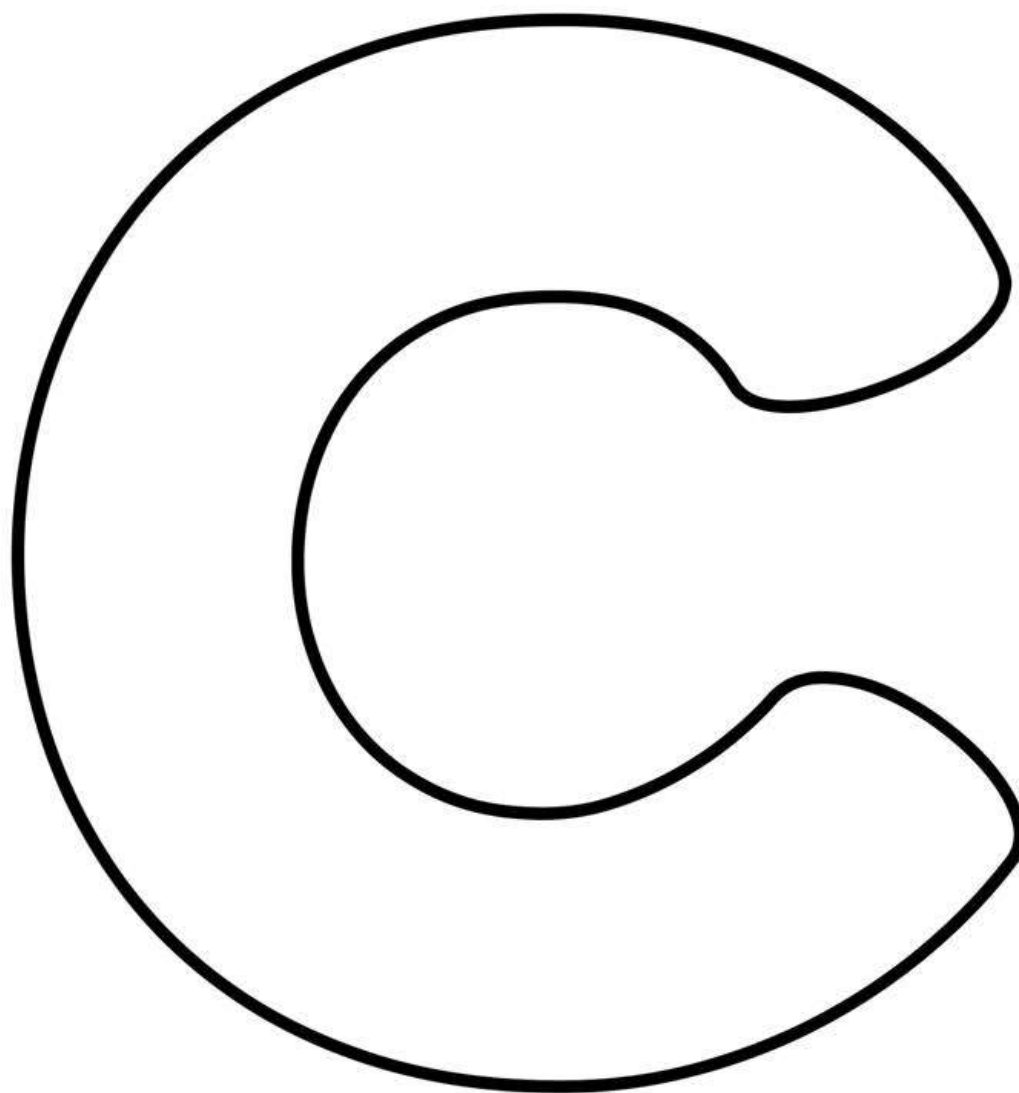

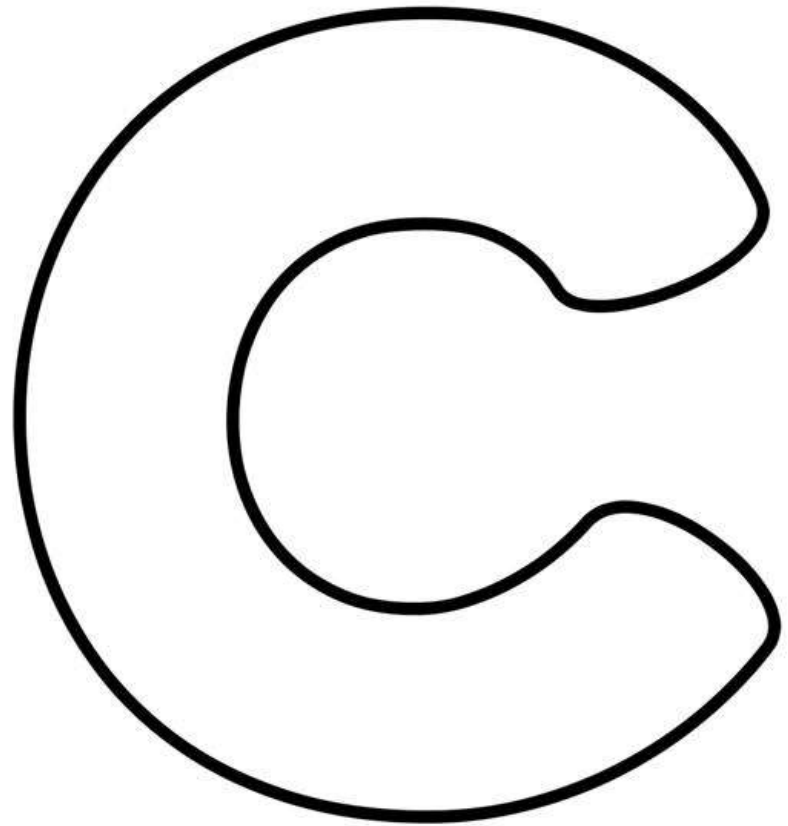
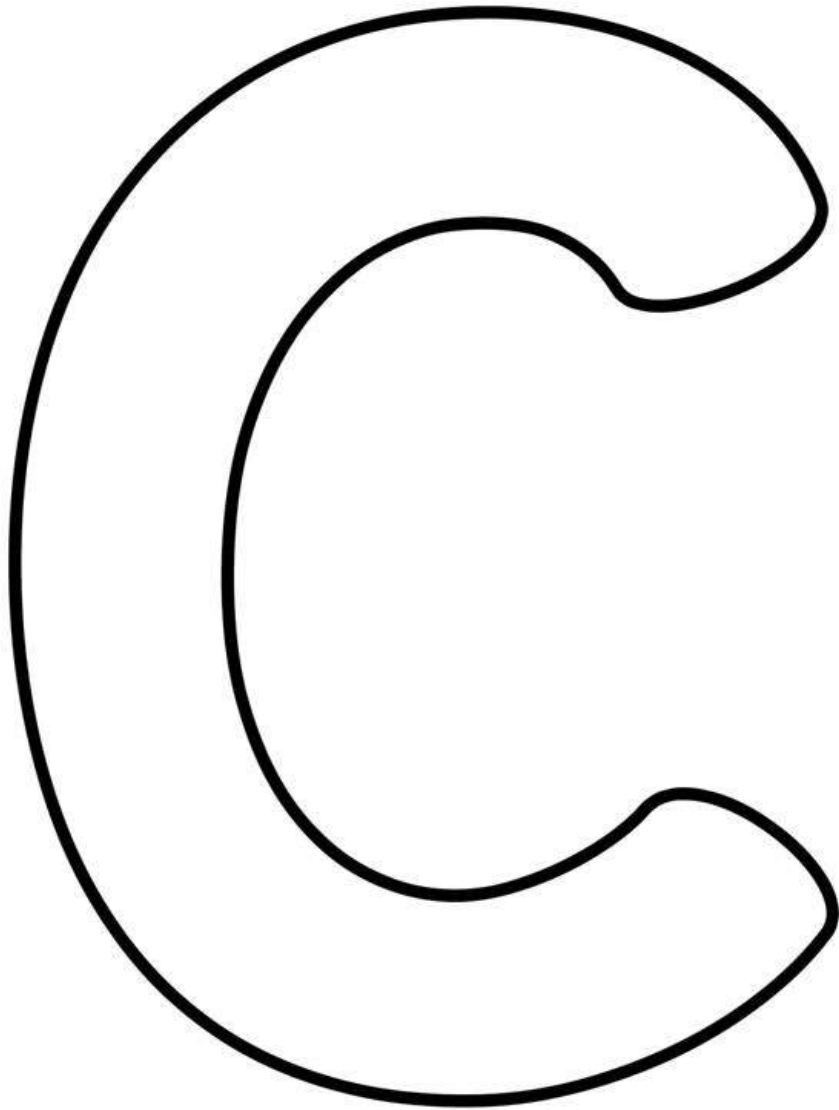

I C A N

F I N D

the letter:

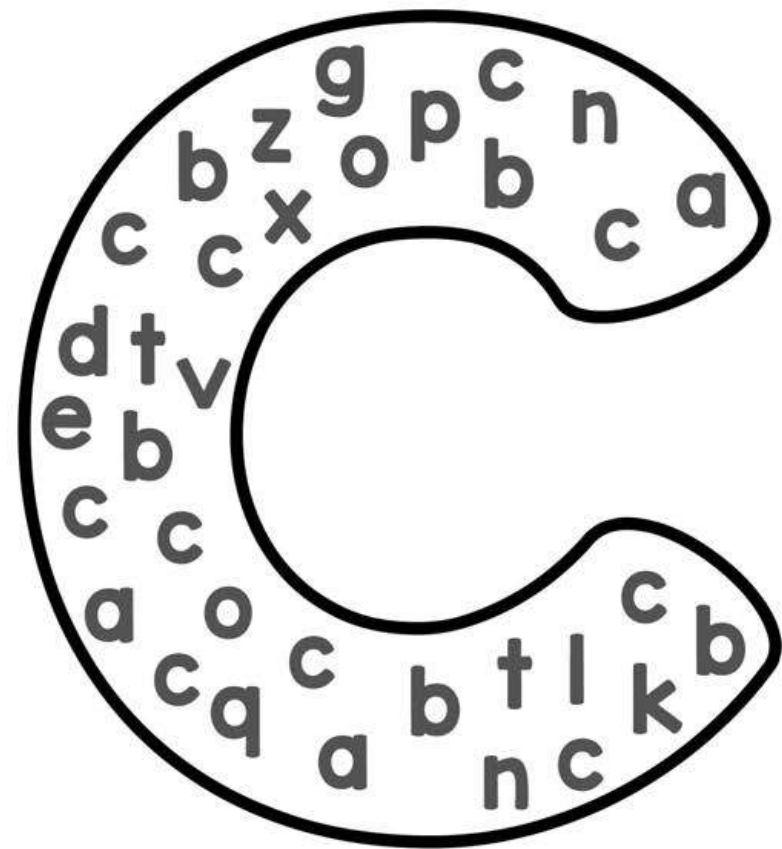
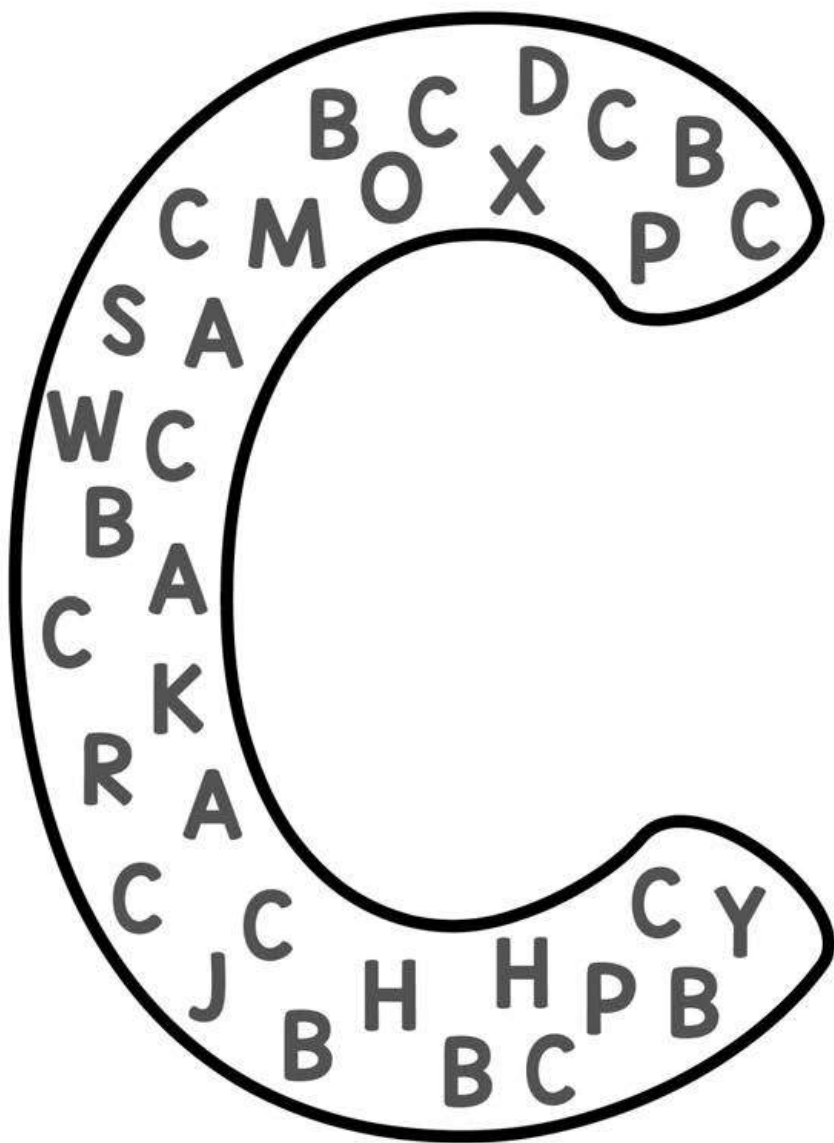

How Many?

How Many?

TRACE

NAME : _____





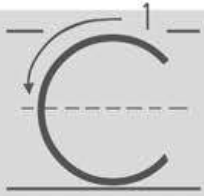

Color one for each row of letters you complete

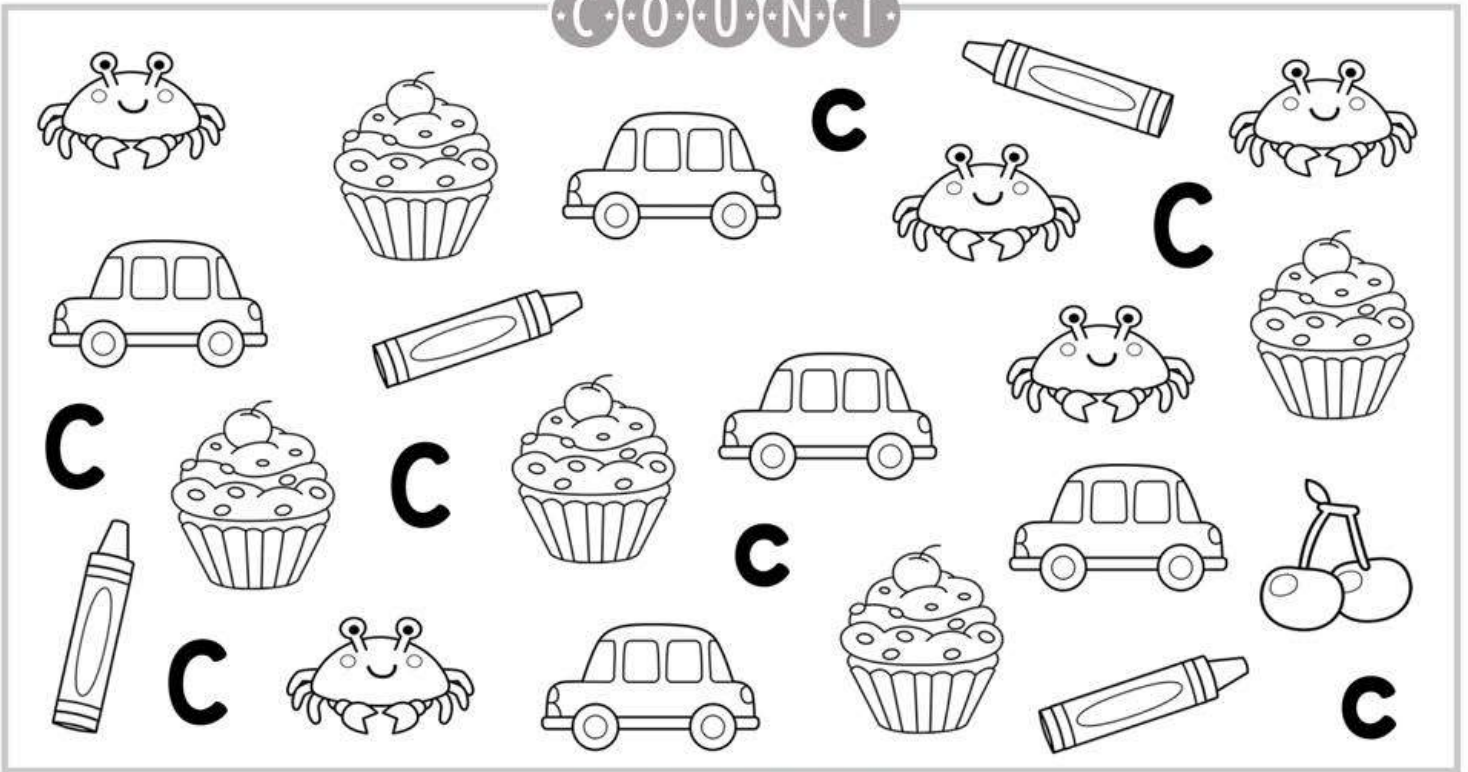

C · O · U · N · T ·



G · R · A · P · H ·

C	c					

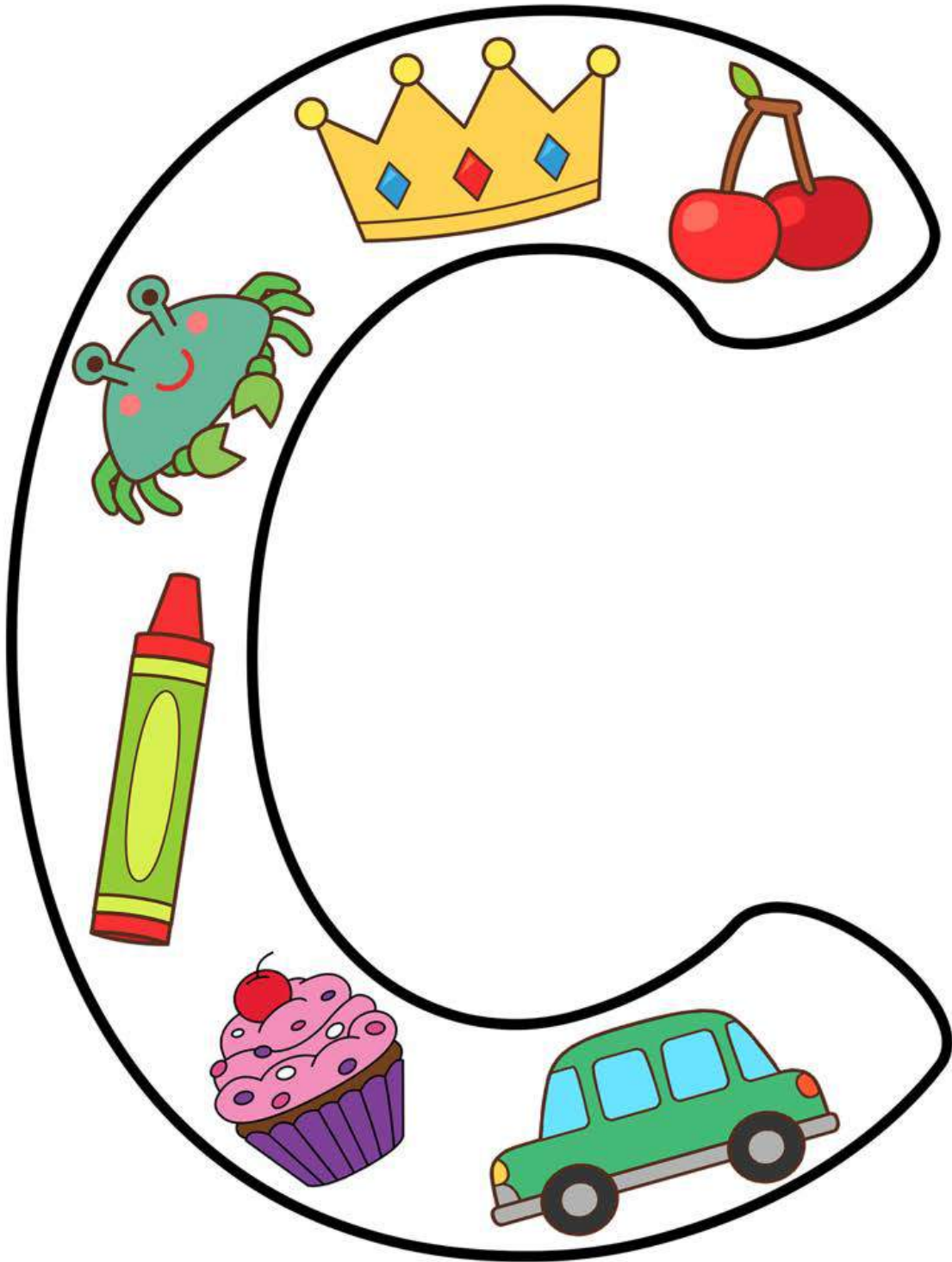

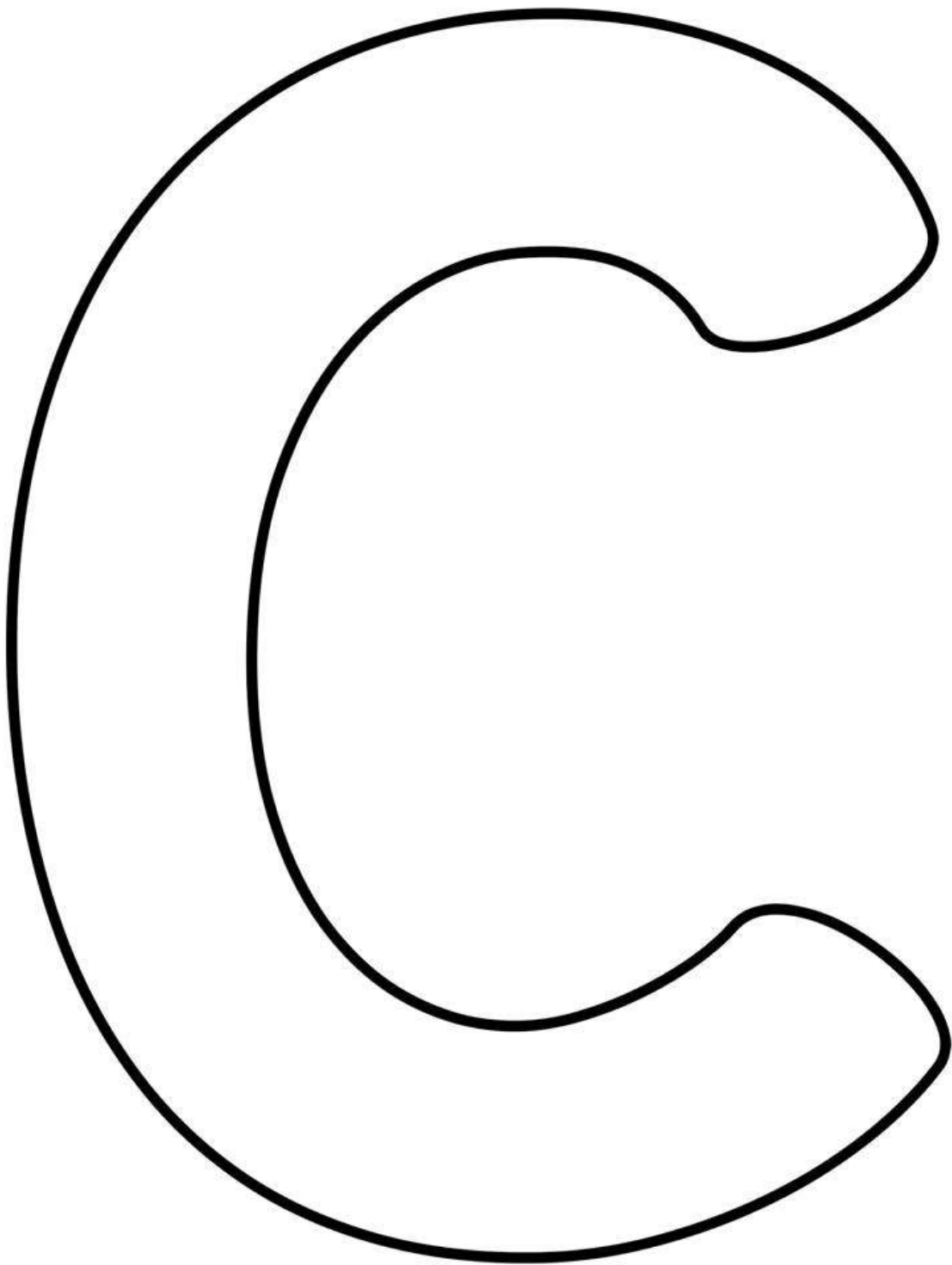

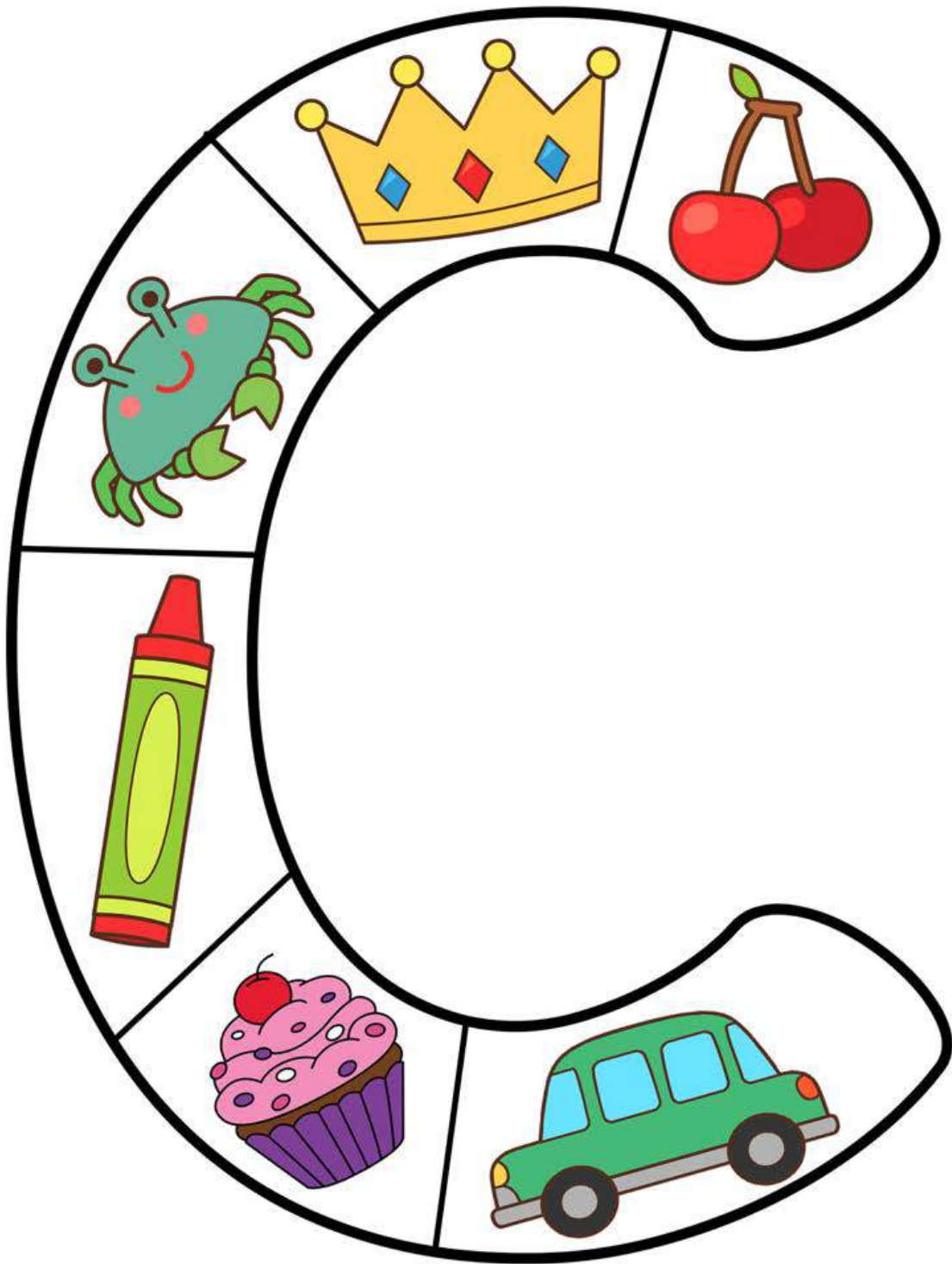

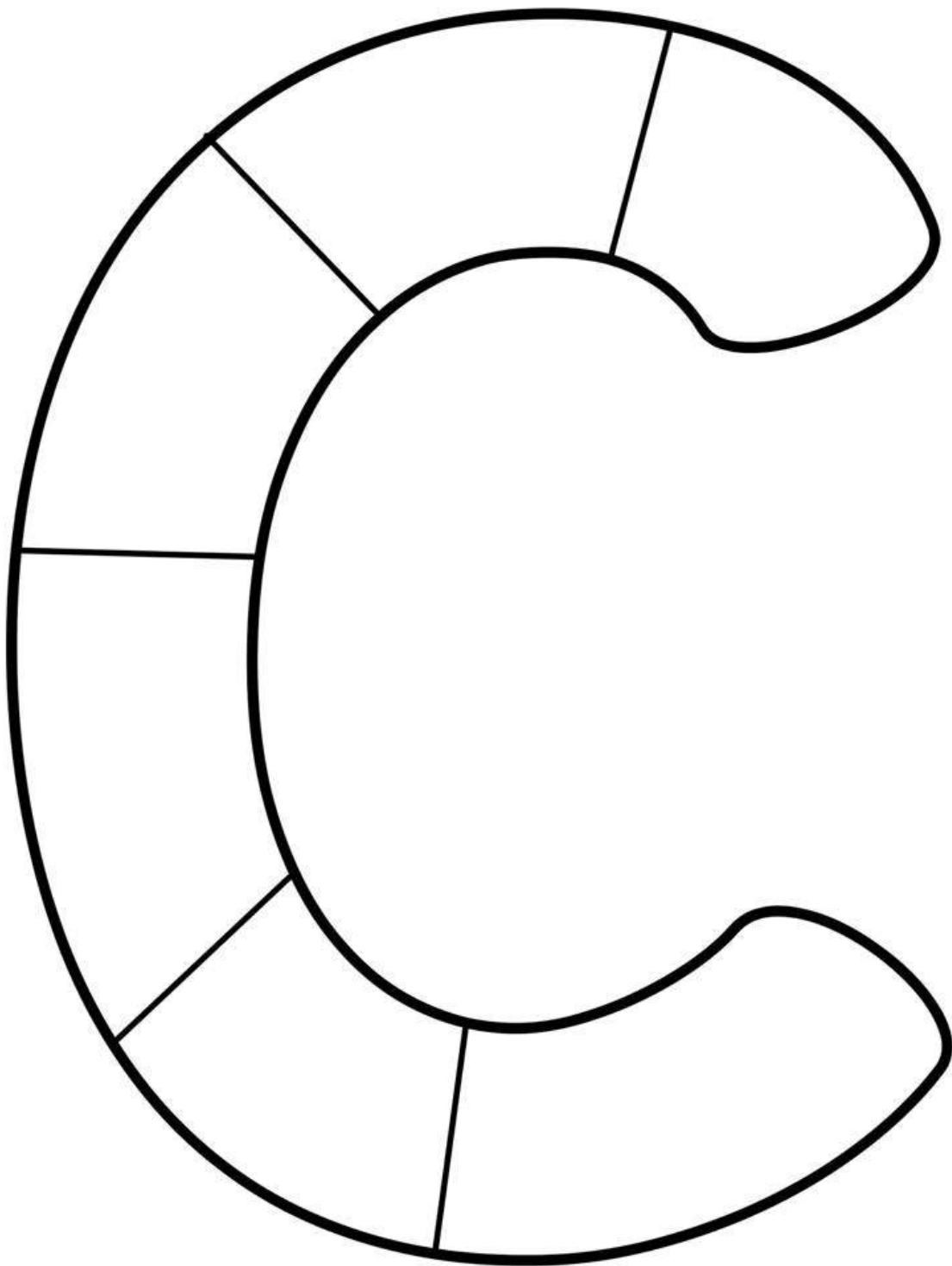

1. Write

2. Cut Out 

A B C Q U I L T

3. Color

4. Cut out 

NAME : _____

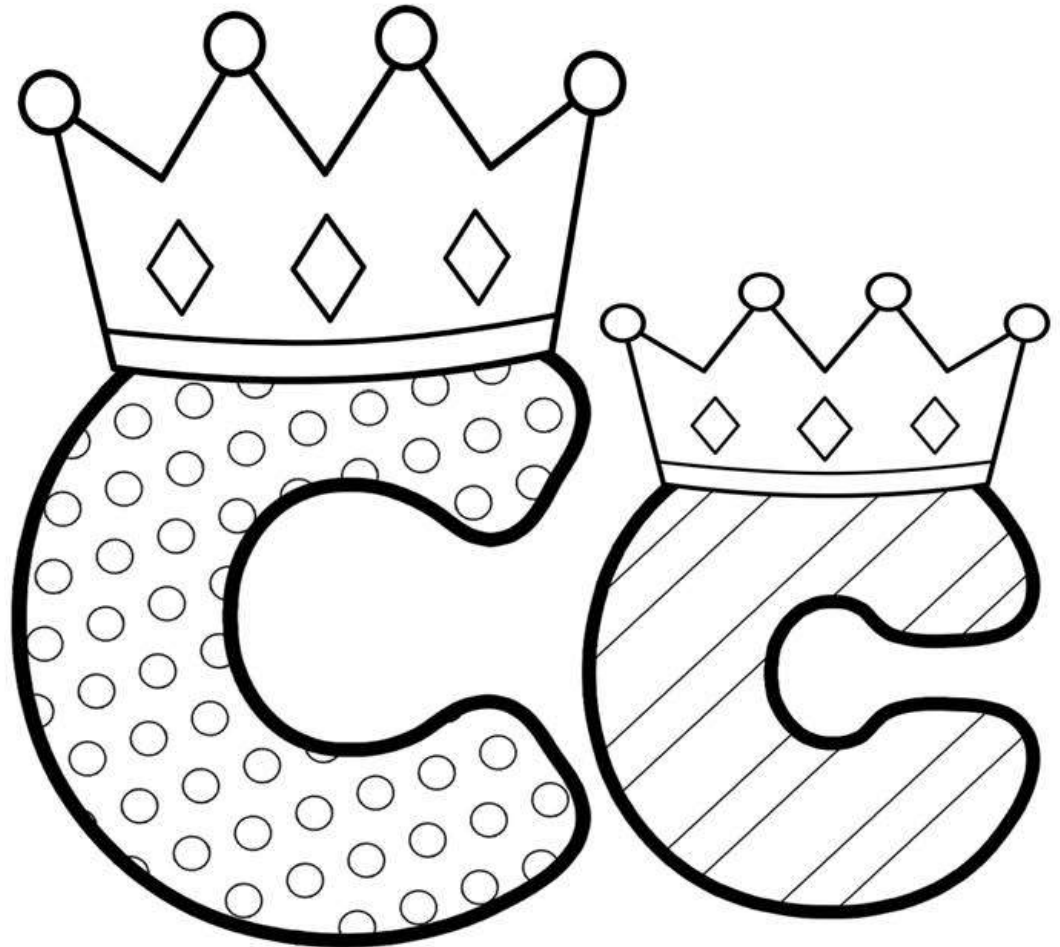
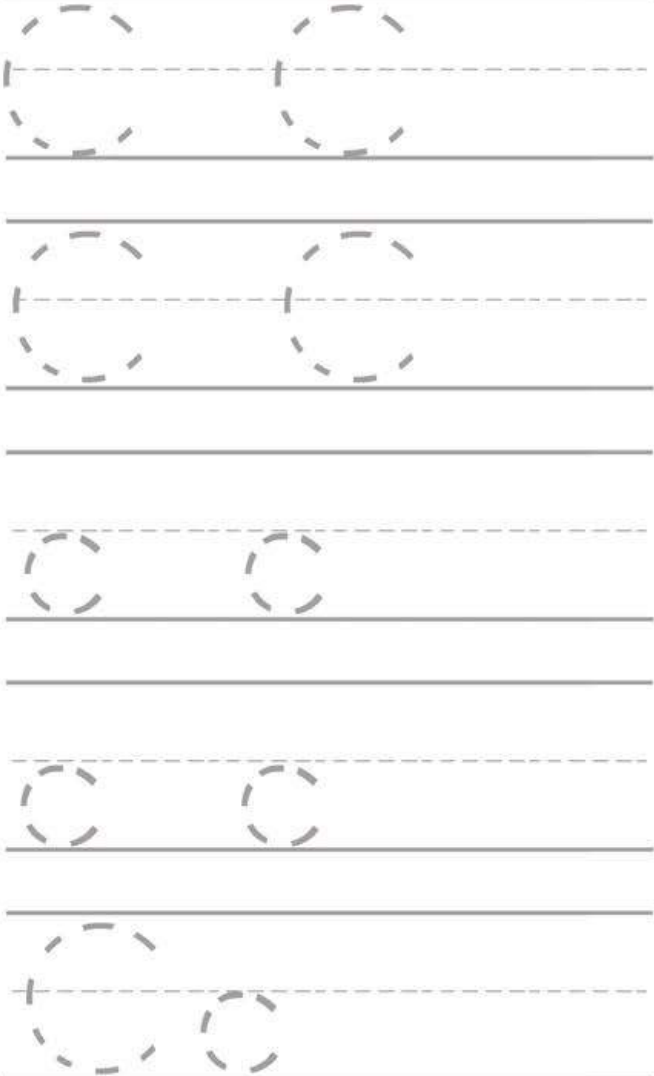

NAME : _____

NAME : _____

Cc

Write and read words that begin with letter c.

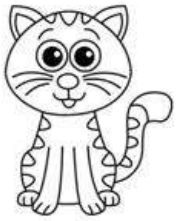

at at at

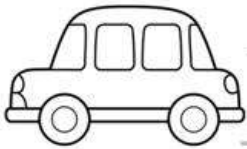

ar ar ar

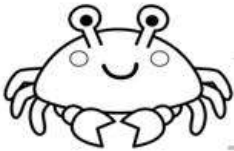

rab rab

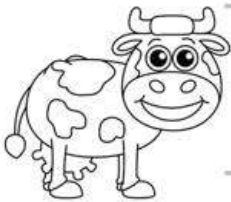

ow ow ow

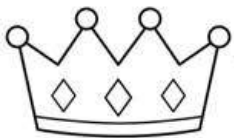

rown rown



andy andy



heese

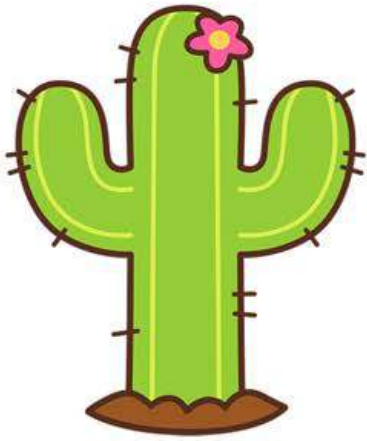

cactus



crown



chair

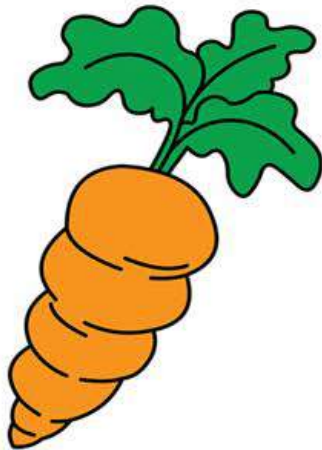

carrot

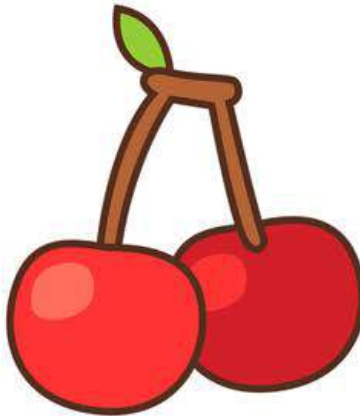

cherries

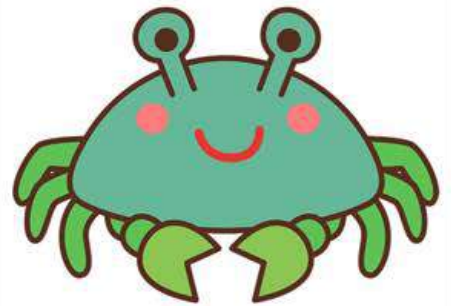

crab



cupcake

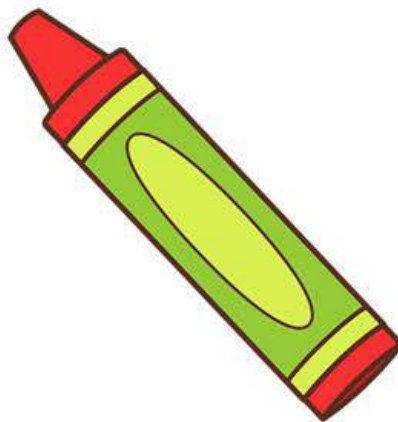

crayon

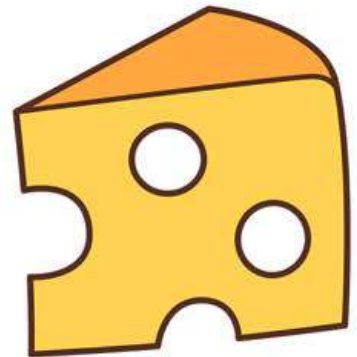



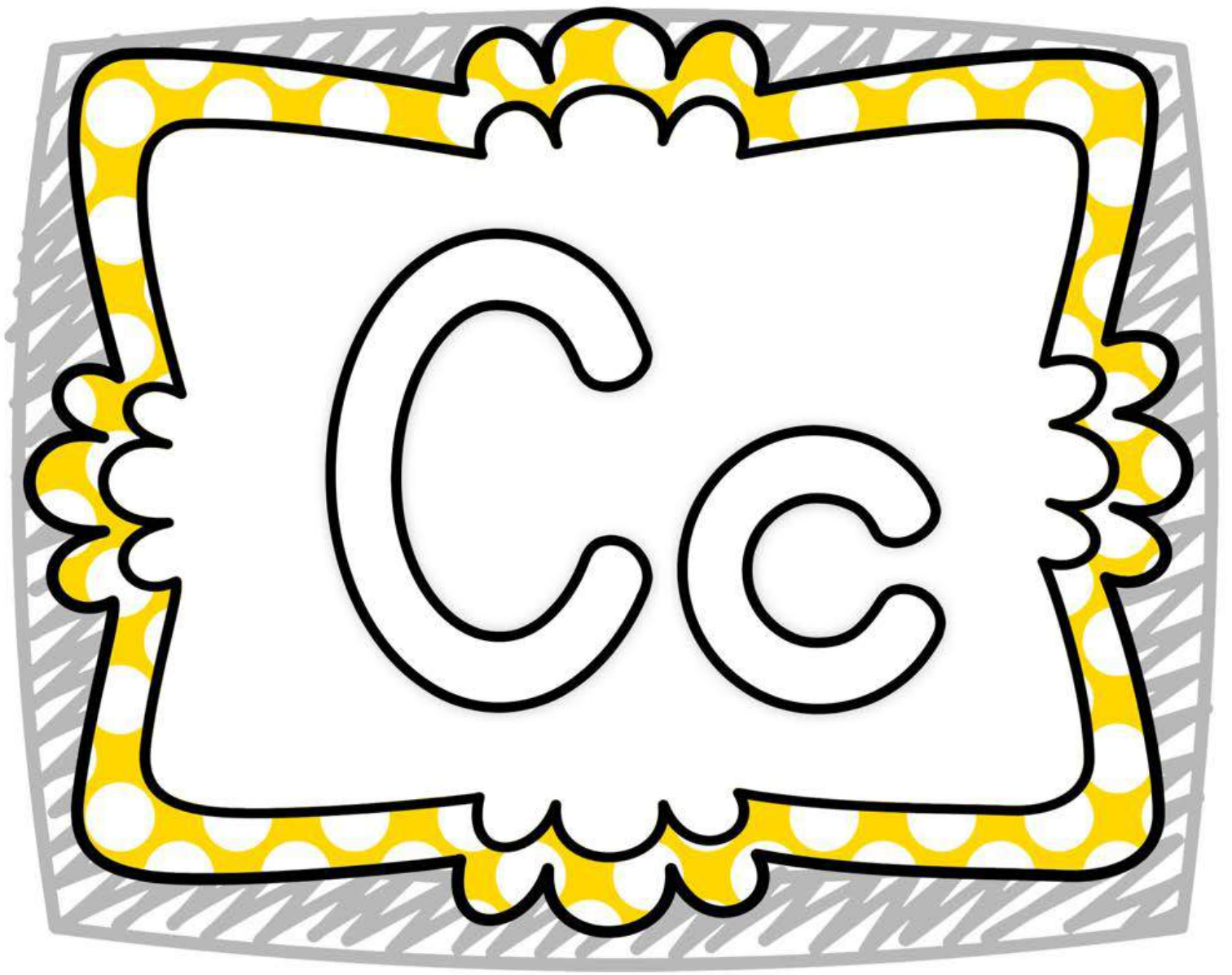













cheese



LETTER C



















4 IN A ROW

LETTER C



















4 IN A ROW

LETTER C













4 IN A ROW

LETTER C

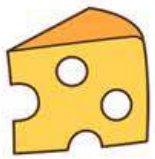

4 IN A ROW

I CAN WRITE

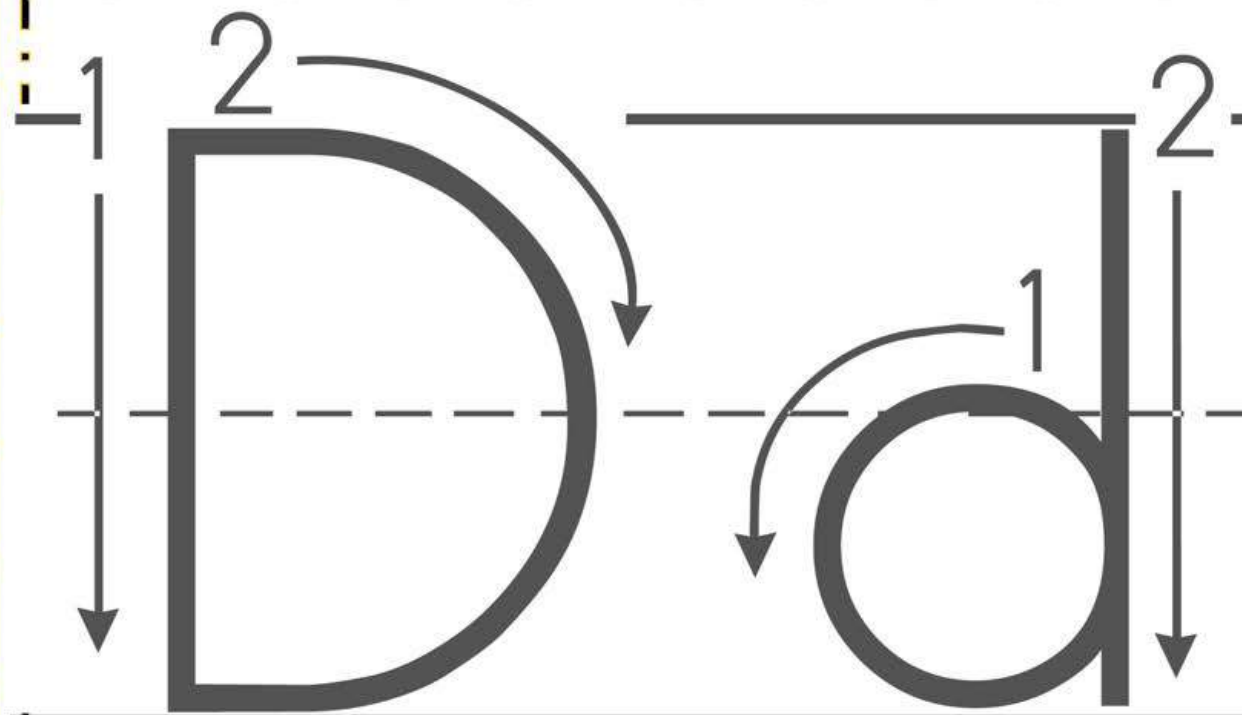

Line Down

Pick up

Big Belly Jump

Circle Around

Pick up

Then Down

Dinosaur

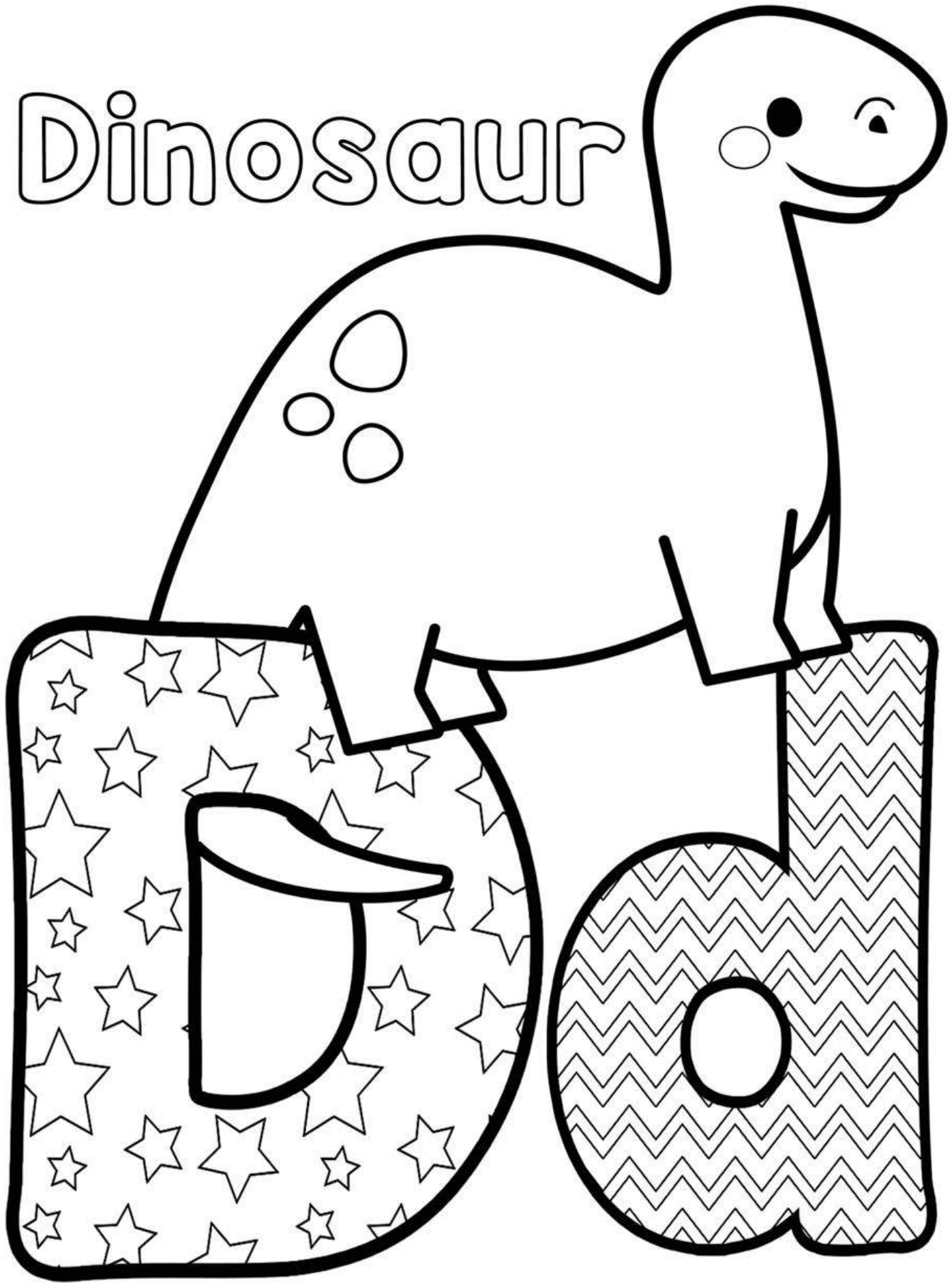

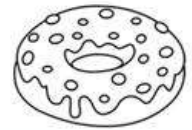
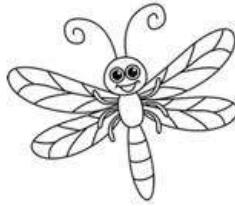
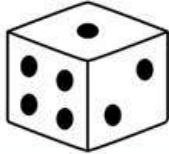
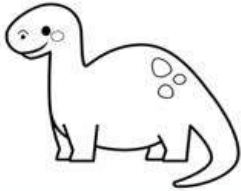
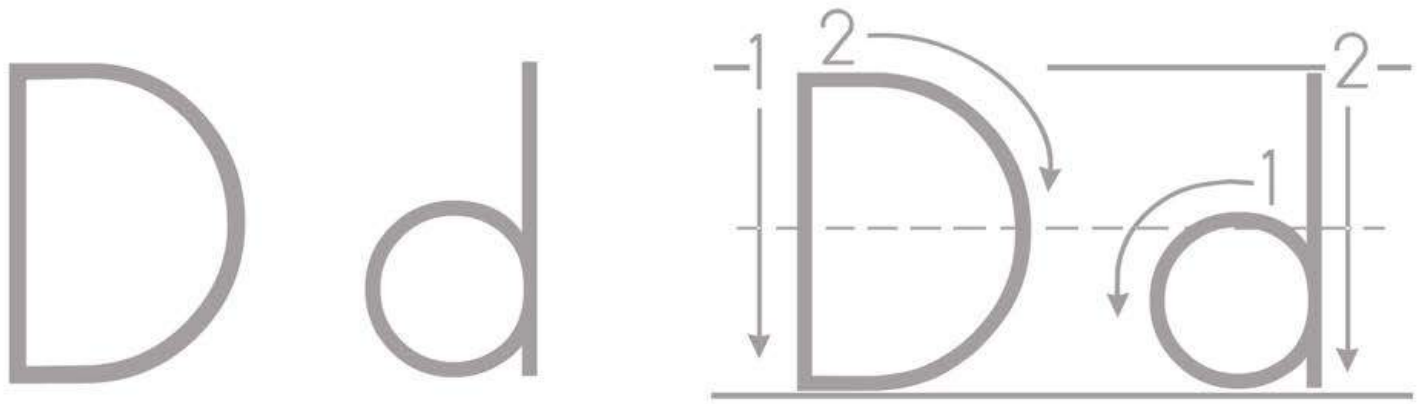

doll

dinosaur

die

dragonfly

dress

doughnut

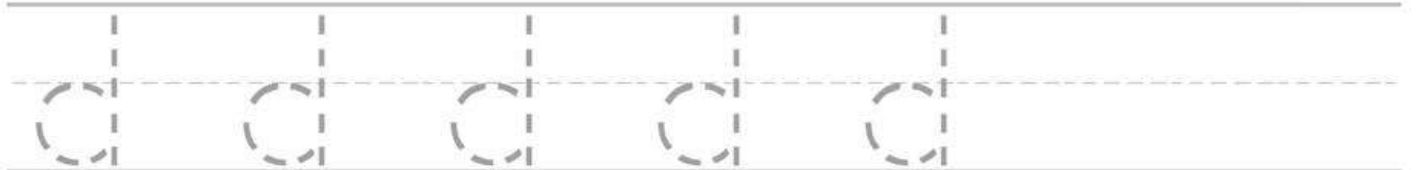
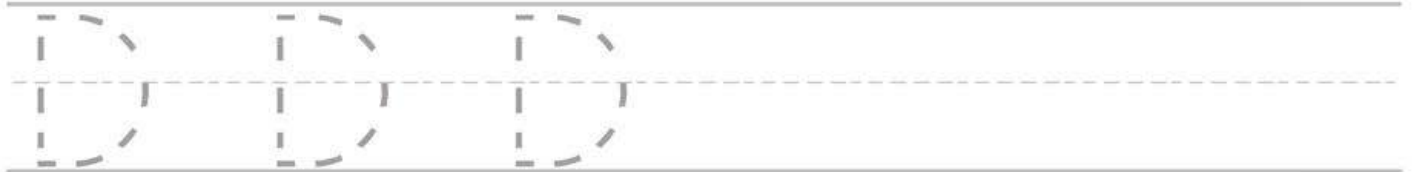
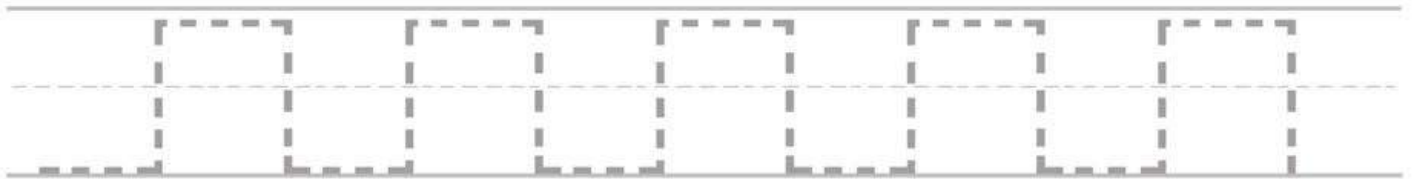

copy 

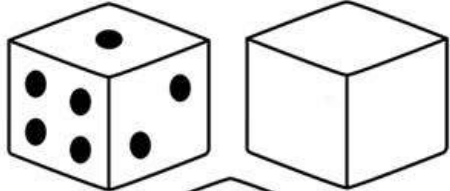

Mix it up 

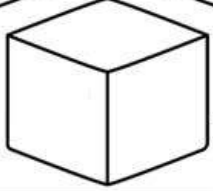

Measure each side of the diamond:

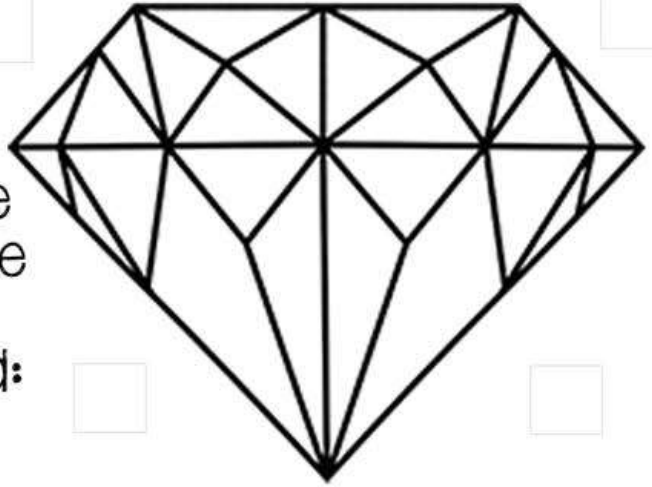

Add

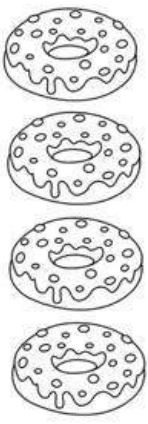

+

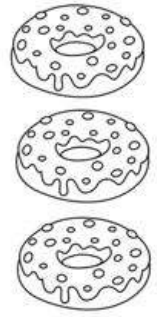



=



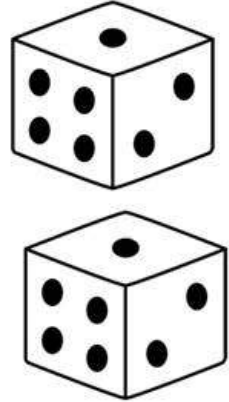

Count & Tally



$4 + 1 =$ 

$1 + 4 =$ 

$\begin{array}{r} 2 \\ + 4 \\ \hline \end{array}$ 

$\begin{array}{r} 4 \\ + 2 \\ \hline \end{array}$ 

Circle what comes next:



Write a D on the 3rd and 5th dish. X the 2nd dish.



Draw: $4 + 4 = 8$

$\quad + \quad =$

Dd

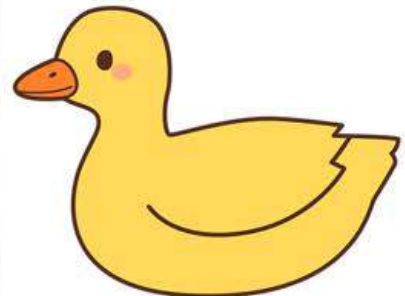
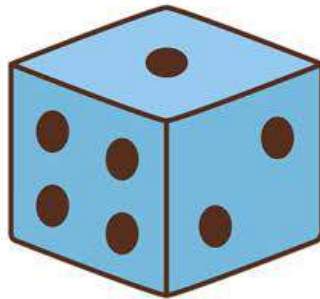
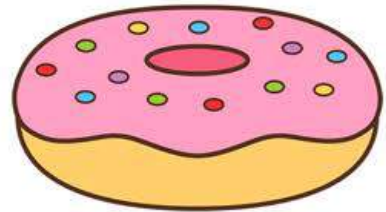
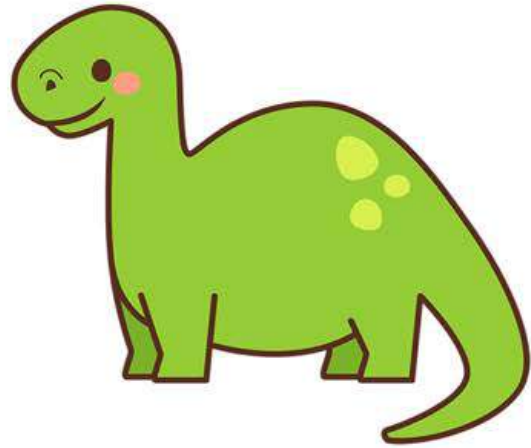

I CAN COLOR

words with:

 = dress

 = drum

 = die

 = dinosaur

 = doll

 = dragonfly

 = doughnut

 = door

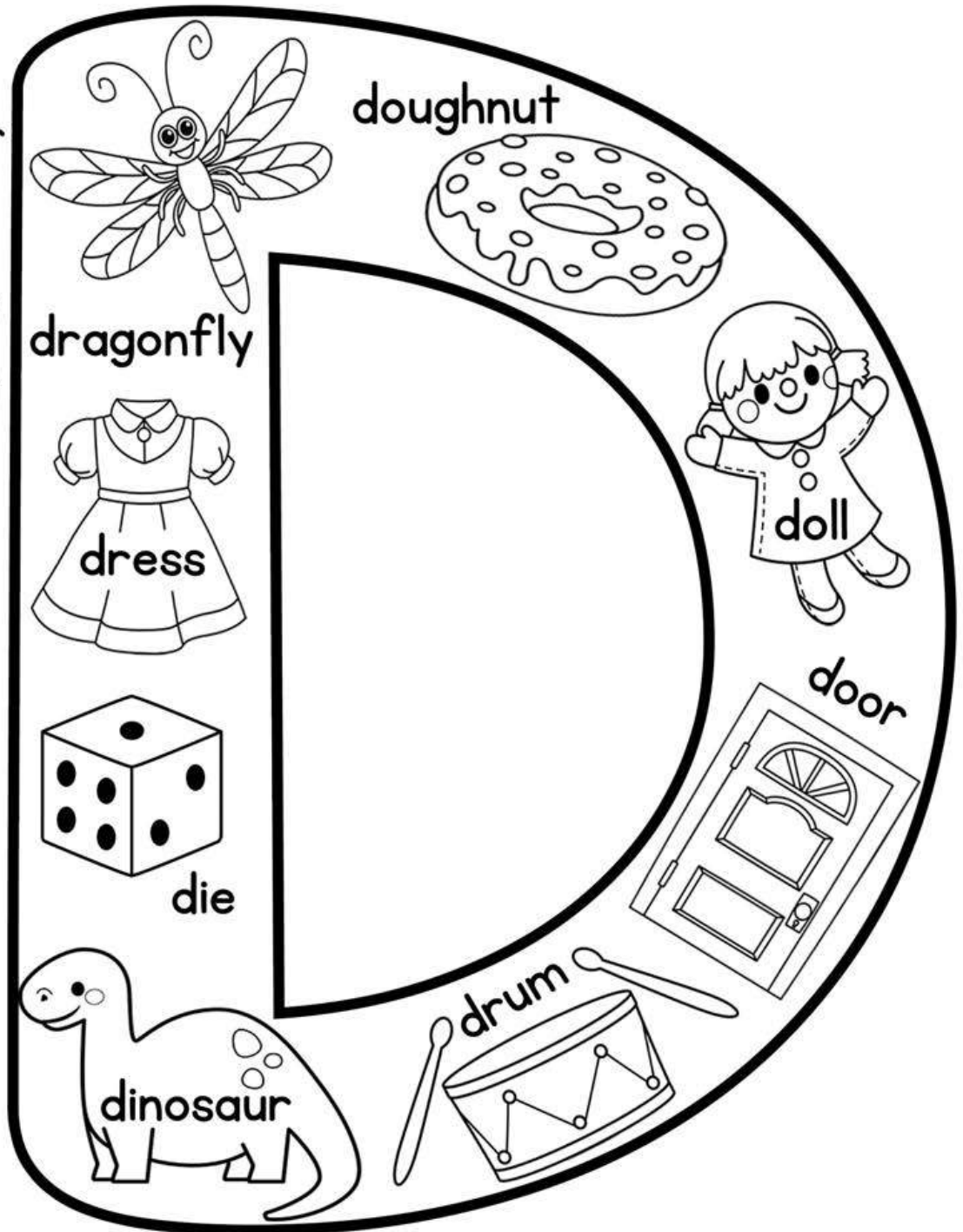

NAME : _____

Dd

Write and read words that begin with letter d.



duck duck

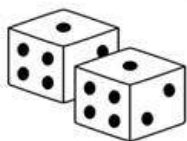

dice dice



drum drum



door door



dish dish dish



desk desk



dinosaur

NAME : _____

Dd

Write and read words that begin with letter d.



Duck Duck

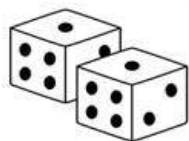

Dice Dice



Drum Drum



Door Door



Dish Dish



Desk Desk



Dinosaur

NAME : _____

RACE TO THE TOP

Use a paperclip and a pencil to complete the spinner.

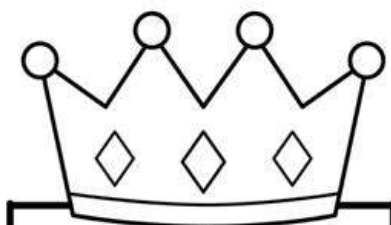

D	d
D	d
D	d
D	d
D	d
D	d
D	d
D	d
D	d
D	d
D	d

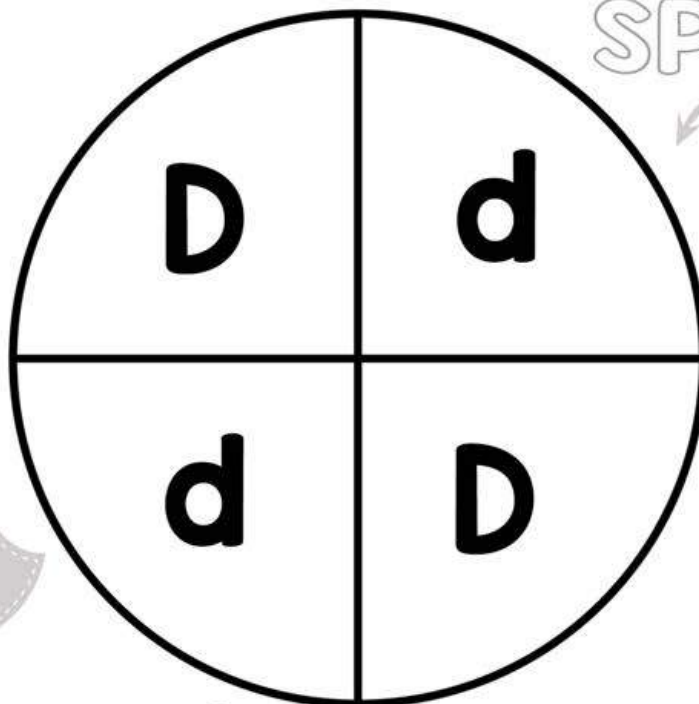

SPIN



Record

Report:

How many spins landed on D?

How many spins landed on d?

Which had more?

Write an inequality: >

How many spins total?

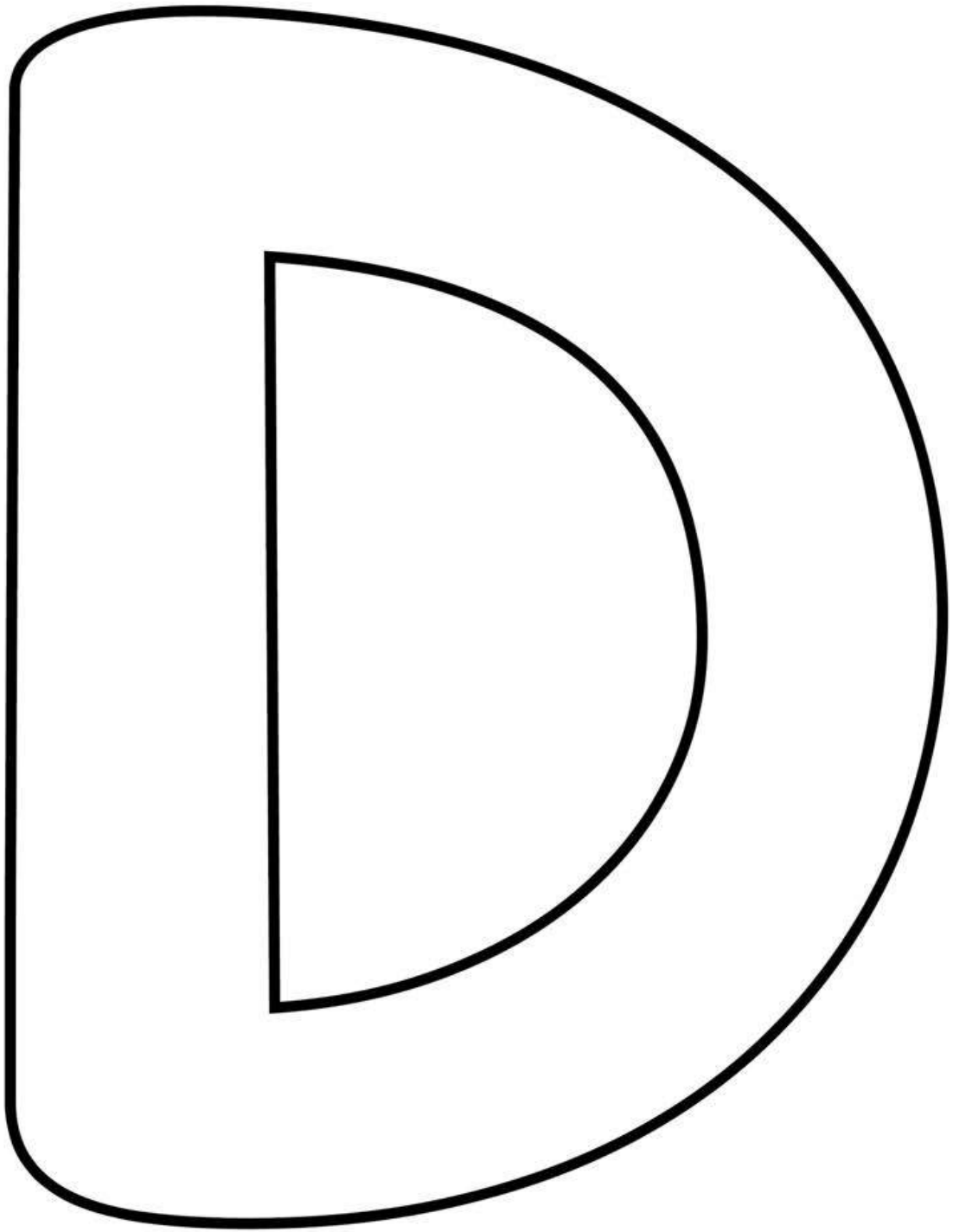

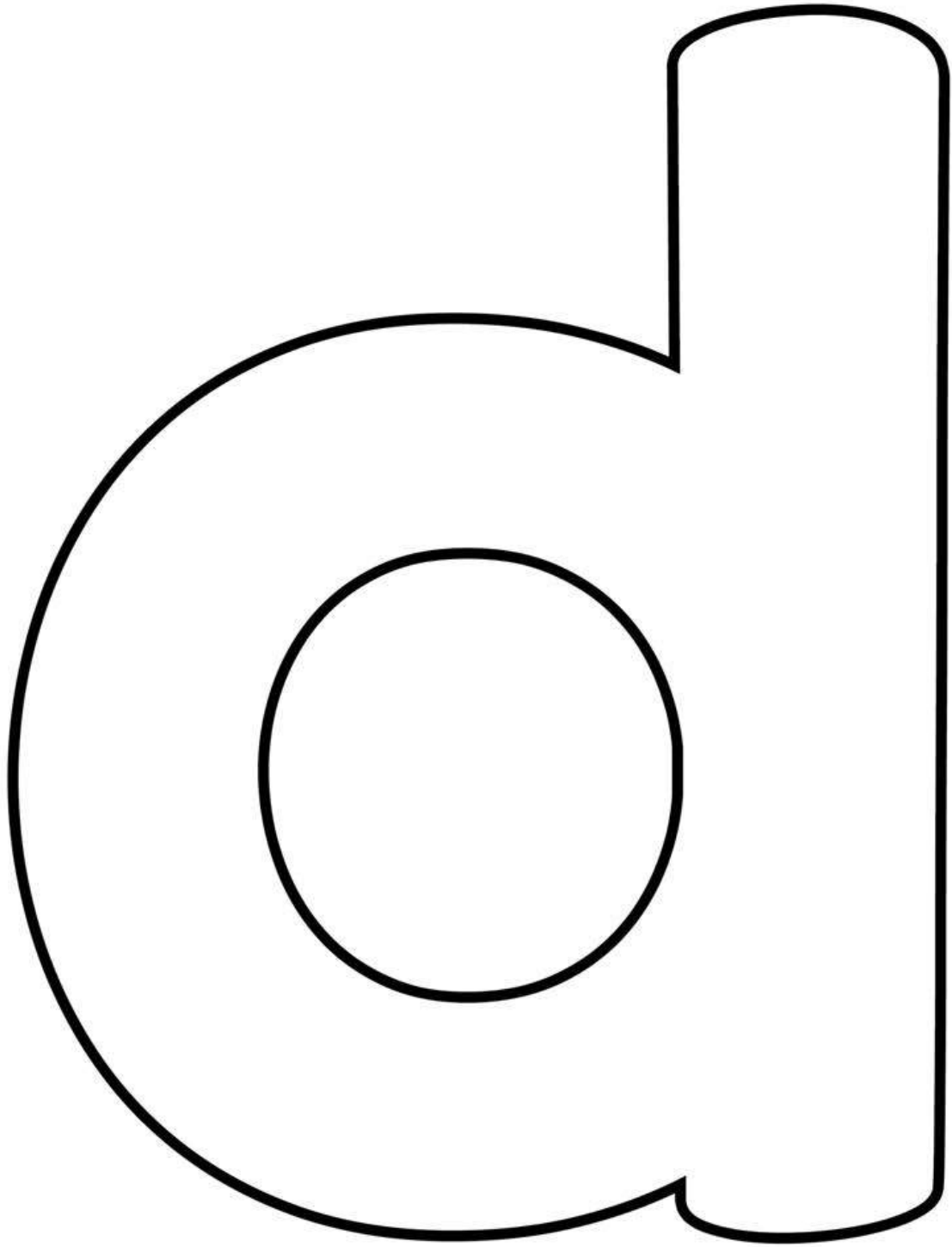

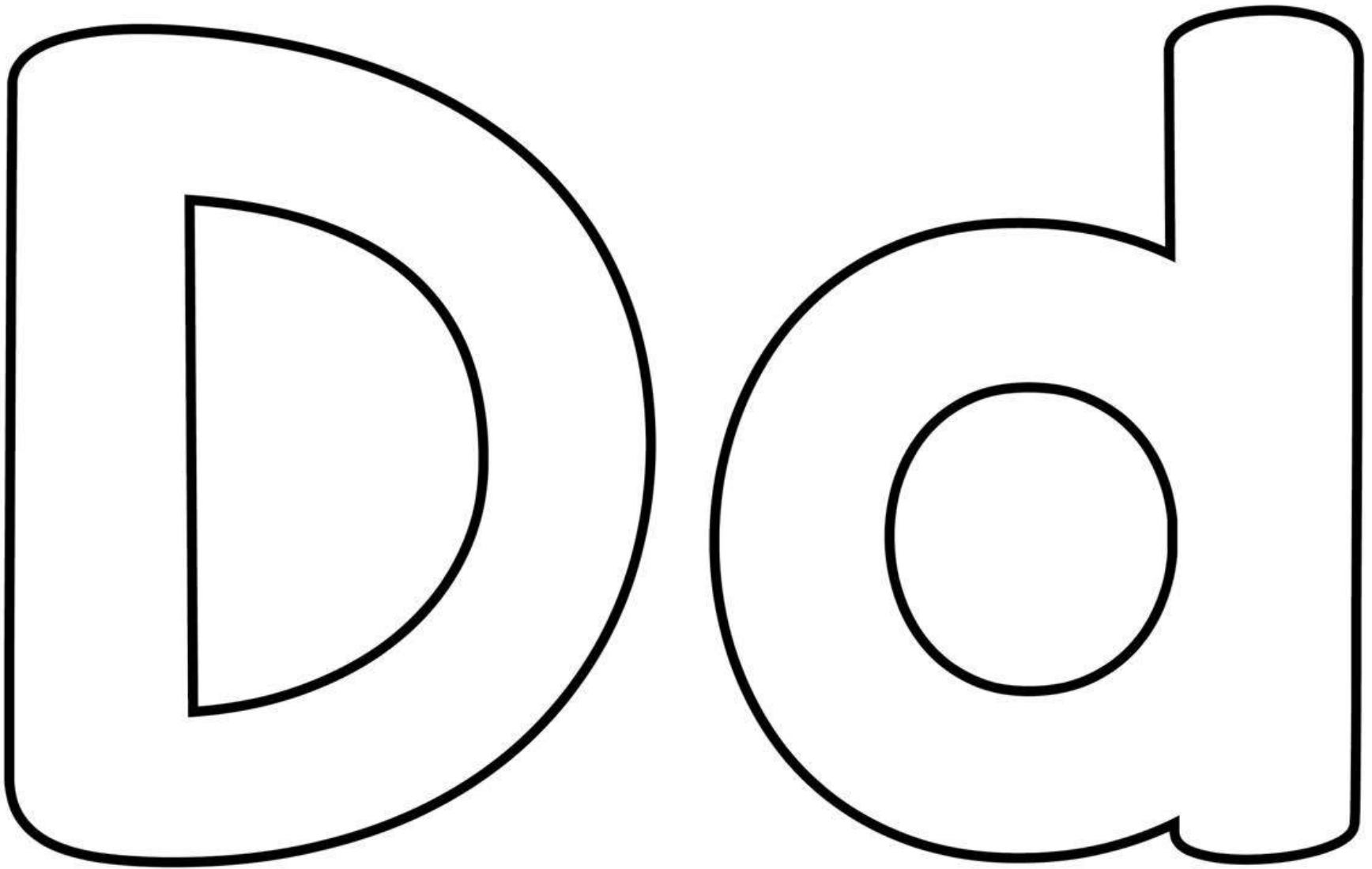

I C A N F I N D

the letter:

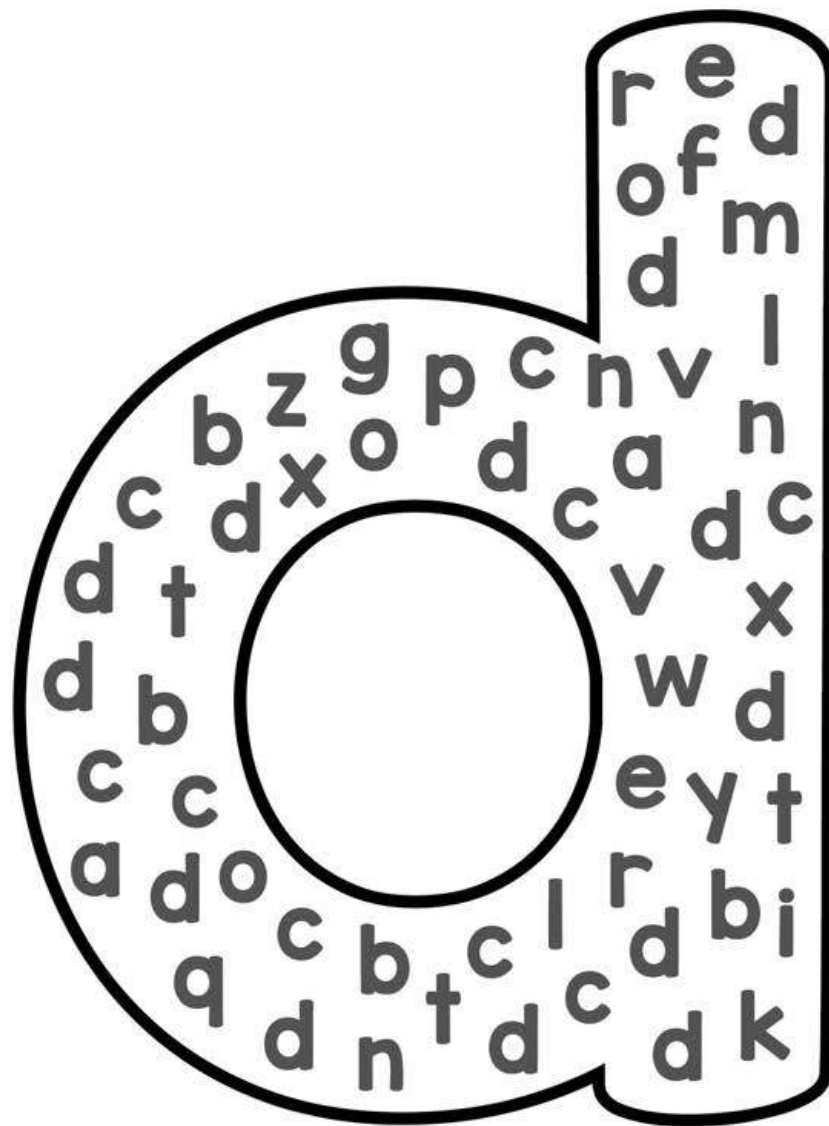
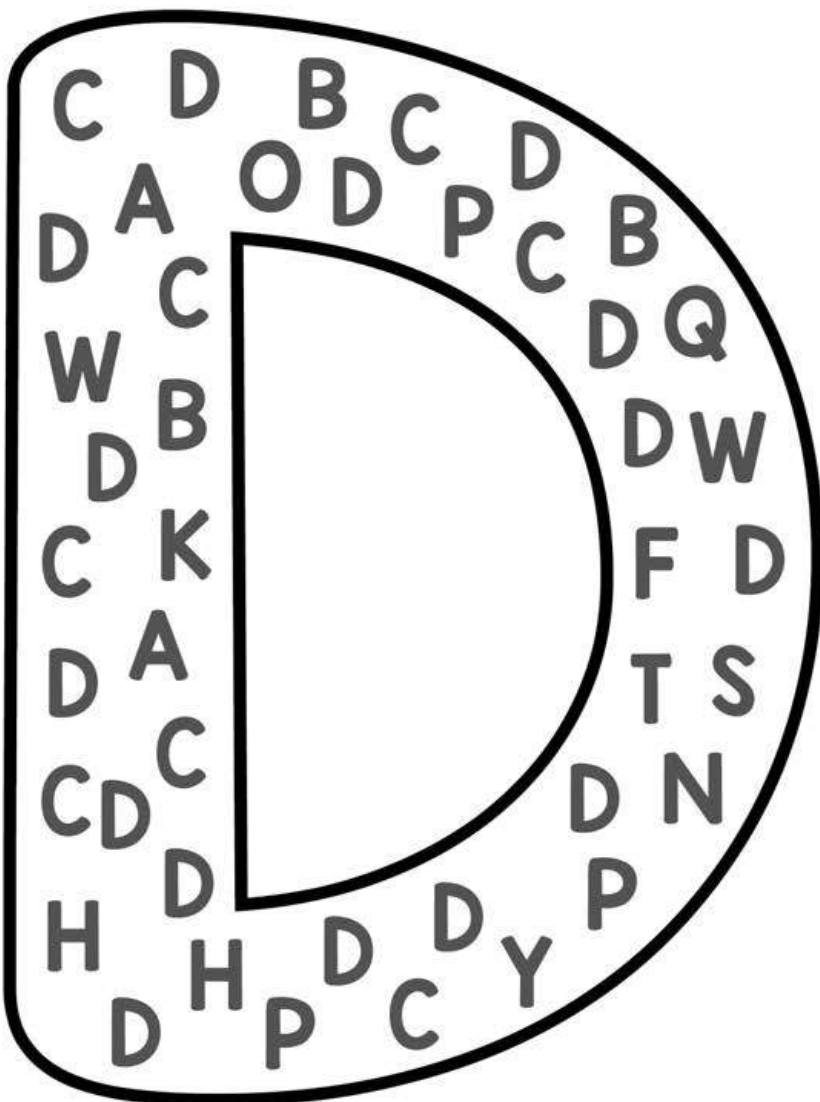

How Many?

How Many?

TRACE

NAME : _____





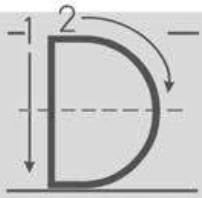

Color one for each row of letters you complete

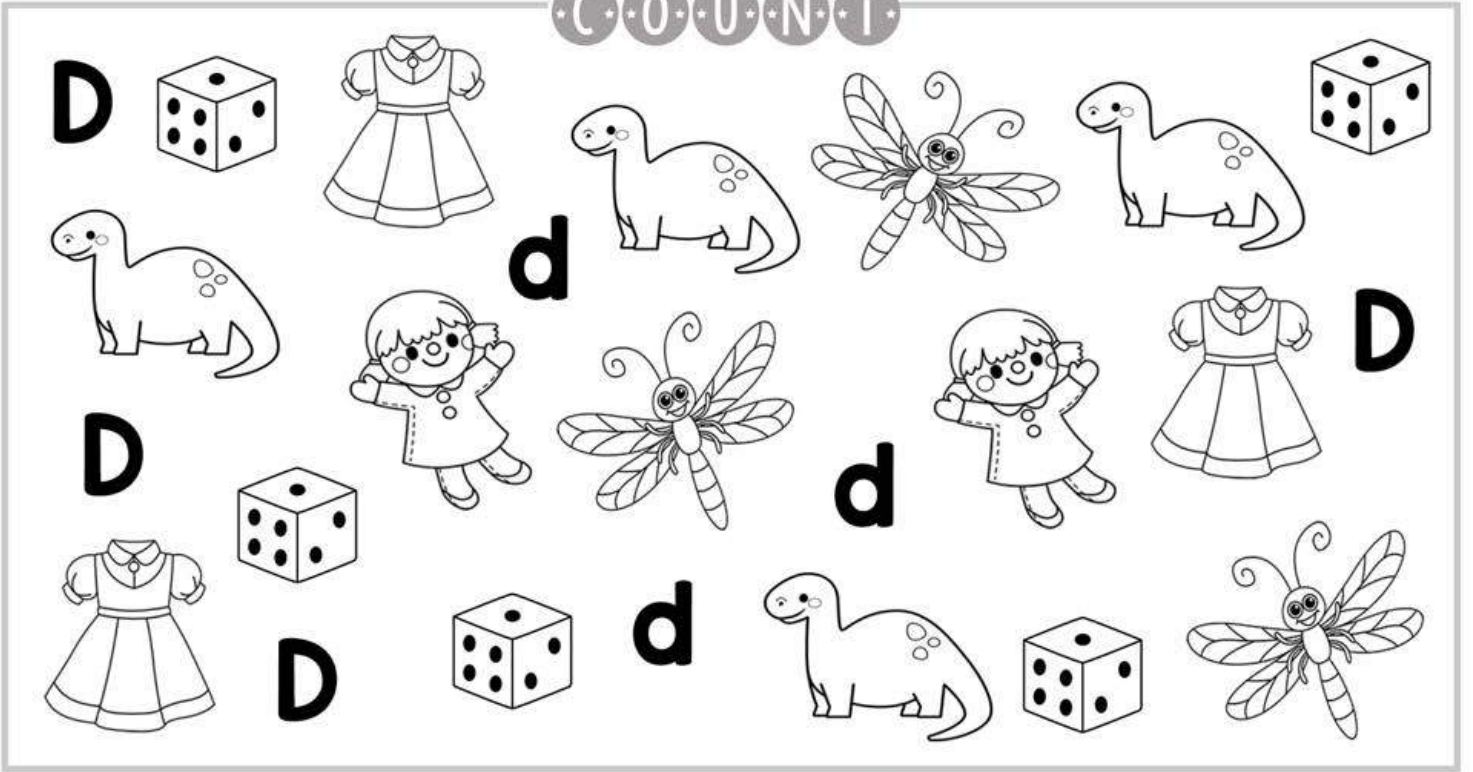

C · O · U · N · T ·

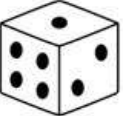

G · R · A · P · H ·

D	d					

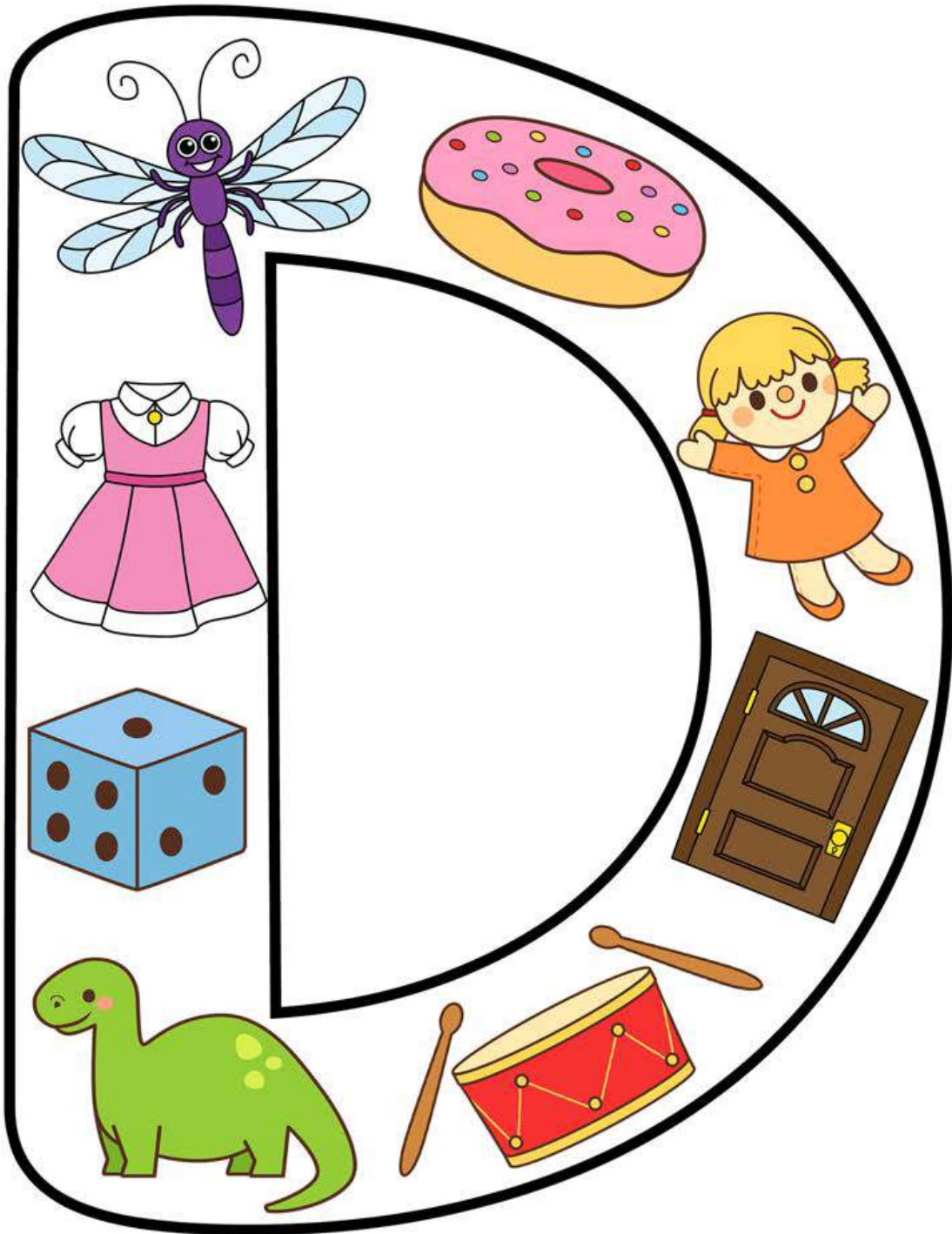

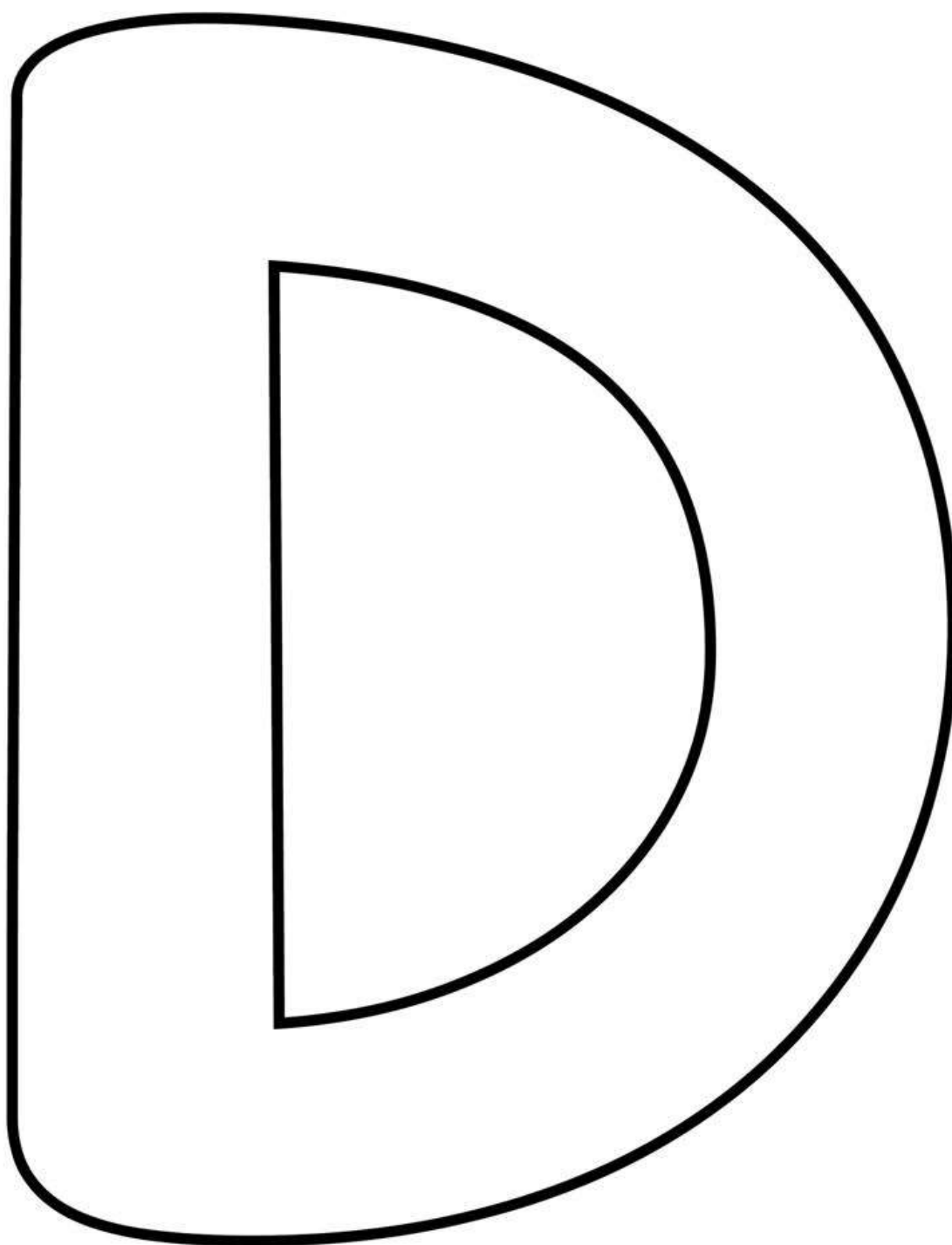

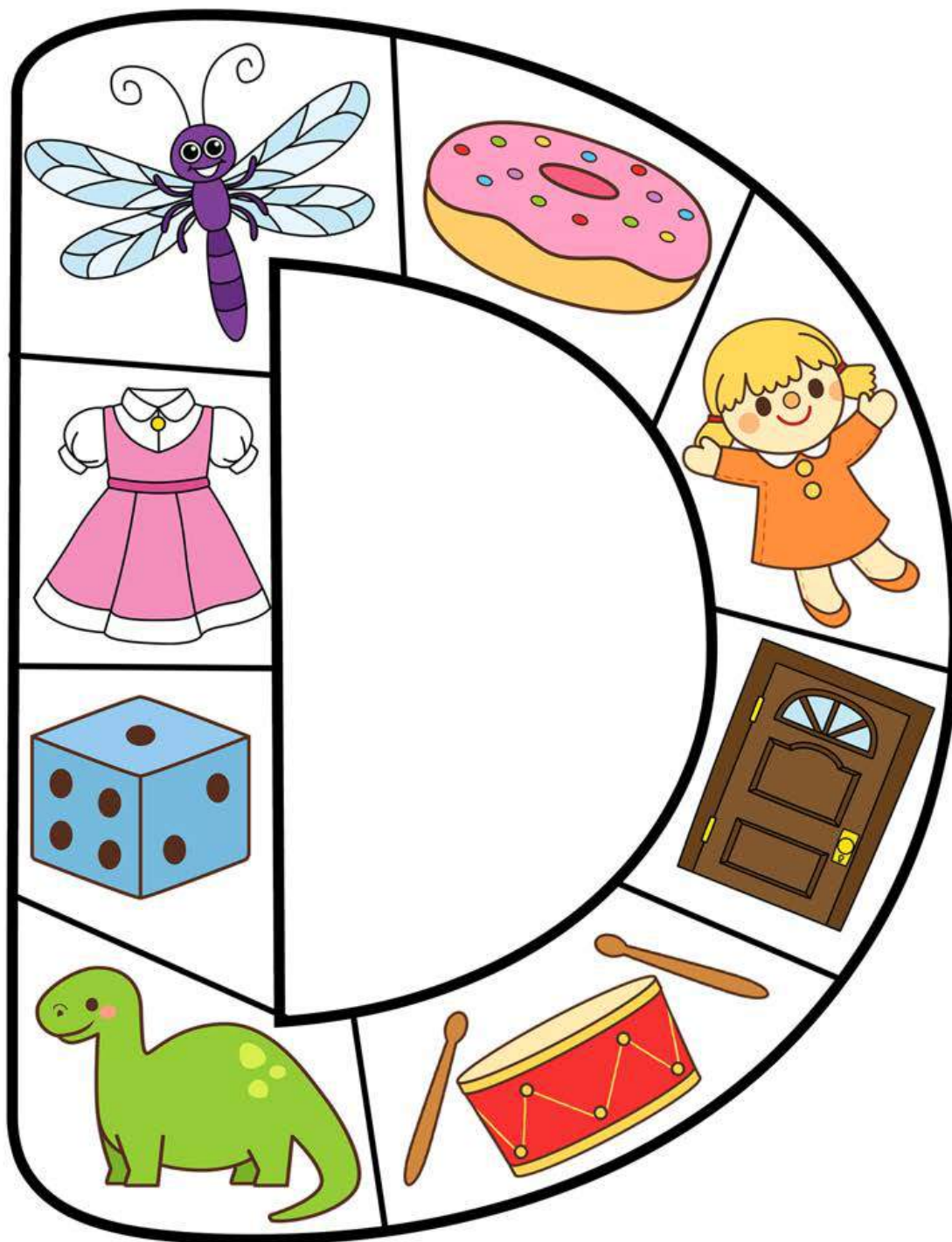

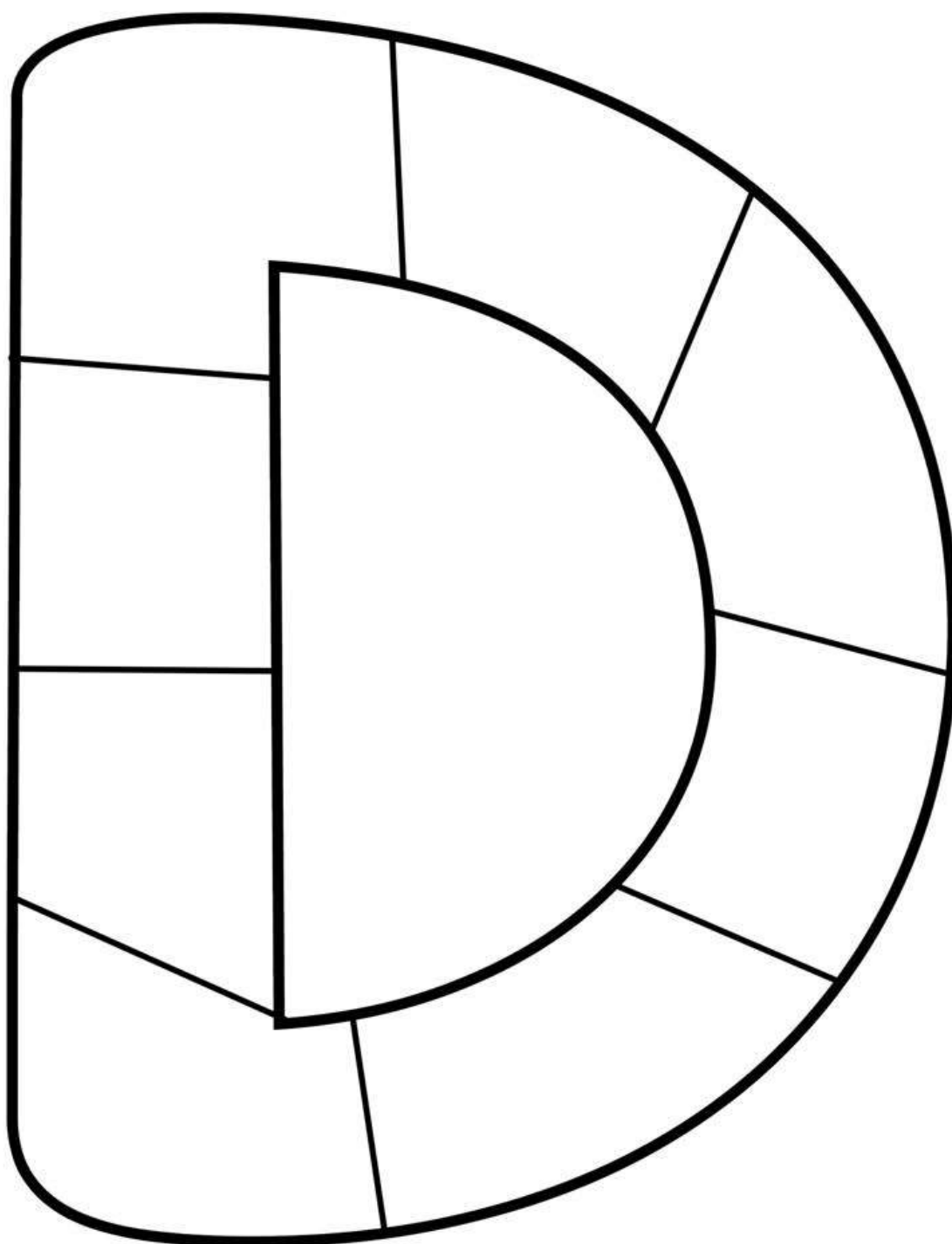

1. Write

2. Cut Out 

NAME : _____

D D

D D

d d

d d

D d

A B C Q U I L T

3. Color

4. Cut out 



NAME : _____

NAME : _____

Dd

Write and read words that begin with letter d.



uck uck

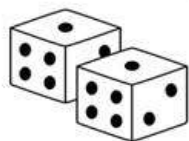

ice ice



rum rum



oor oor



ish ish ish



esk esk



inosaur

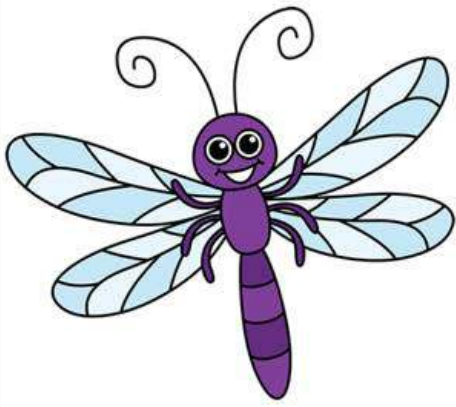

dragonfly

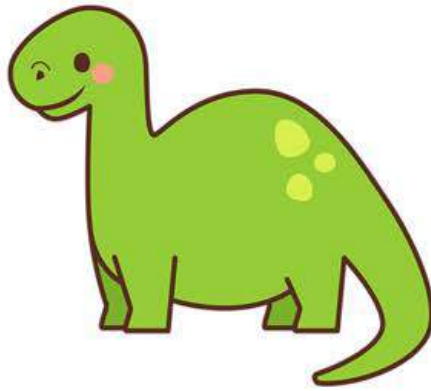

dinosaur

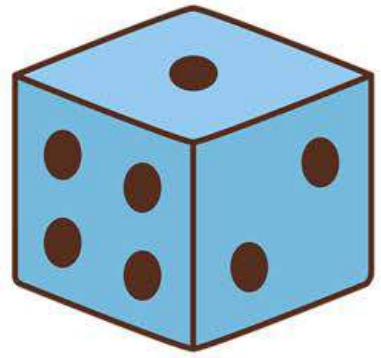

die



door

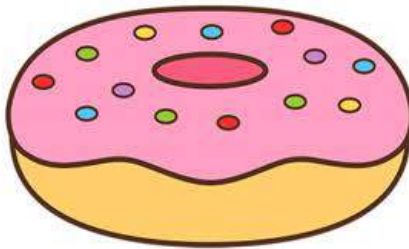

doughnut



doll



dress



drum





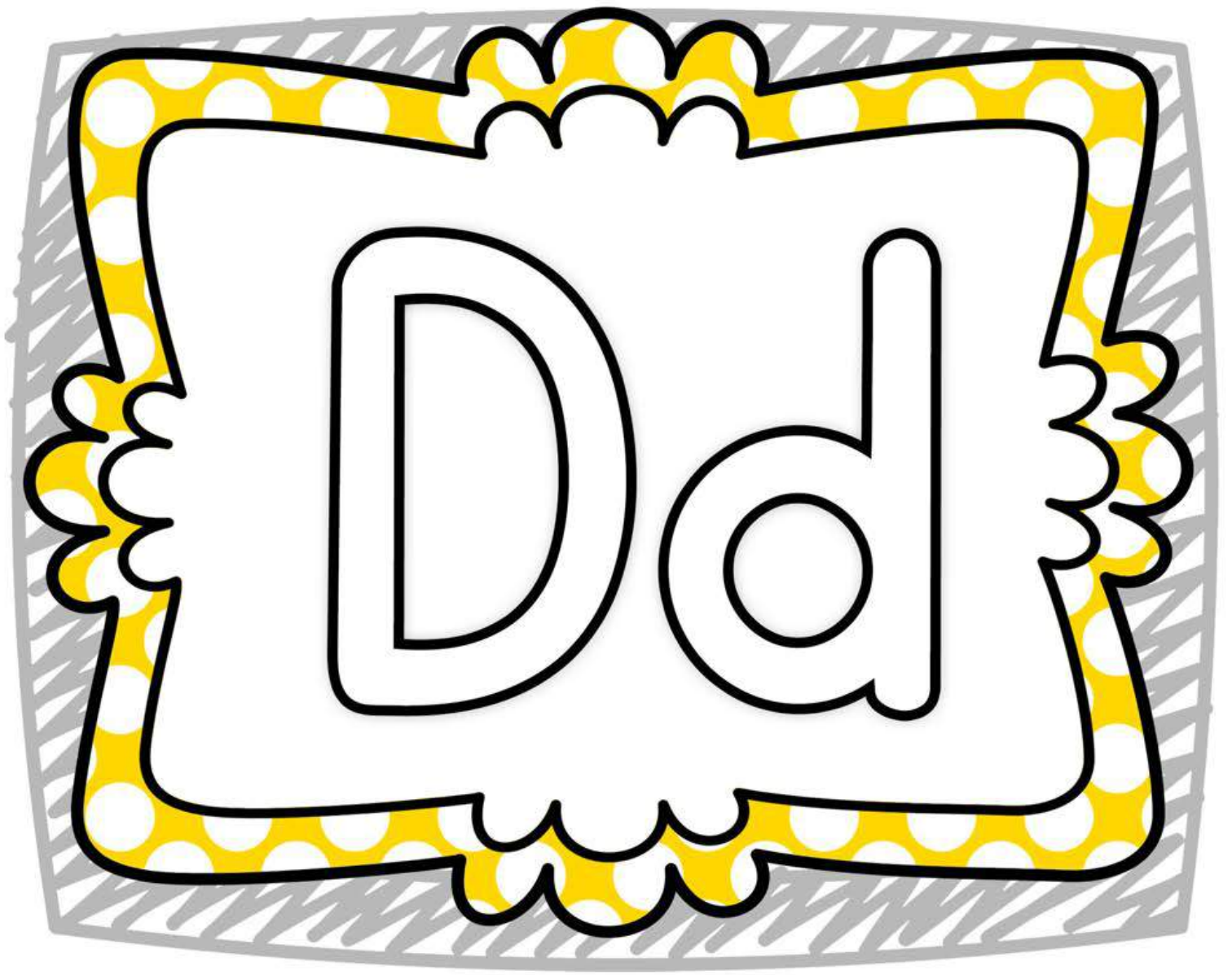









dog

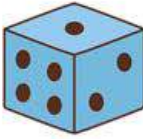

LETTER D





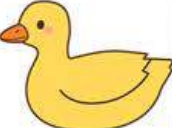
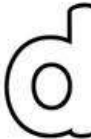











4 IN A ROW

LETTER D

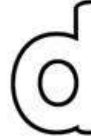

4 IN A ROW

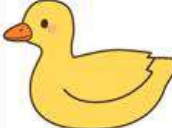
LETTER D



4 IN A ROW

LETTER D



4 IN A ROW

I C A N W R I T E

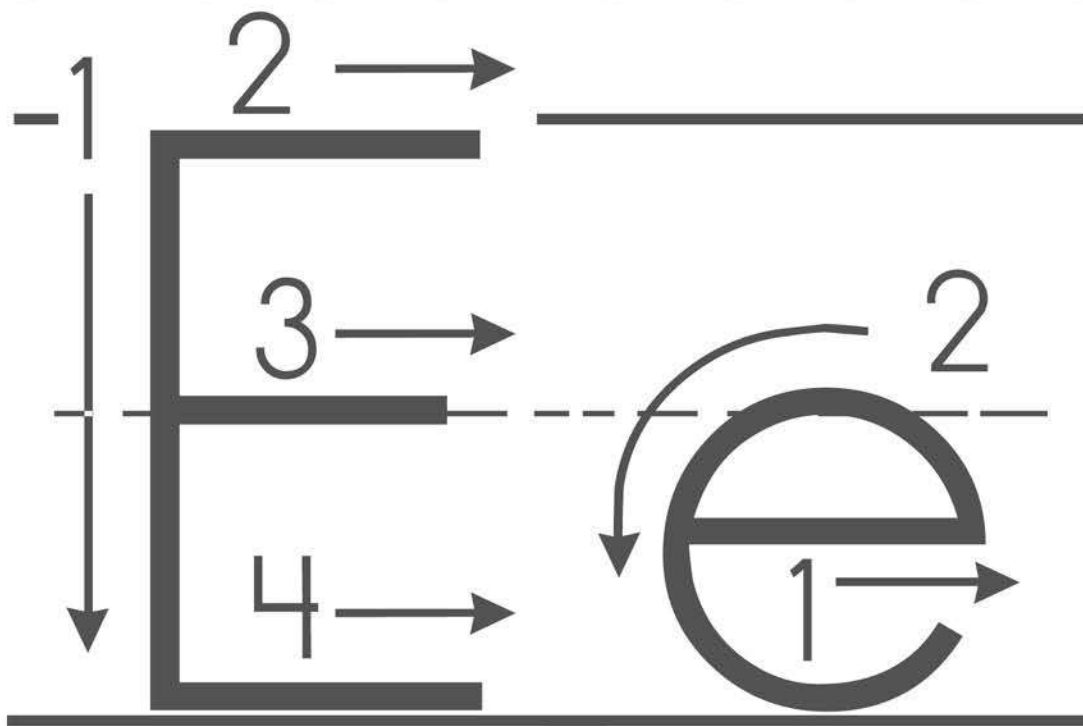

Line Down

Over

Pick up

Up & Around

Over

Over

Over

Earth

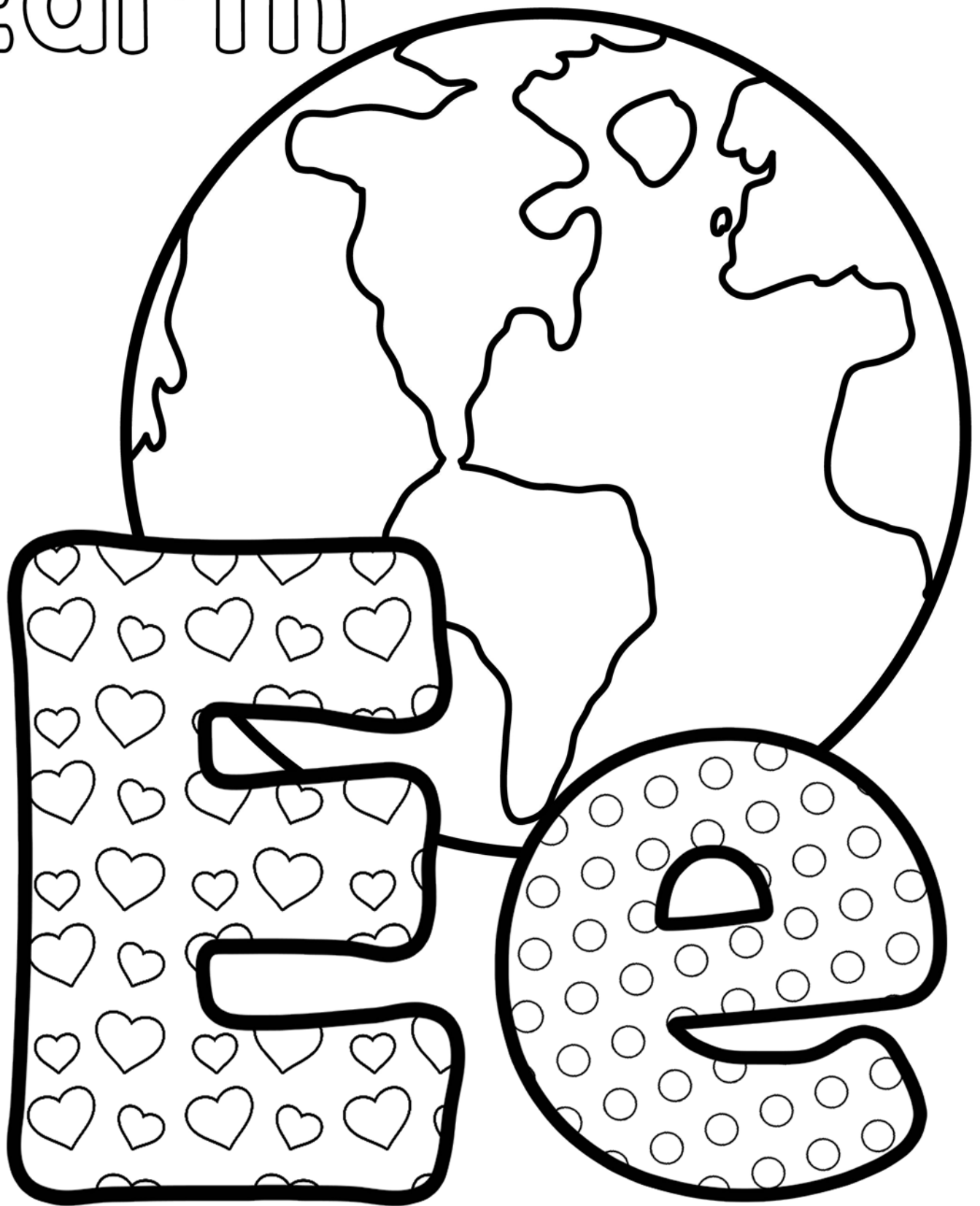

E e

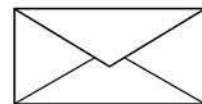
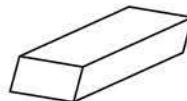
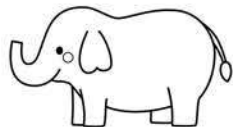
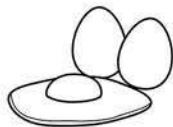
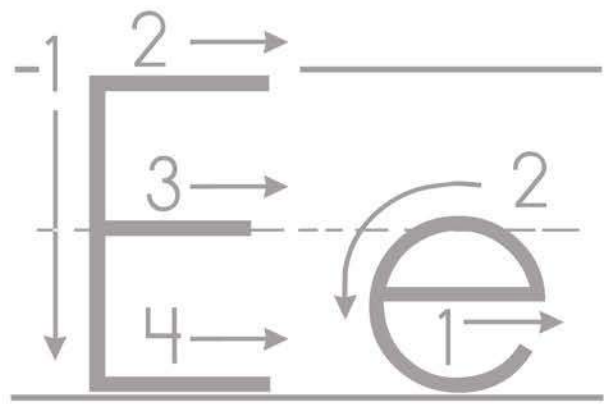

earth eggs elephant eraser eagle envelope

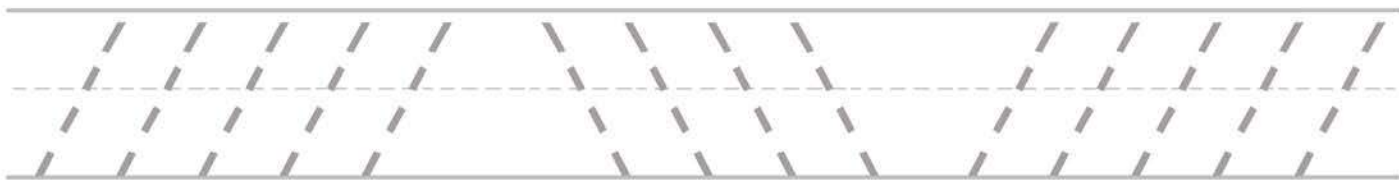

Measure:

Draw eight stars on the easel:



Trace

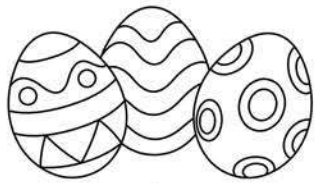
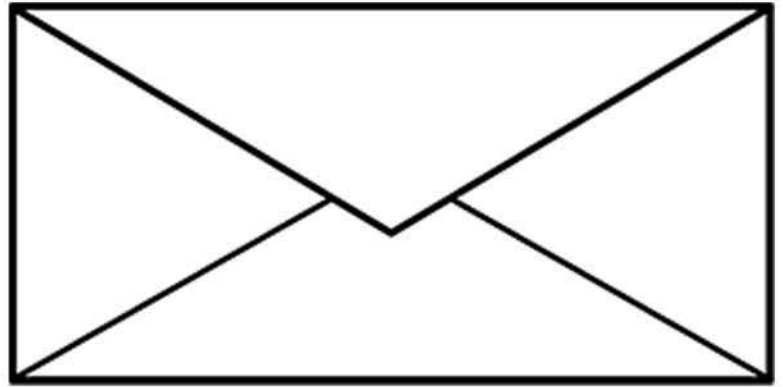
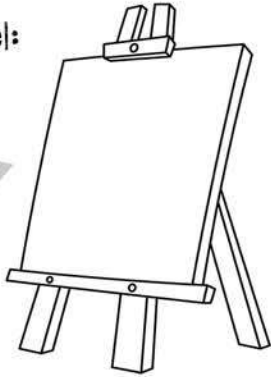

+

=

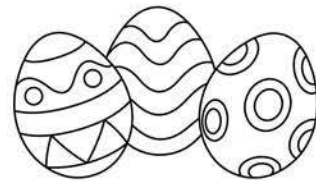

Add

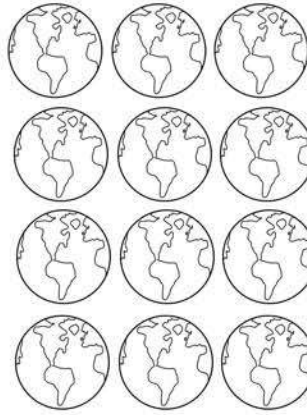

Count & Tally

$$3 + 3 = \square$$

$$4 + 3 = \square$$

$$\begin{array}{r} 3 \\ + 4 \\ \hline \square \end{array}$$

$$\begin{array}{r} 4 \\ + 3 \\ \hline \square \end{array}$$

Circle what comes next:



Label the elephants: 1st 2nd 3rd 4th

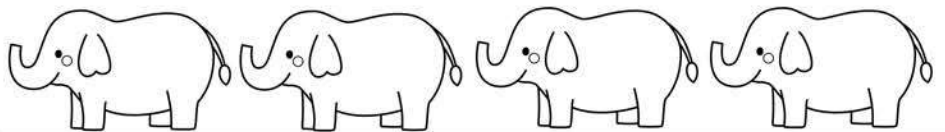

Draw: $3 + 3 = 6$

$+ =$



E

e

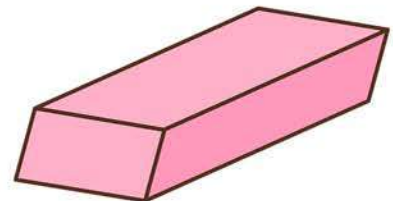
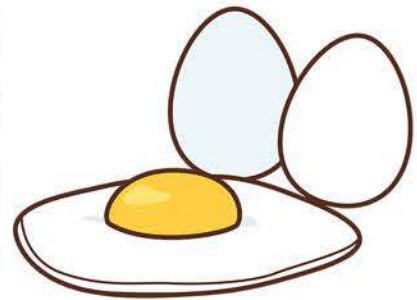
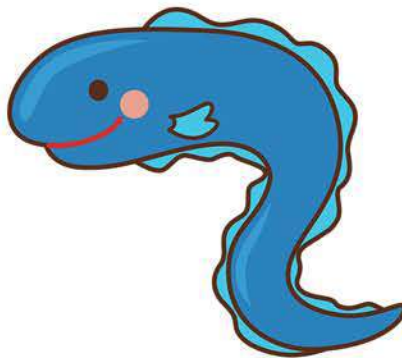
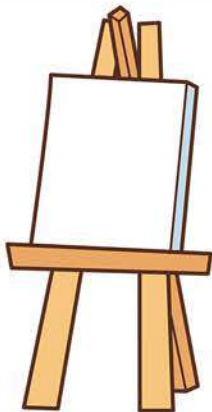
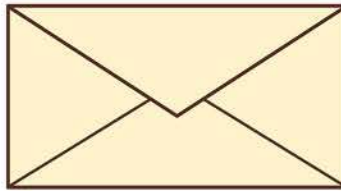
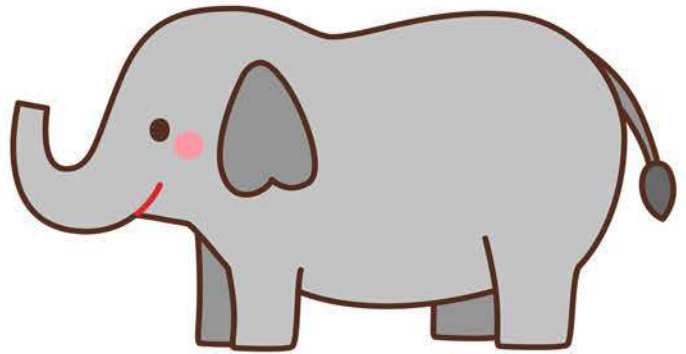

I CAN COLOR

words with:

-  = ear
-  = envelope
-  = eggs
-  = earth
-  = eel
-  = eagle
-  = eraser
-  = elephant

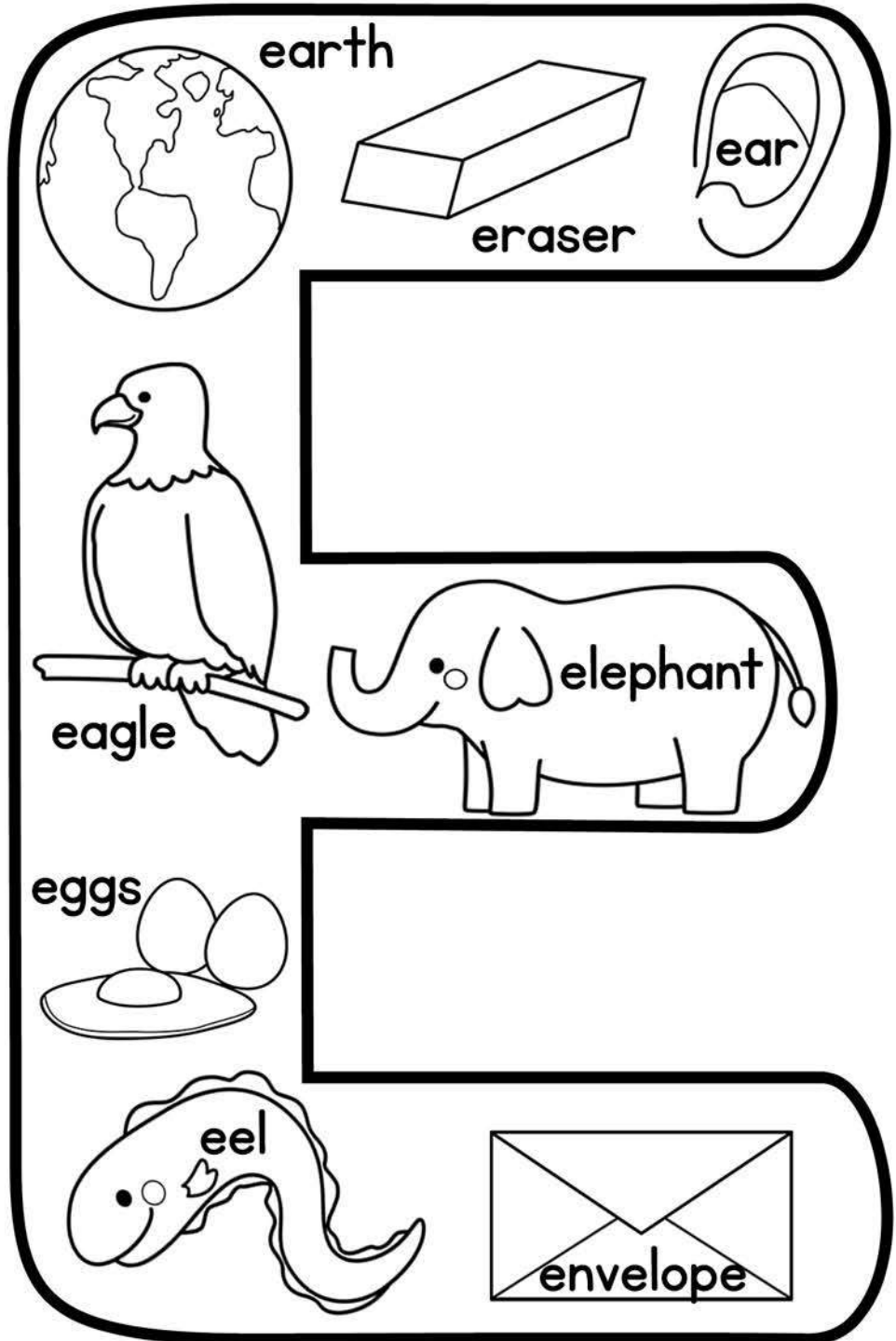

NAME : _____

Ee

Write and read words that begin with letter e.

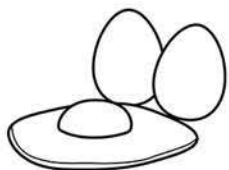

eggs eggs

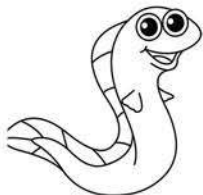

eel eel eel



ear ear ear



earth earth



elf elf elf



eagle eagle

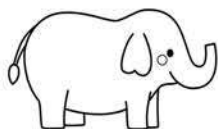

elephant

NAME : _____

Ee

Write and read words that begin with letter e.

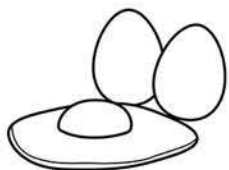

Eggs Eggs

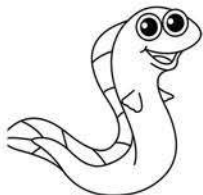

Eel Eel Eel



Ear Ear Ear



Earth Earth



Elf Elf Elf



Eagle Eagle

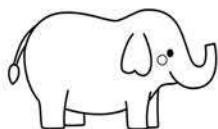

Elephant

NAME : _____

R * A * C * E * T * O * T * H * E * T * O * P

Use a paperclip and a pencil to complete the spinner.

E	e
E	e
E	e
E	e
E	e
E	e
E	e
E	e
E	e
E	e

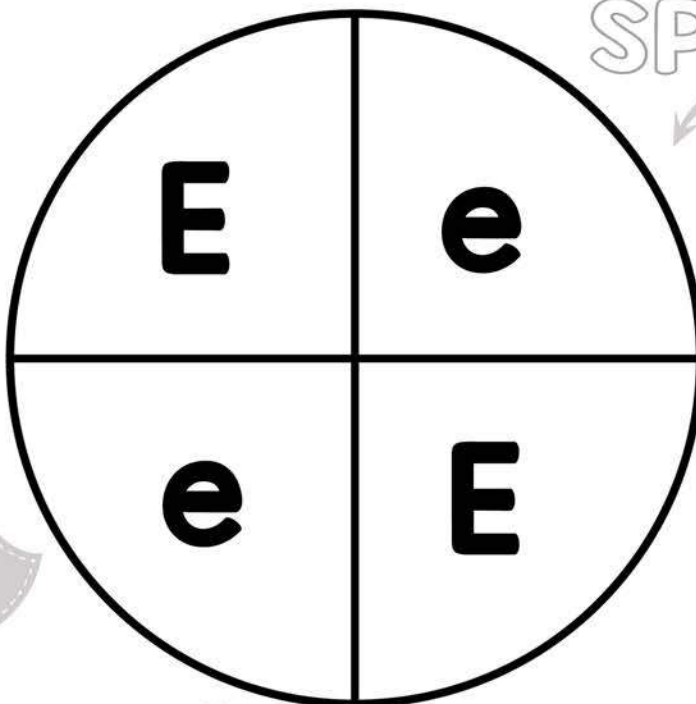

SPIN



Record

Report:

How many spins landed on E?

How many spins landed on e?

Which had more?

Write an inequality: >

How many spins total?

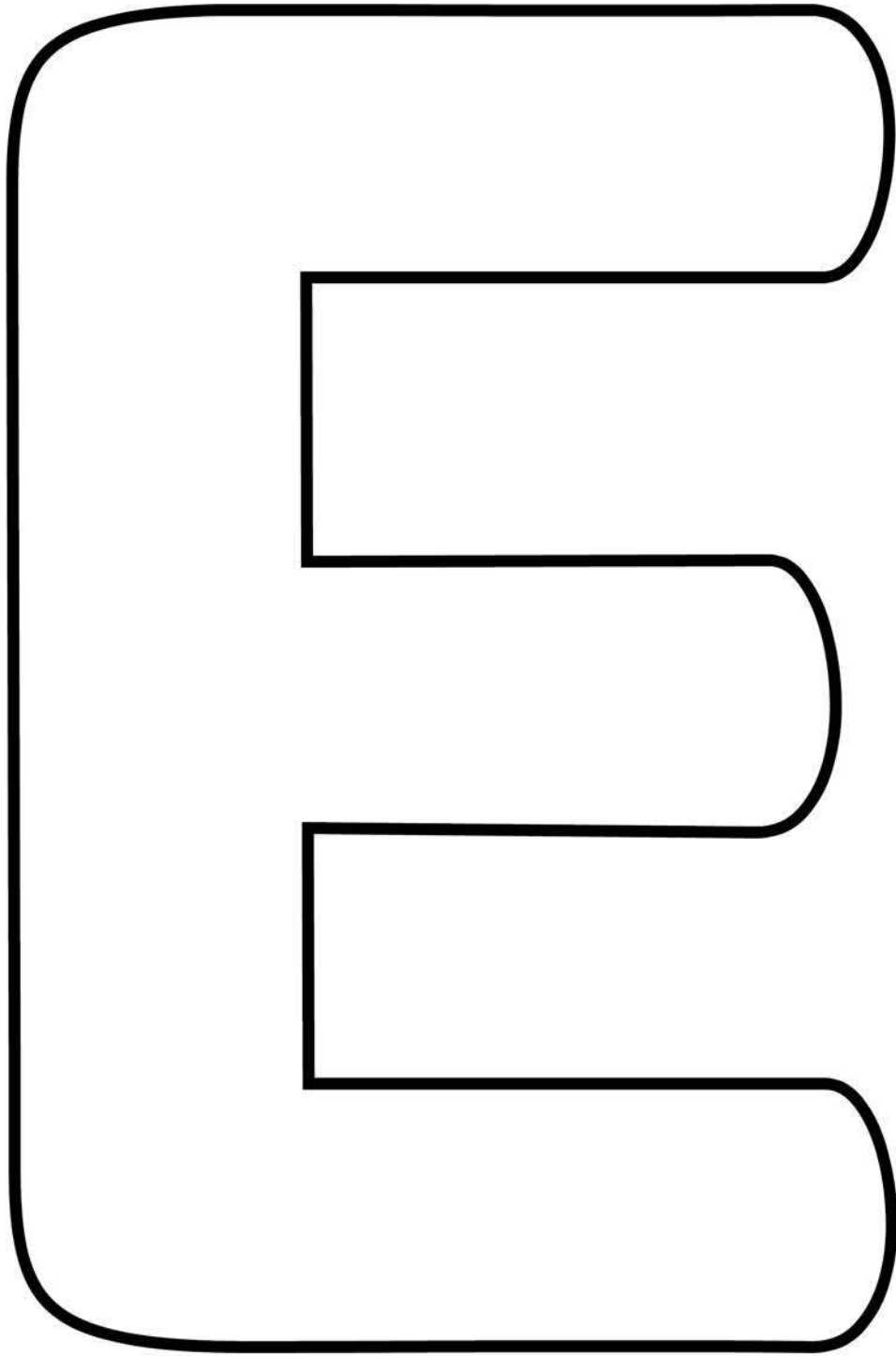

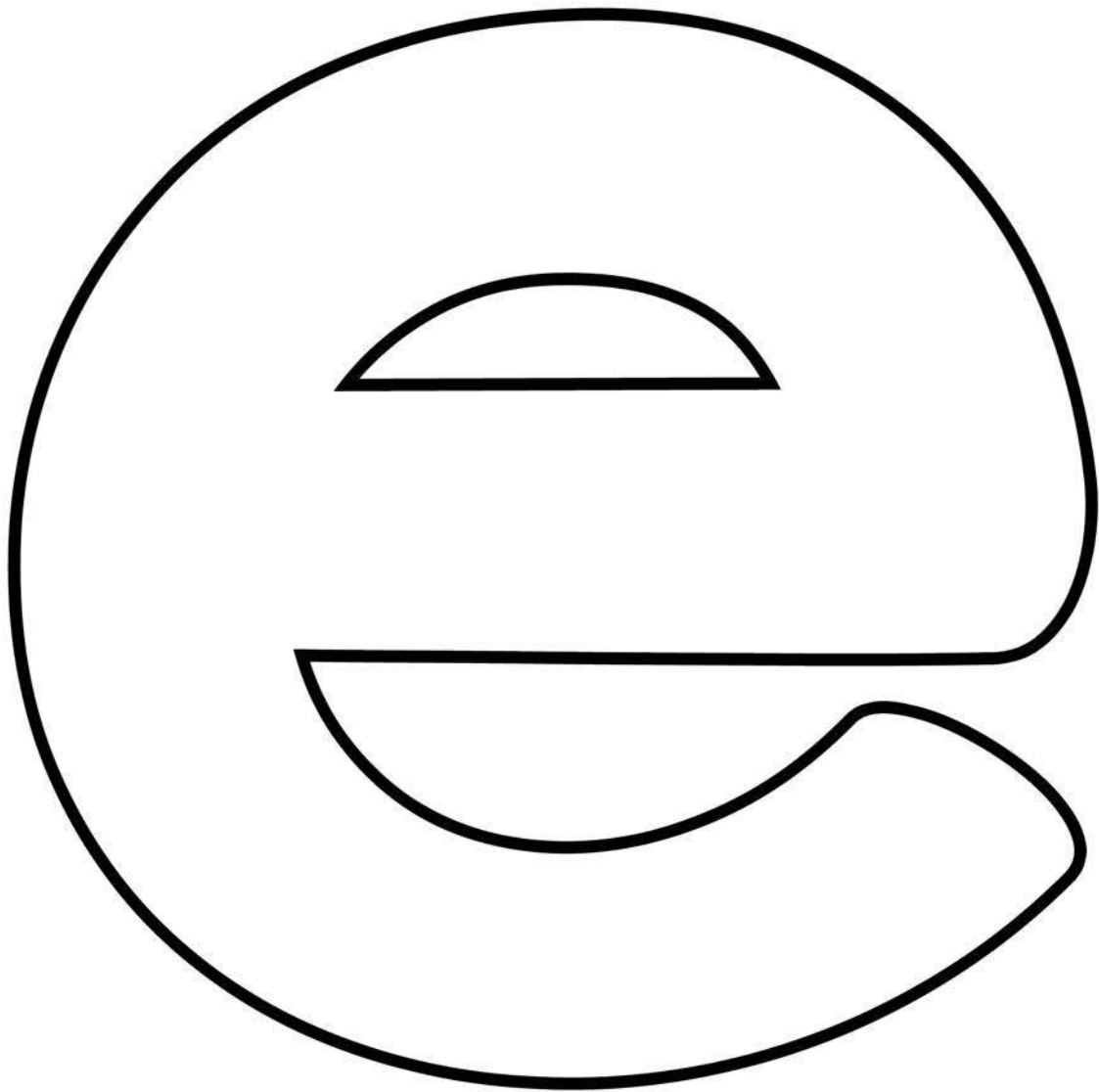

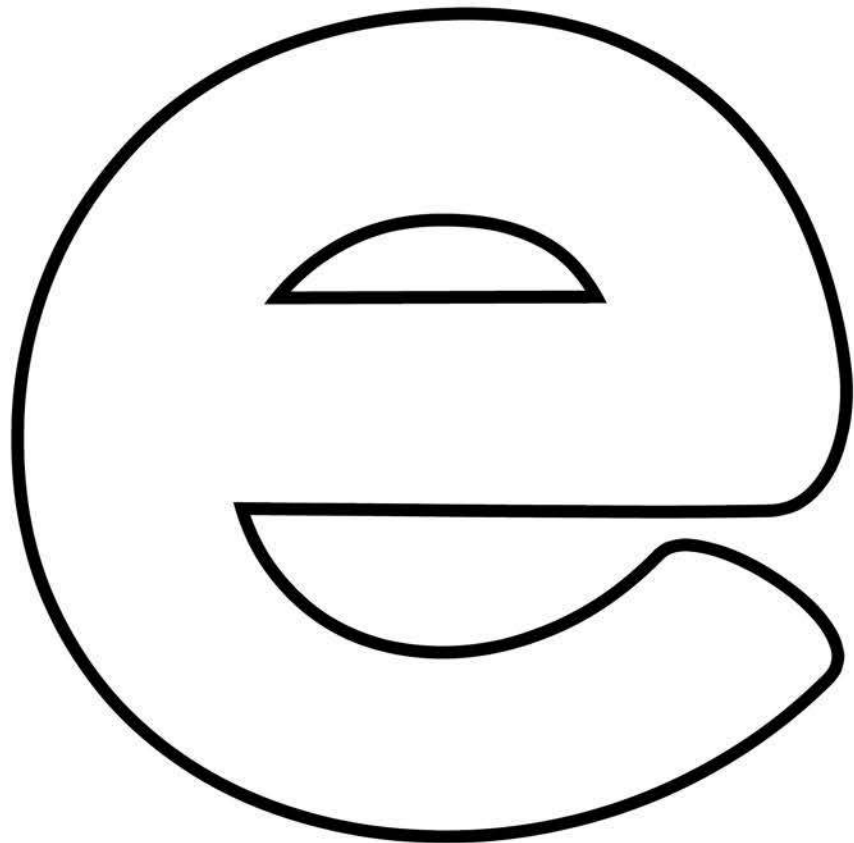
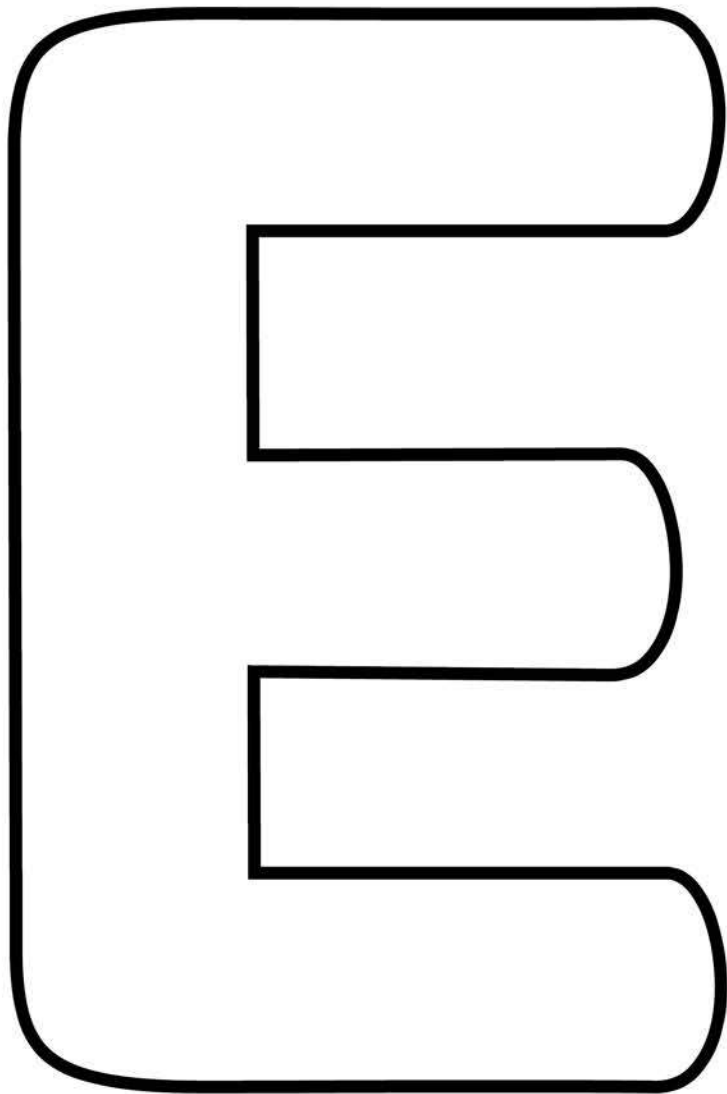

I C A N F I N D

the letter:

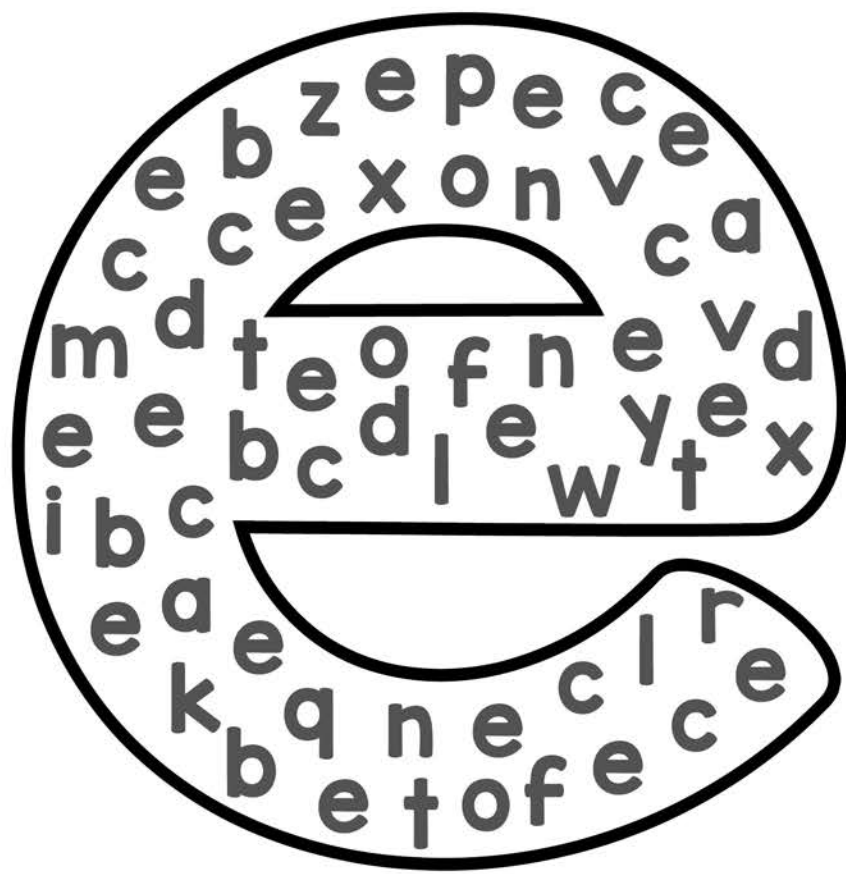
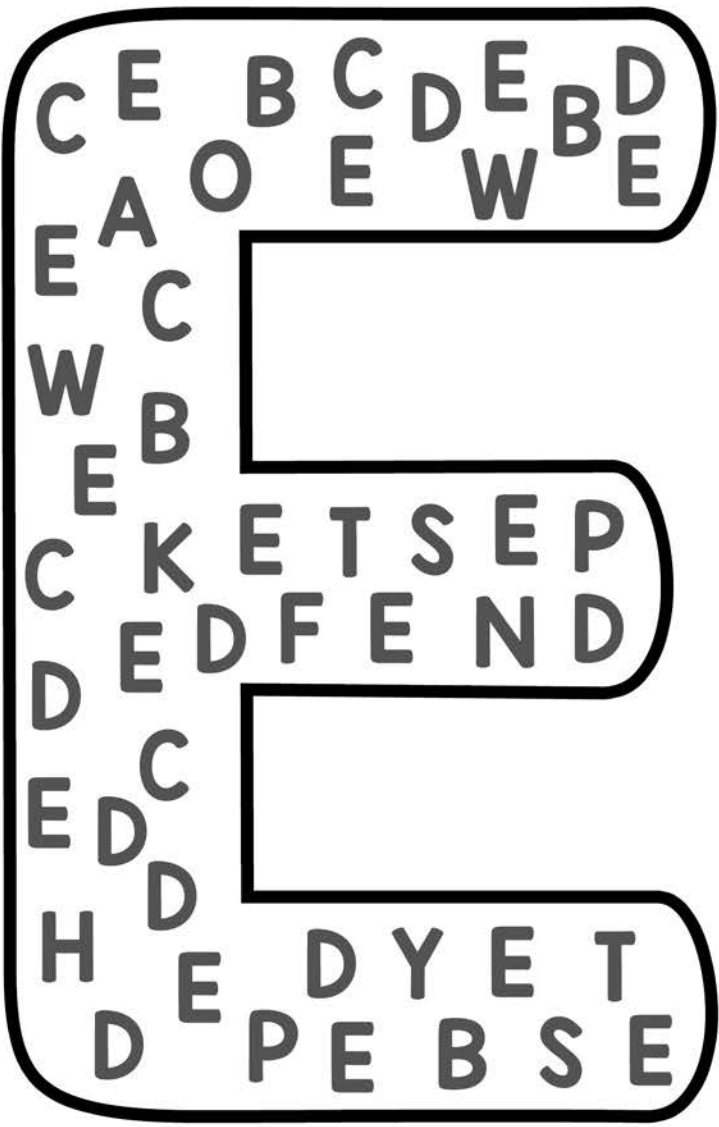

How Many?

How Many?

TRACE

NAME : _____



Color one for each row of letters you complete

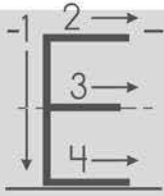

E E E E E E

E E E E E E E E

E E E E E E E E

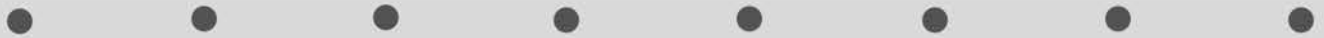

e e e e e e e e

e e e e e e e e

e e e e e e e e



C O U N T

Counting exercise for the letter 'E'. The page contains 15 instances of the letter 'E' (both uppercase and lowercase) and 15 corresponding illustrations: a globe, a lizard, an envelope, a plate with two eggs, and an elephant. The items are scattered across the page for counting.

G R A P H

Graphing exercise for the letter 'E'. A 6x7 grid is provided. The bottom row contains a key for the graphing: uppercase 'E', lowercase 'e', a globe, an elephant, a lizard, an envelope, and a plate with two eggs. The remaining five rows of the grid are empty for data entry.

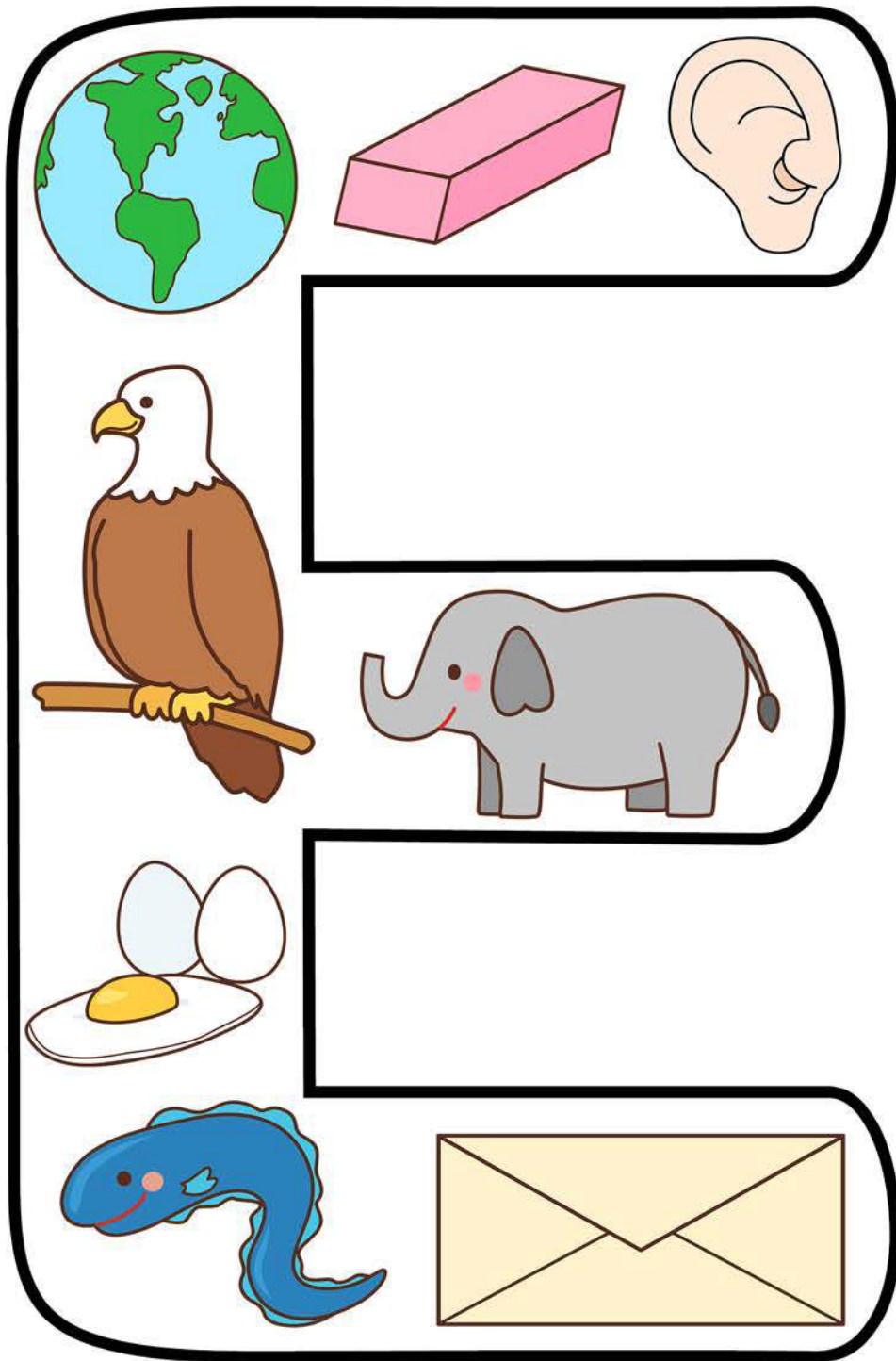

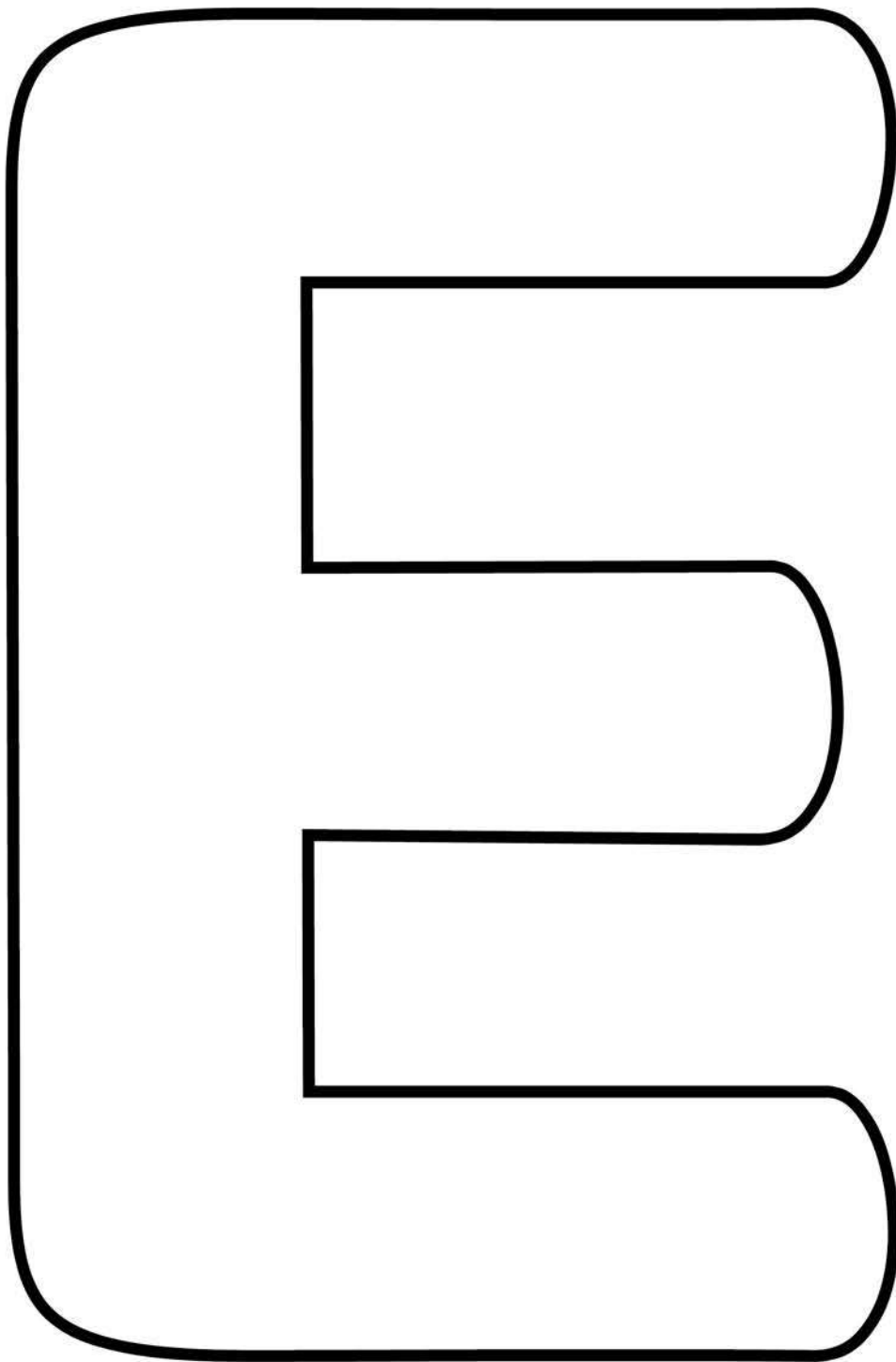

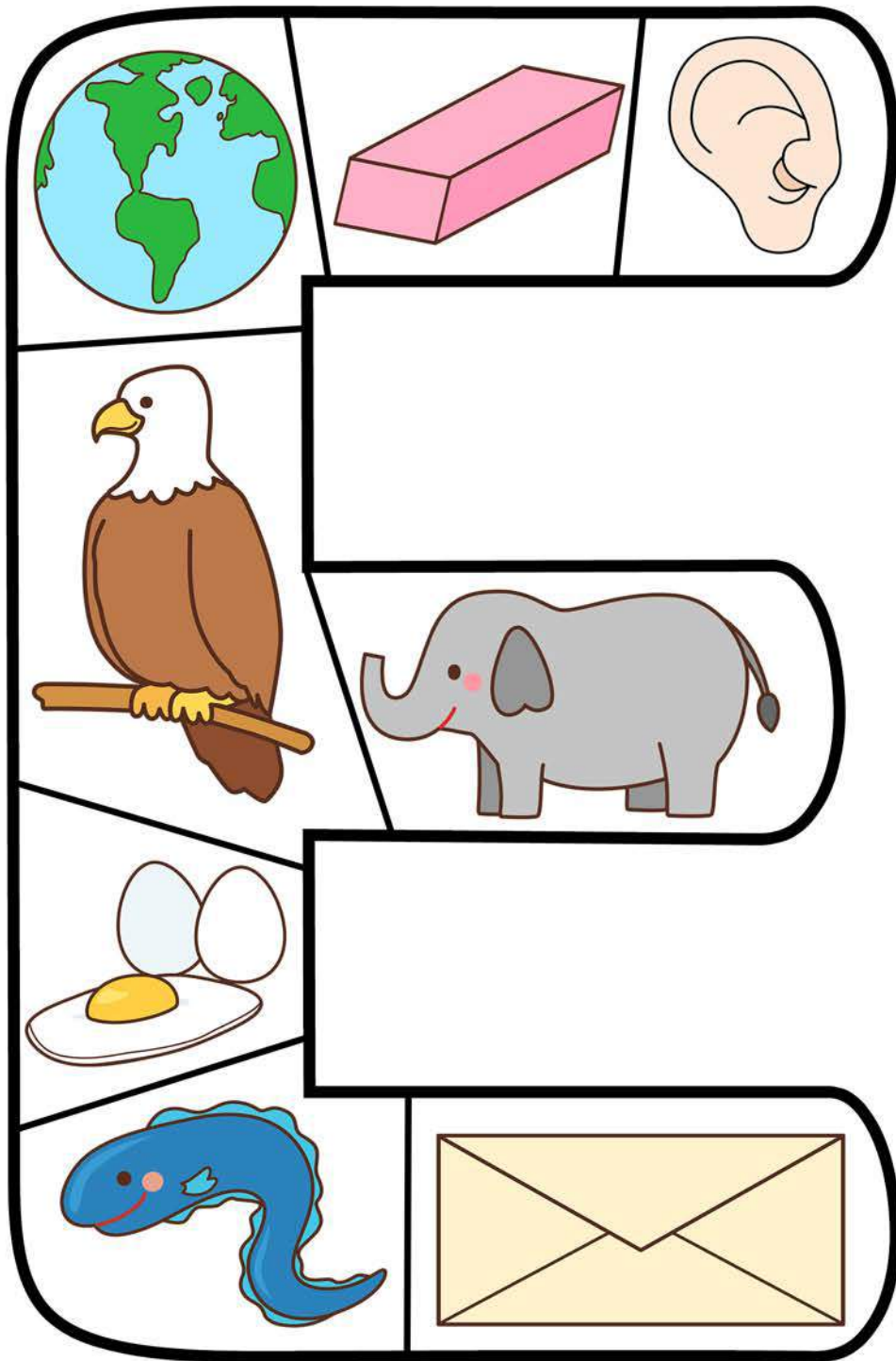

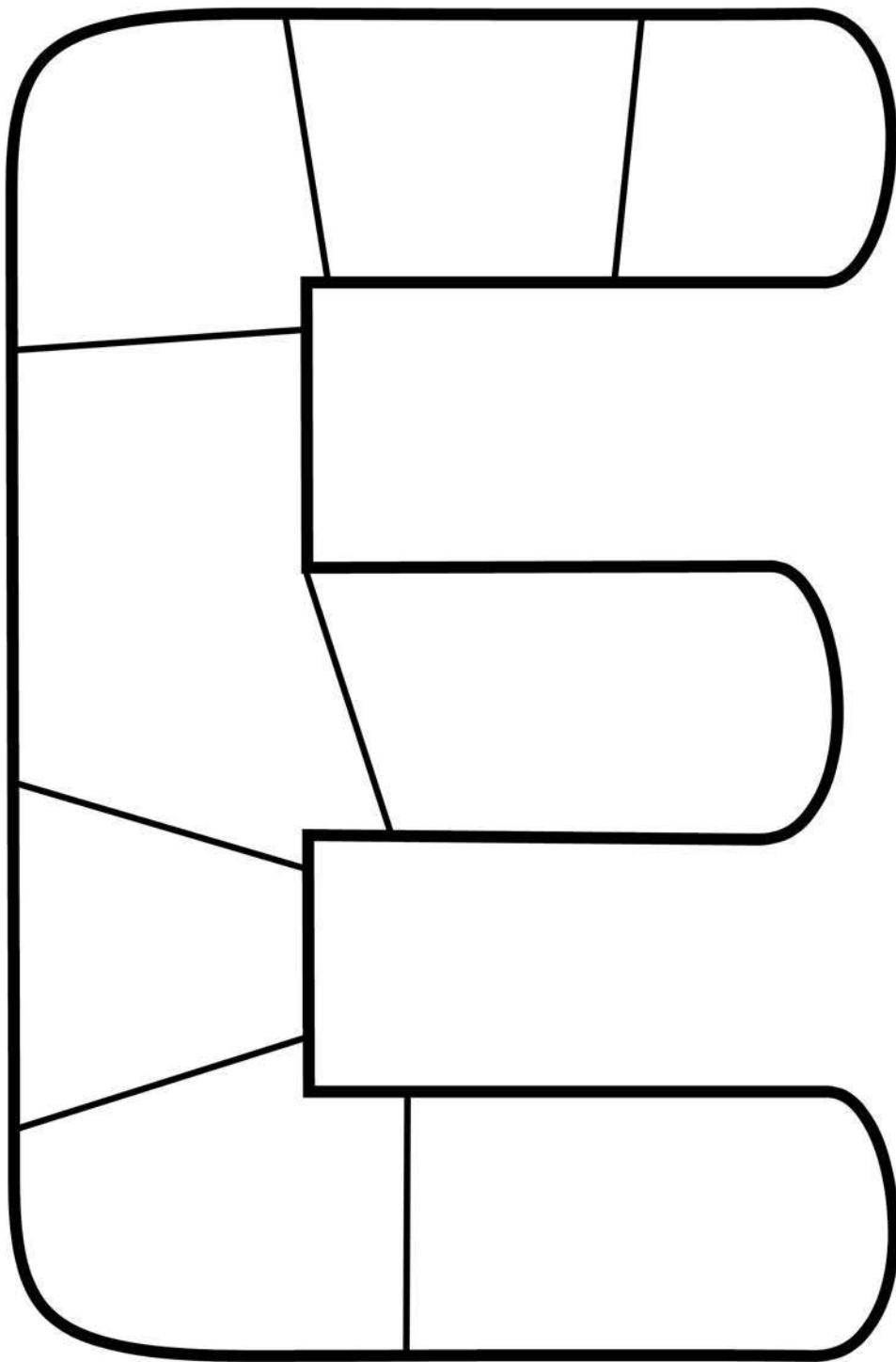

NAME : _____

Ee

Write and read words that begin with letter e.

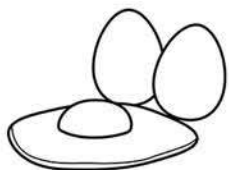

eggs eggs



eel eel eel



ear ear ear



earth earth



elf elf elf



parrot parrot

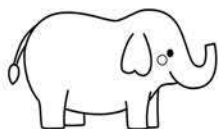

elephant



earth

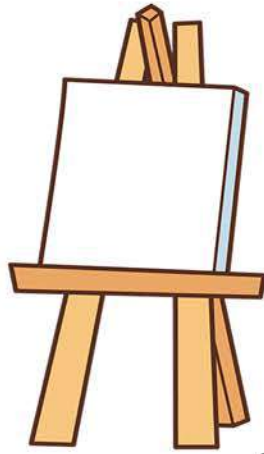

easel



elf



ear

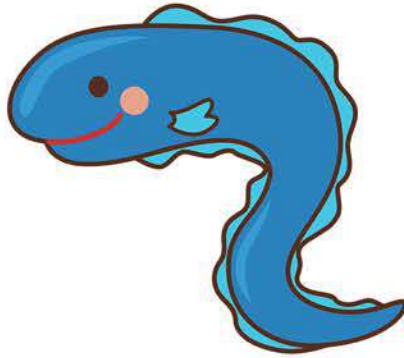

eel



eagle

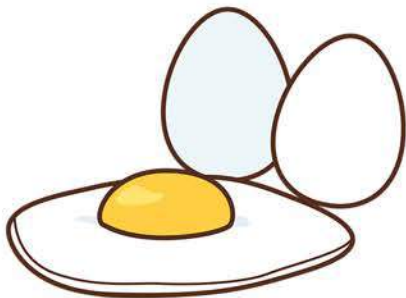

eggs

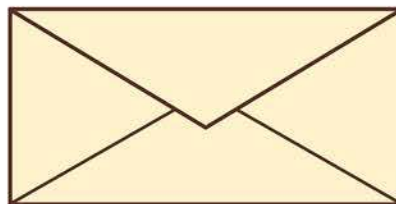

envelope

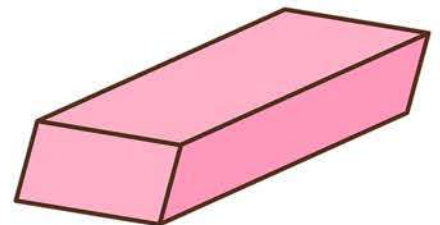

eraser

Images (c) Little Red's Clipart & Zip-de-dah-do-da Designs & Ink N Little Things

LETTER E



4 IN A ROW

LETTER E













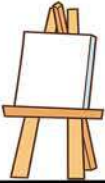

4 IN A ROW

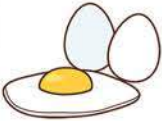
LETTER E



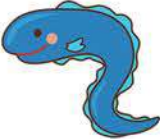
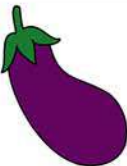

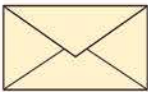







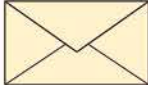

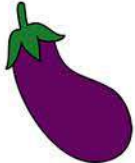
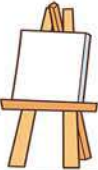
4 IN A ROW

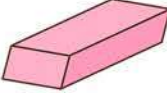

LETTER E

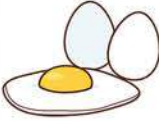

4 IN A ROW

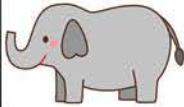

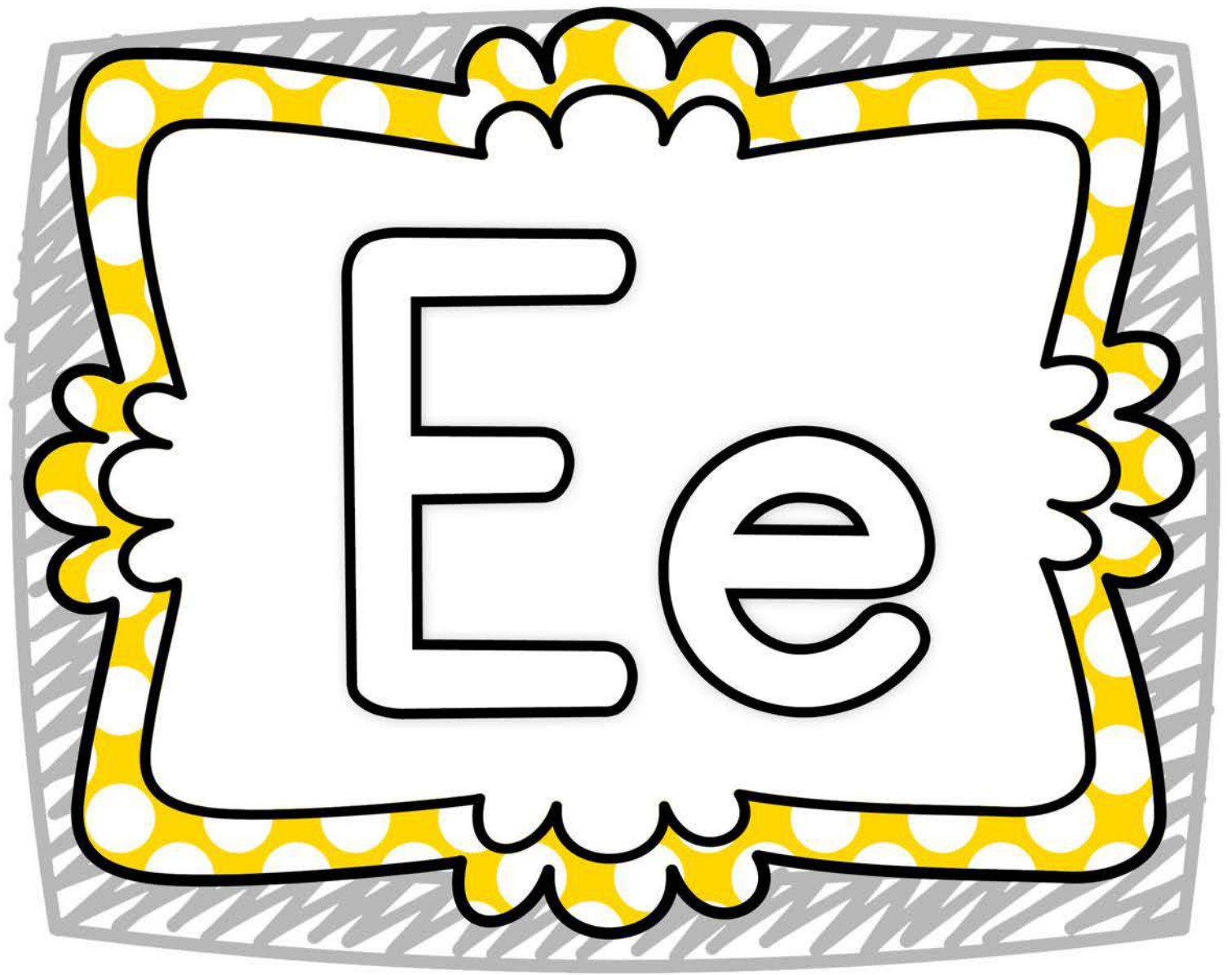
I C A N W R I T E

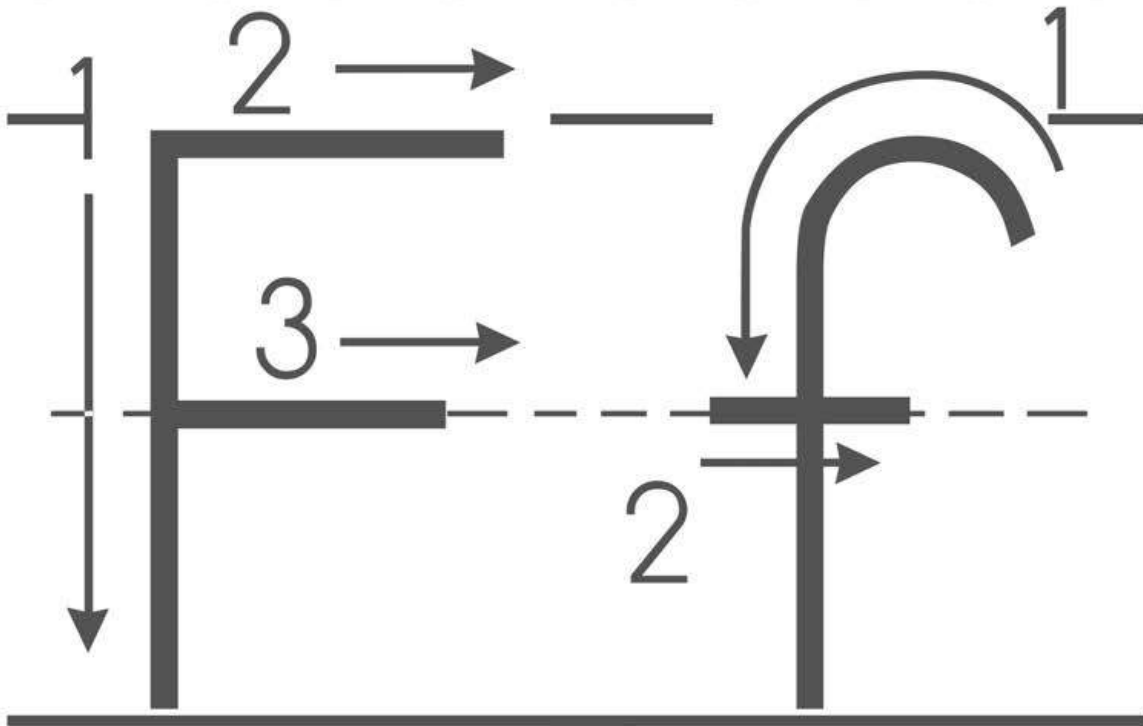

Line Down
Pick up
Over
Over

Up Around &
Line Down
Pick up
Across

Fairy

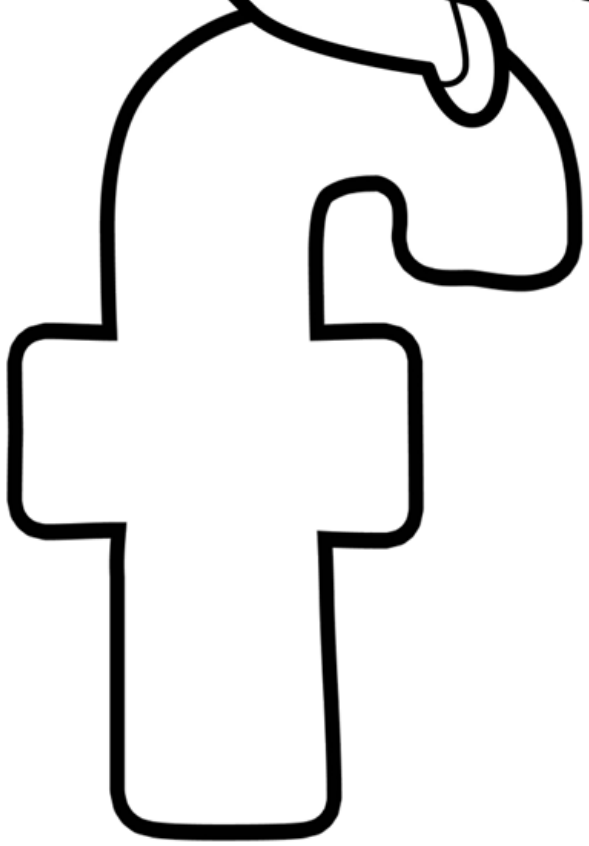
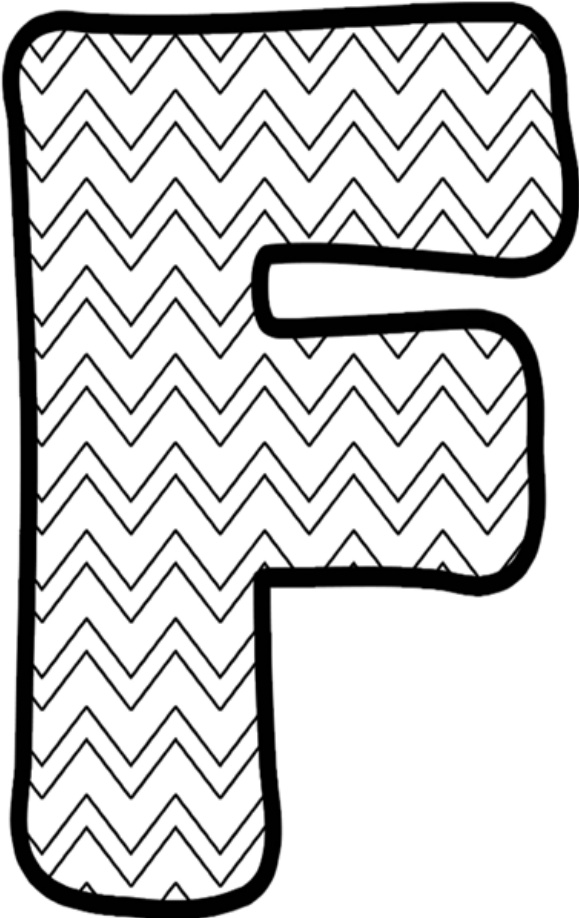

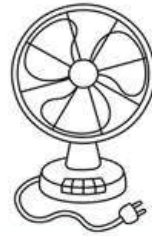
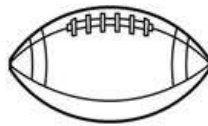
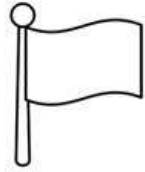
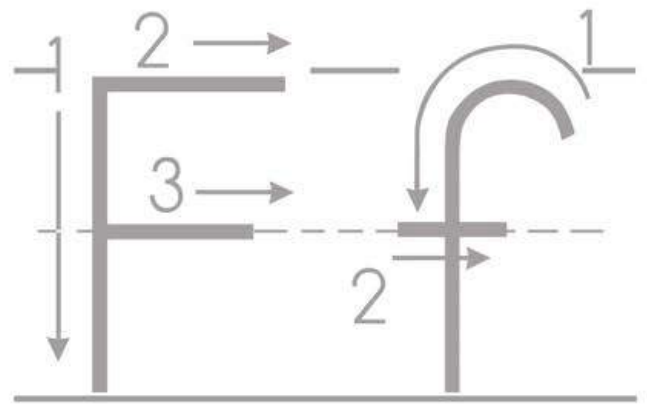

frog

flag

fire

football

fan

fairy

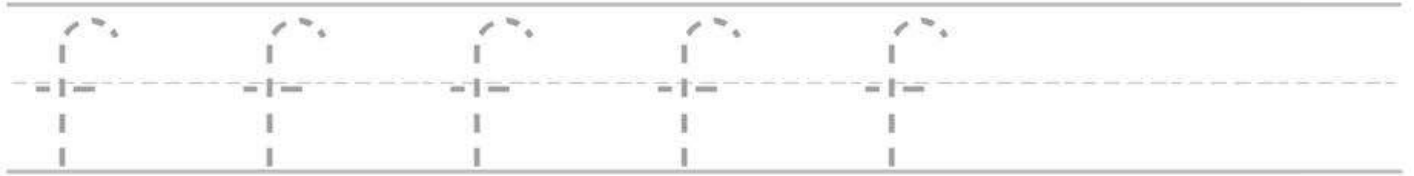
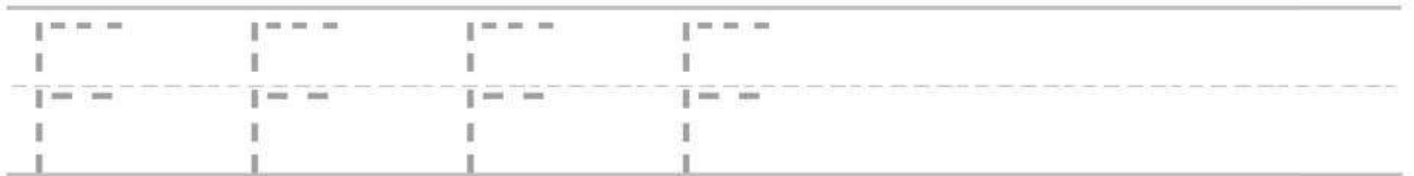
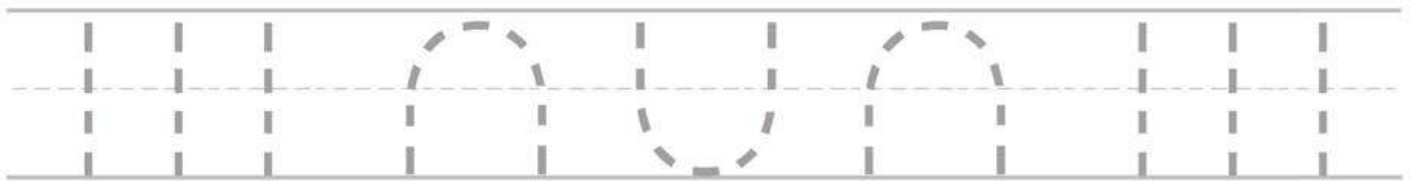

Draw seven flies for the frog to feast on:



Measure:

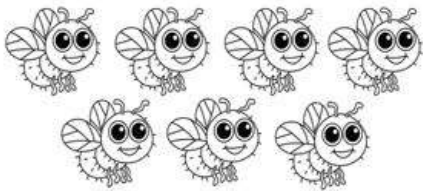
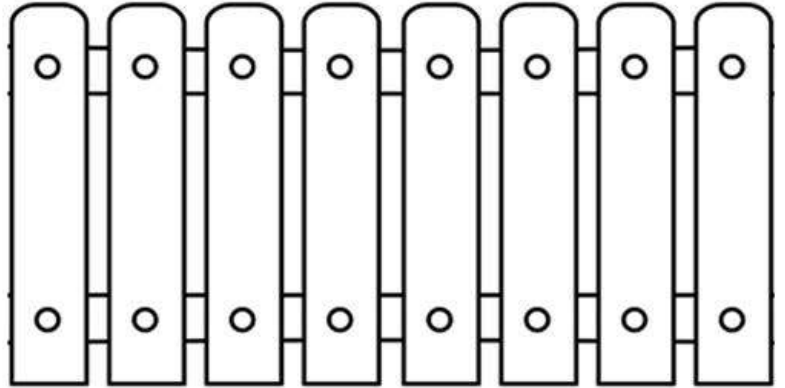

Add

+

=

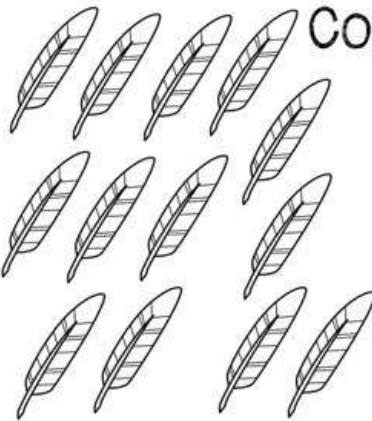

Count & Tally

$$7 + 1 = \square$$

$$1 + 7 = \square$$

$$\begin{array}{r} 2 \\ + 7 \\ \hline \square \end{array} \qquad \begin{array}{r} 7 \\ + 2 \\ \hline \square \end{array}$$

Circle what comes next:

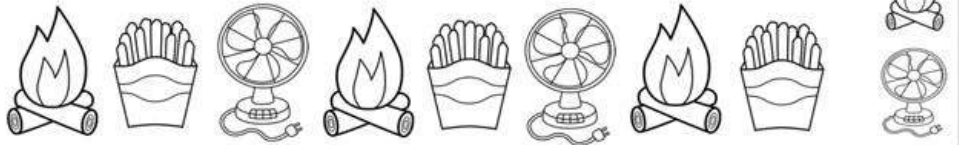

Circle the fourth football. Underline the fifth.



Draw: $7 + 1 = 8$

$$+ =$$

F f

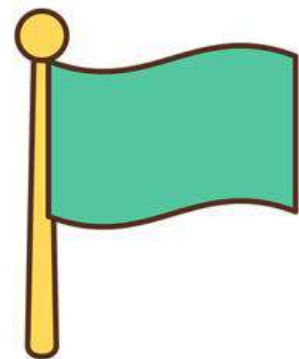
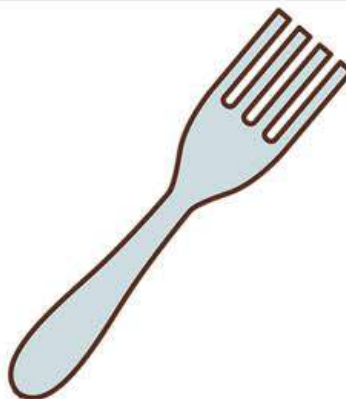
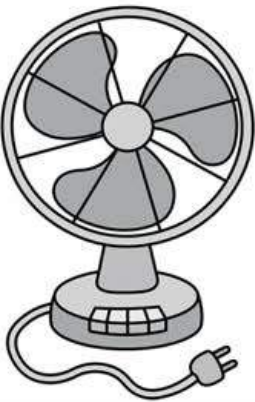
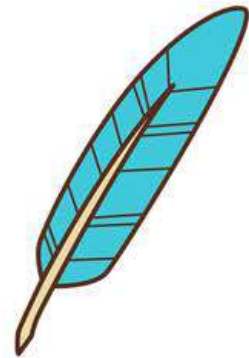
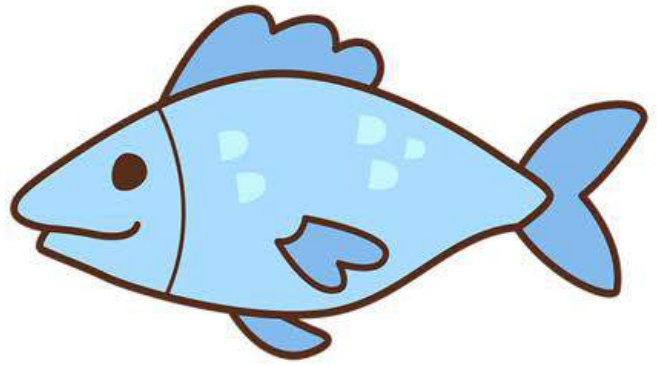

I CAN COLOR

words with:

-  = feather
-  = fire
-  = football
-  = frog
-  = fish
-  = fairy
-  = fan
-  = fork

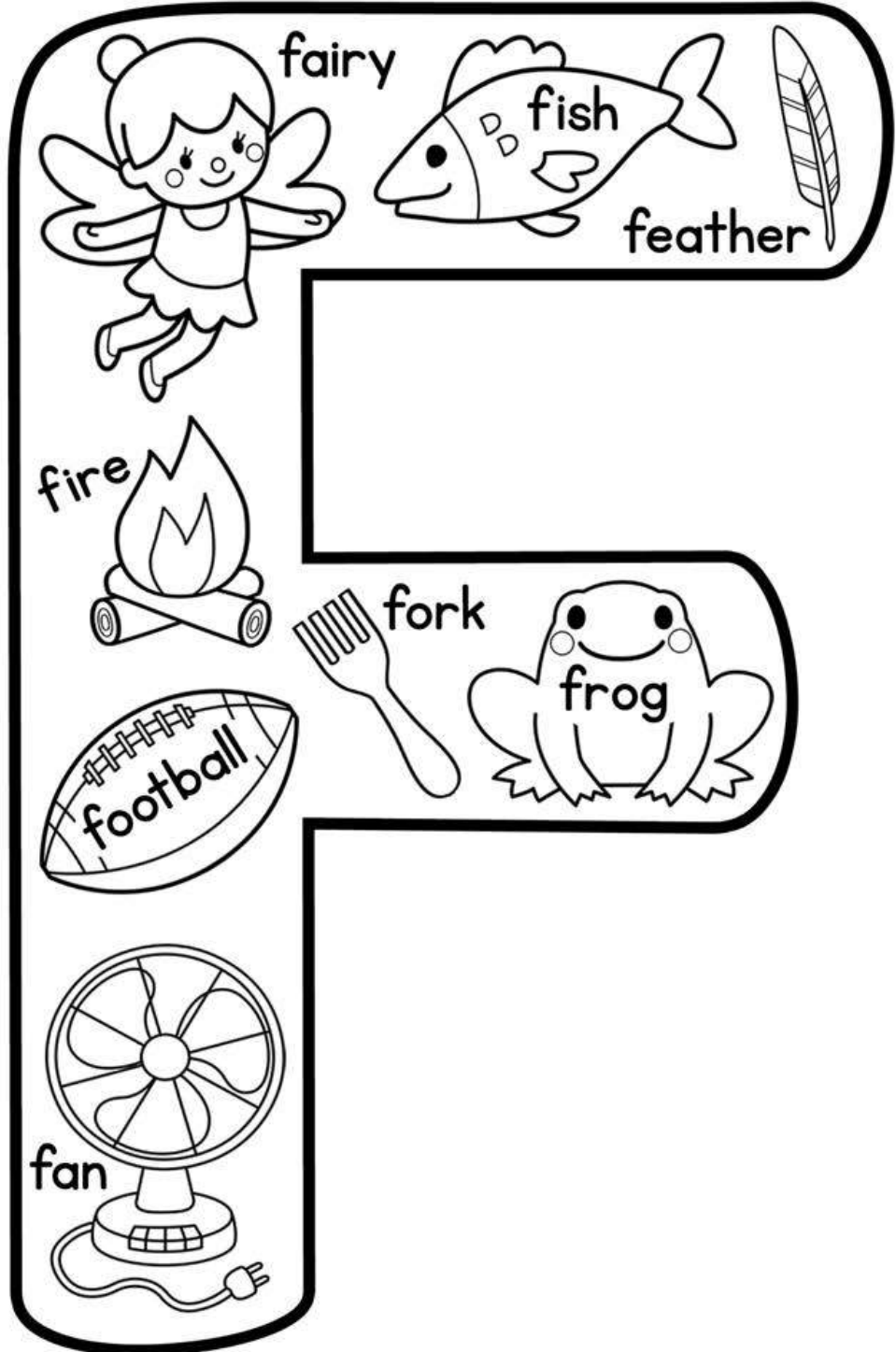

NAME : _____

Ff

Write and read words that begin with letter f.

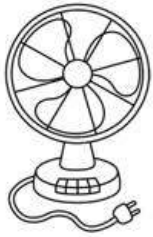

fan fan fan

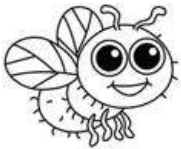

fly fly fly



frog frog



fork fork

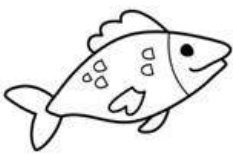

fish fish



fire fire

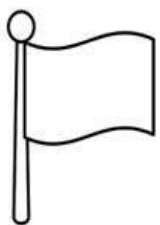

flag flag

NAME : _____

Ff

Write and read words that begin with letter f.

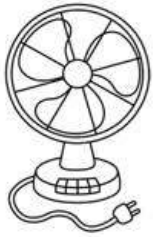

Fan Fan Fan

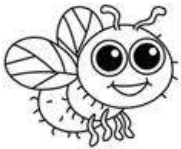

Fly Fly Fly



Frog Frog



Fork Fork

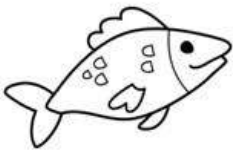

Fish Fish



Fire Fire

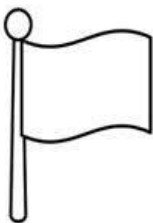

Flag Flag

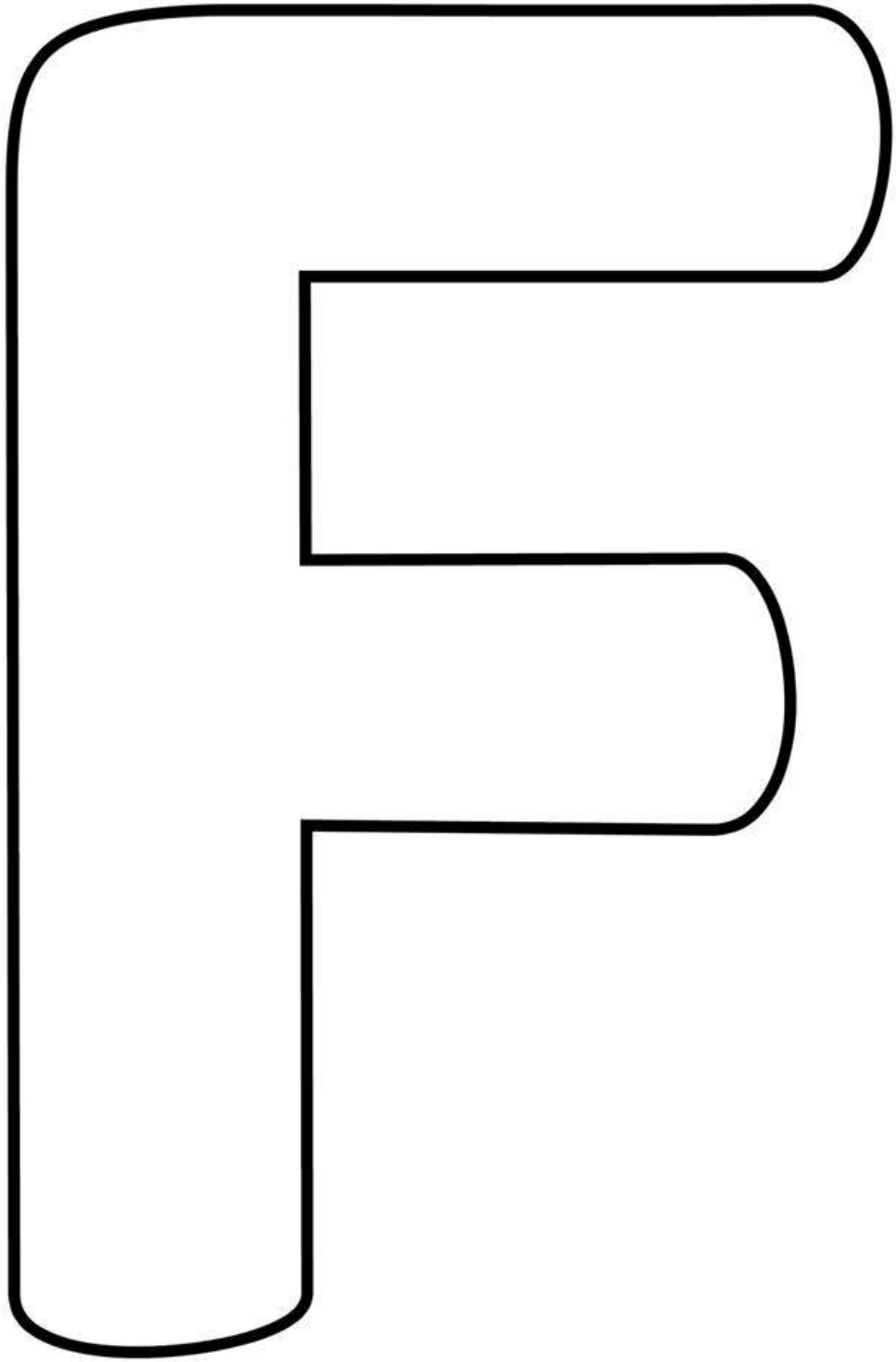

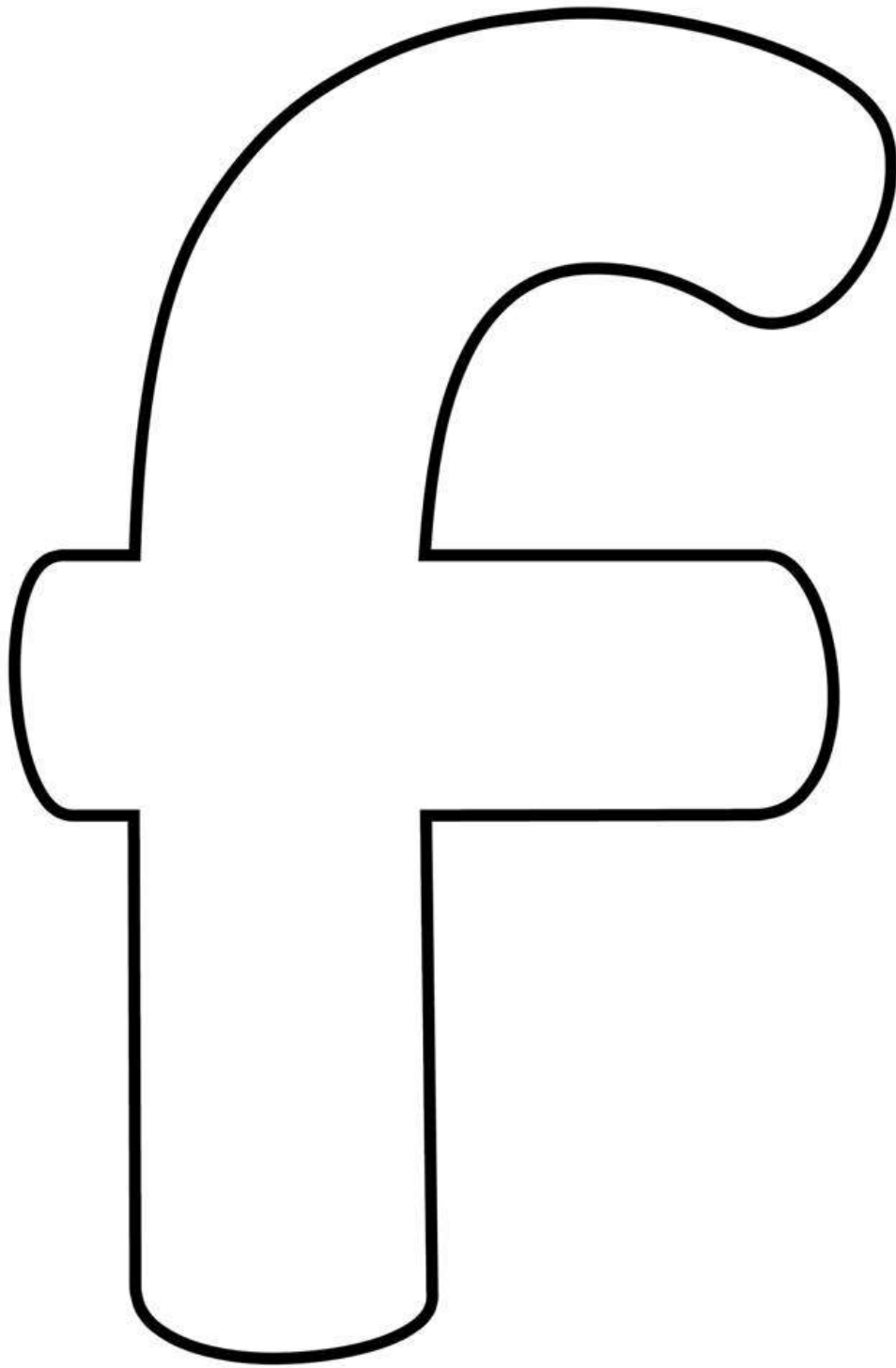

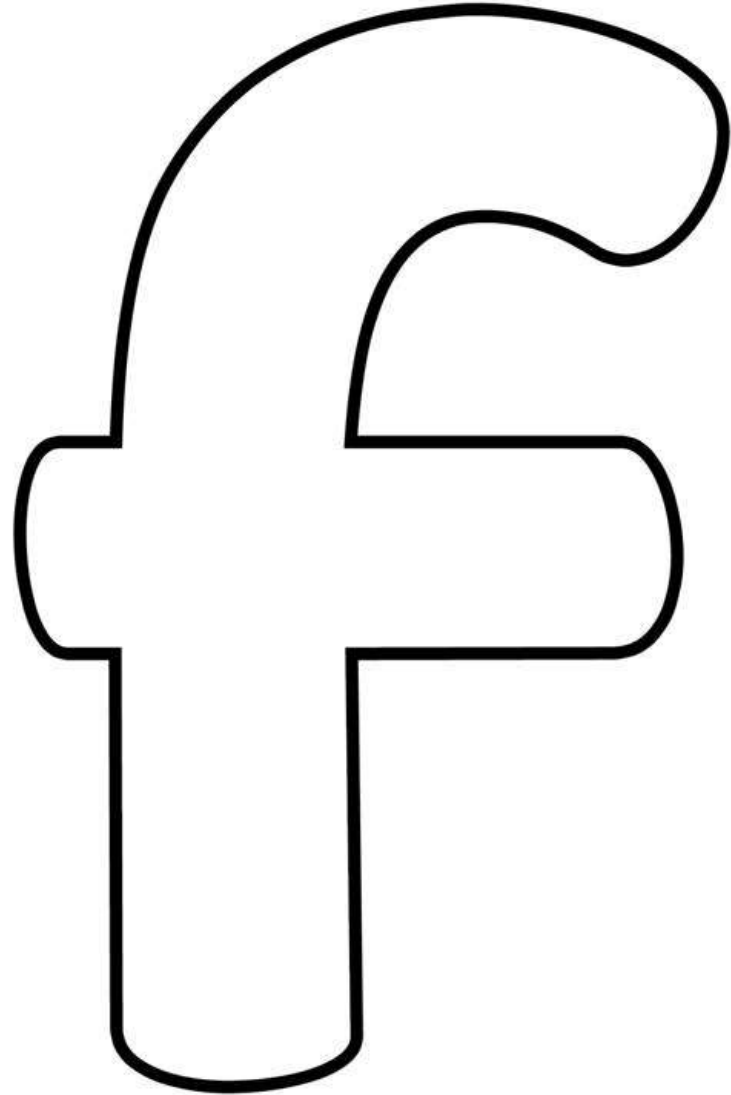
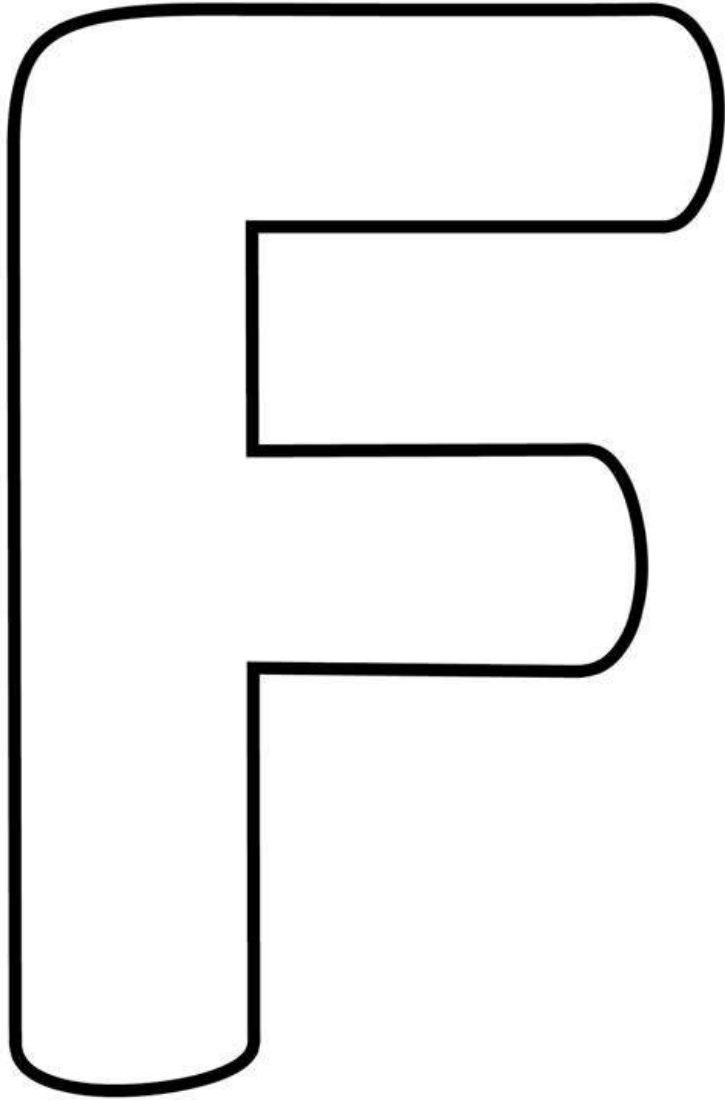

I C A N

F I N D

the letter:

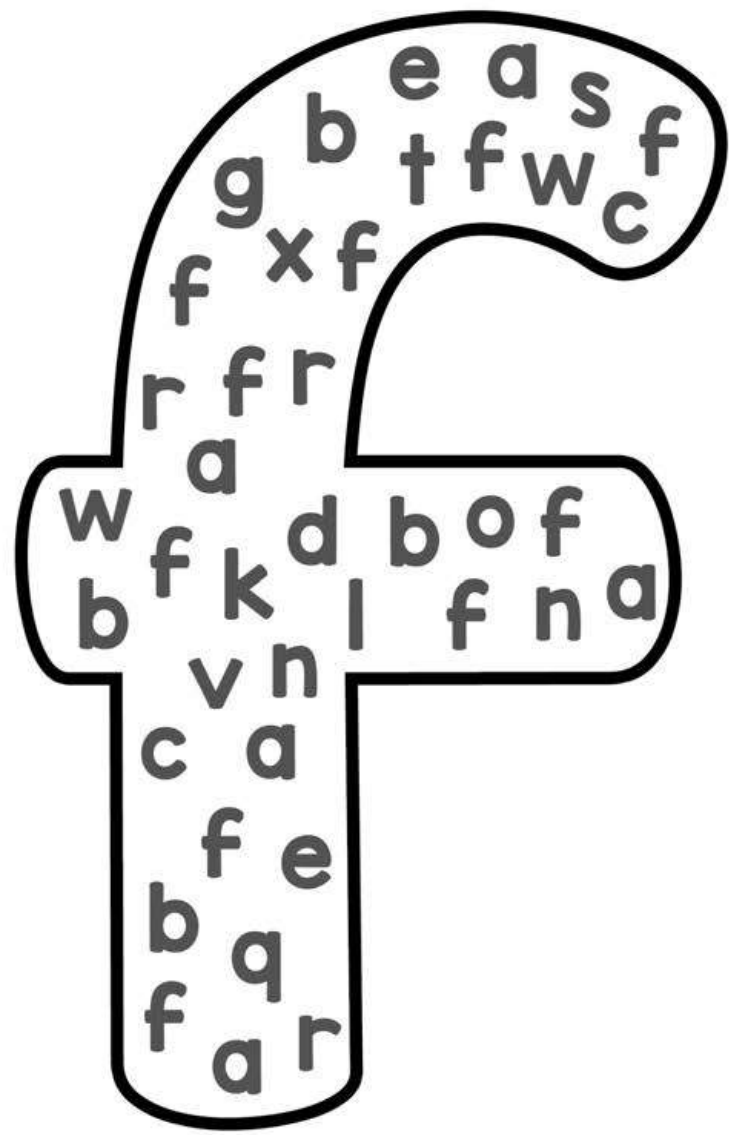
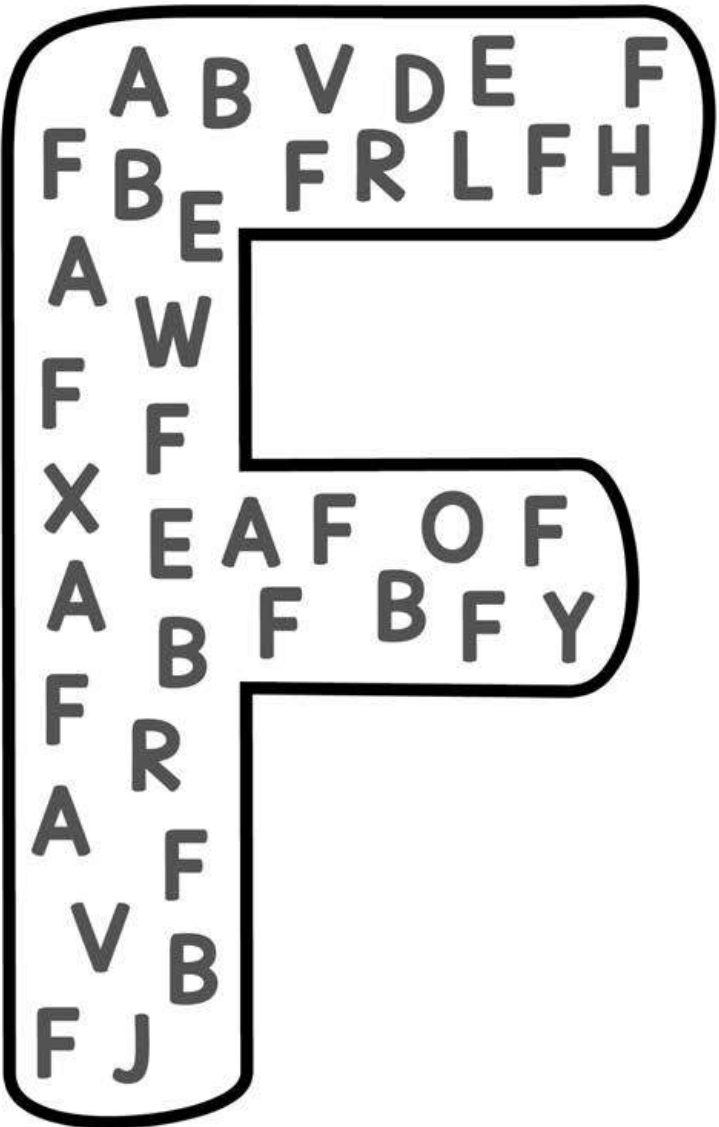

How Many?

How Many?

NAME : _____

TRACE



Color one for each row of letters you complete

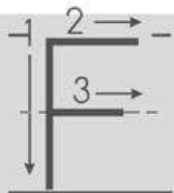

F F F F F F

F F F F F F F F

F F F F F F F F

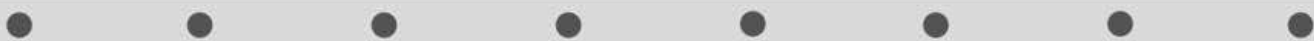

f f f f f f f f

f f f f f f f f



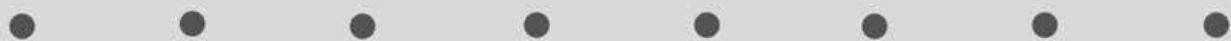

f f f f f f f f

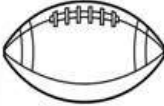
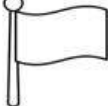

C · O · U · N · T ·

F f F f F f F f F f F f

G · R · A · P · H ·

F	f					

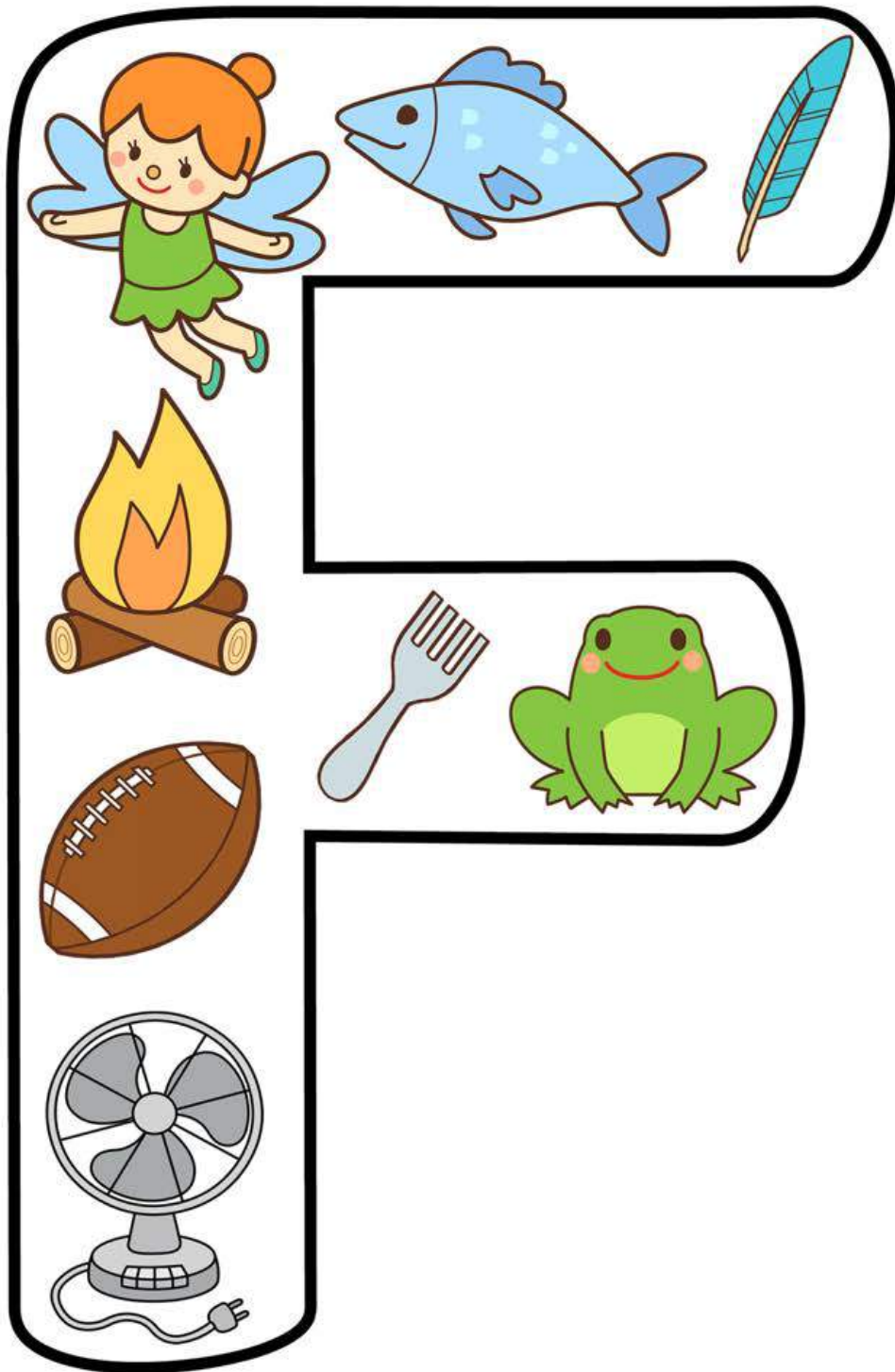

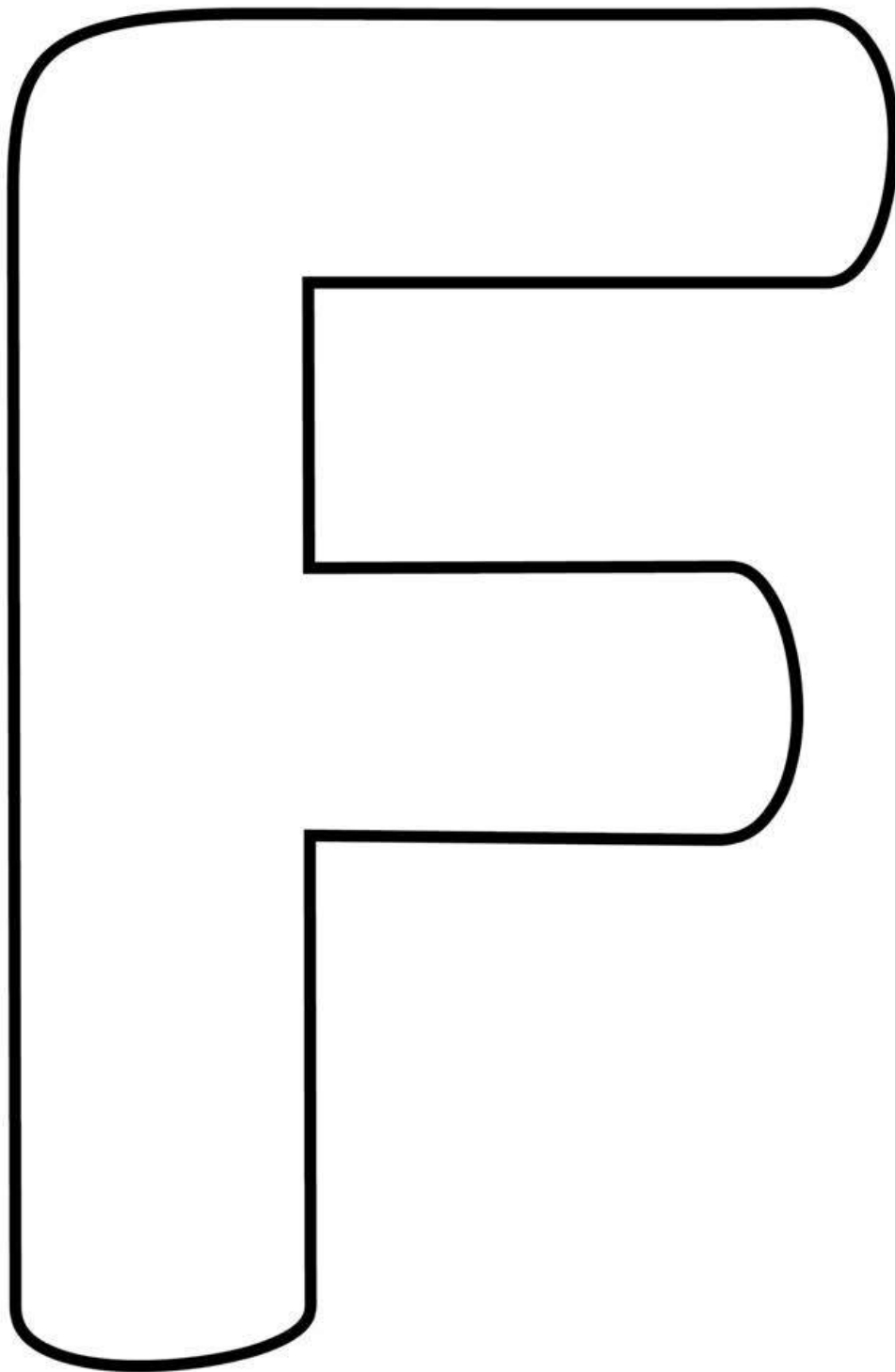

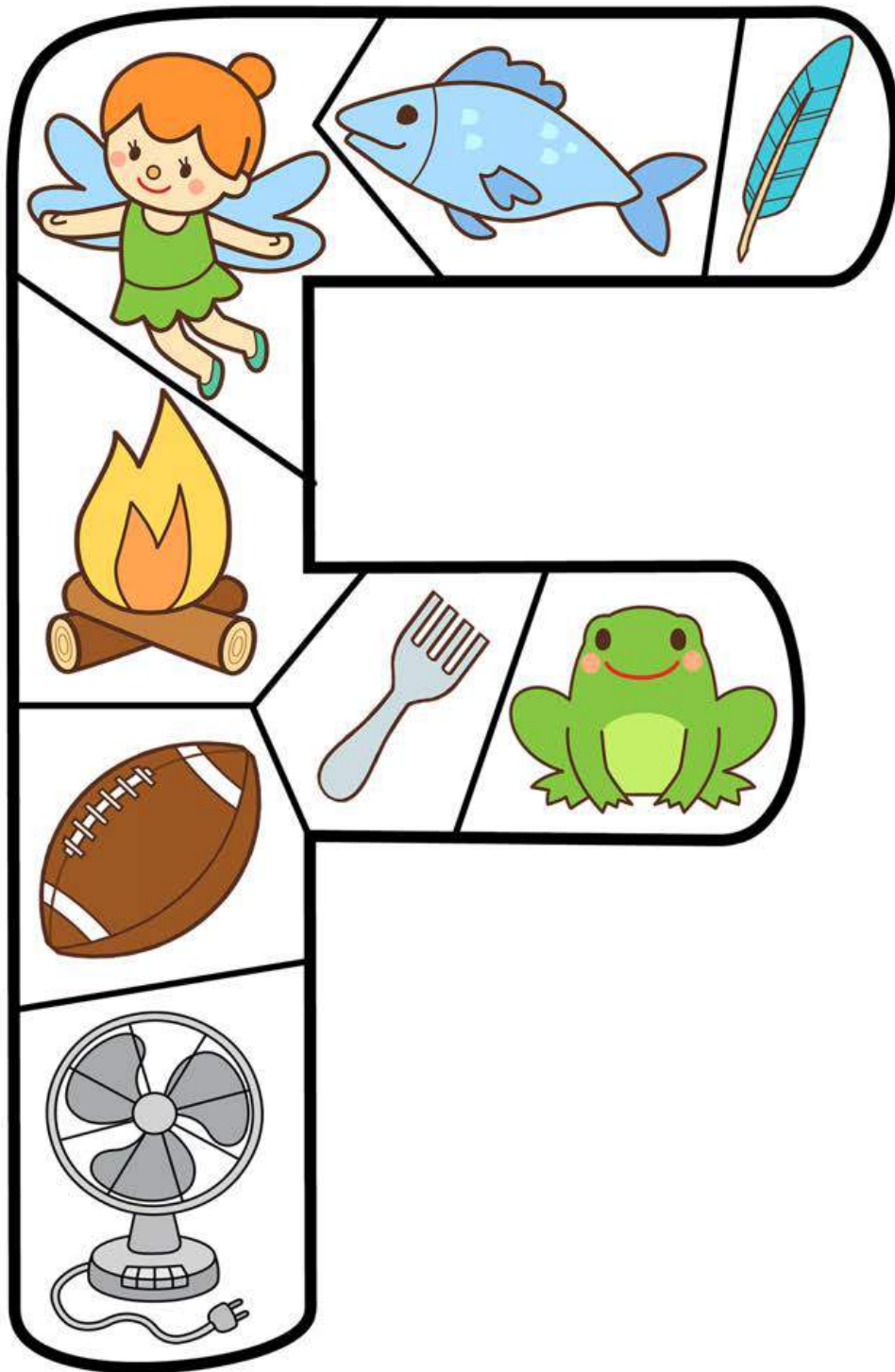

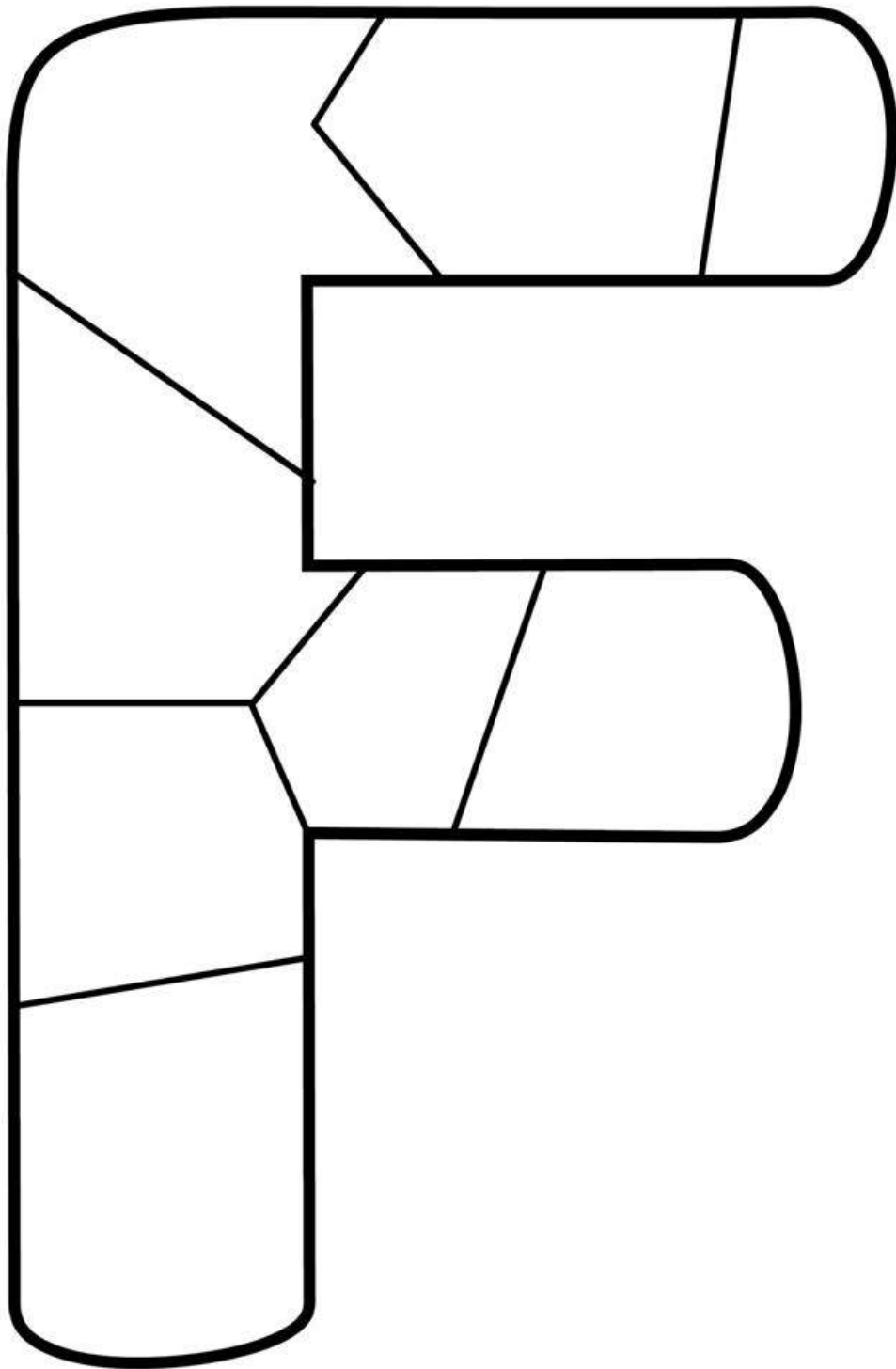

1. Write

2. Cut Out 

NAME : _____

Q	U
Q	U
q	q
q	q
Q	q

A B C Q U I L T

3. Color

4. Cut out 

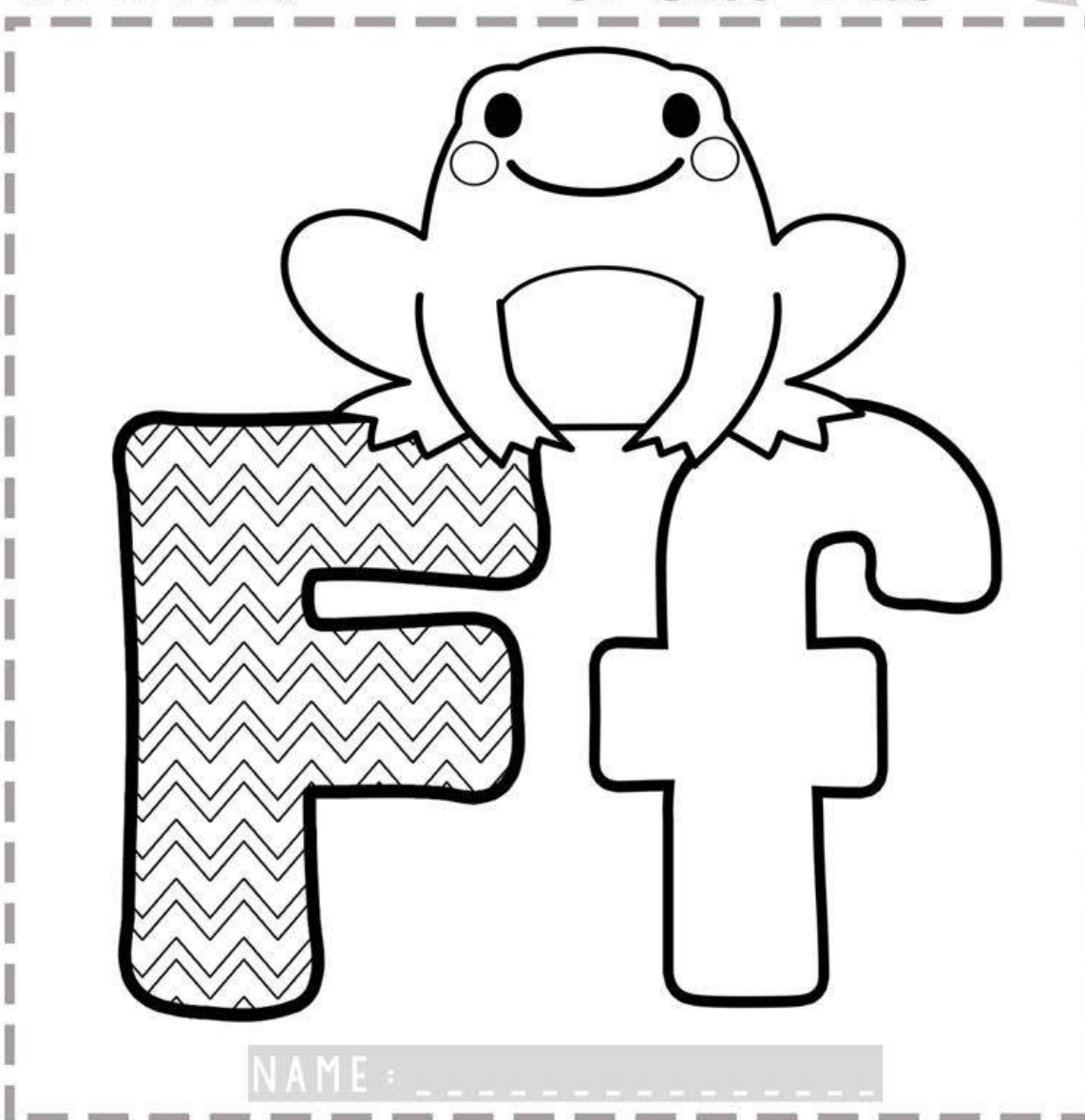

NAME : _____

Ff

Write and read words that begin with letter f.

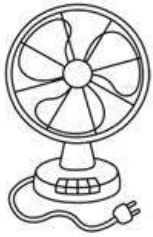

fan fan fan



fly fly fly



frog frog



fork fork

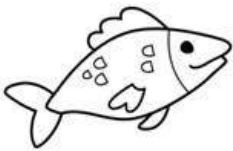

fish fish



fire fire

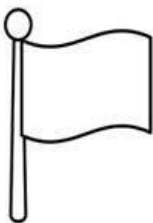

flag flag

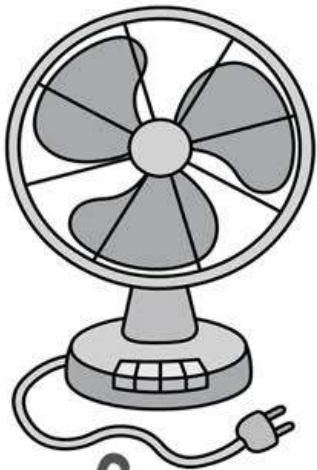

fan

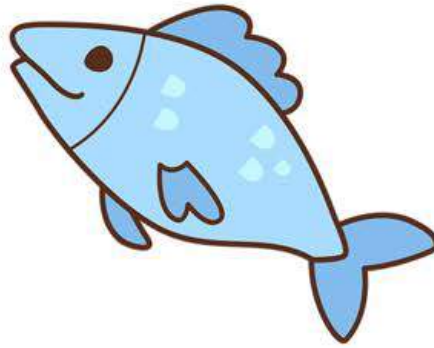

fish



fairy



fire

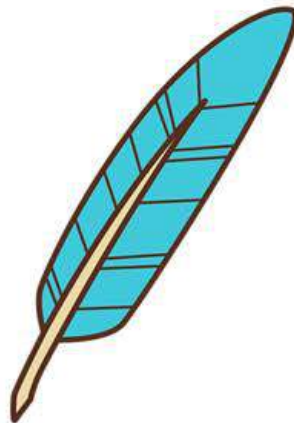

feather

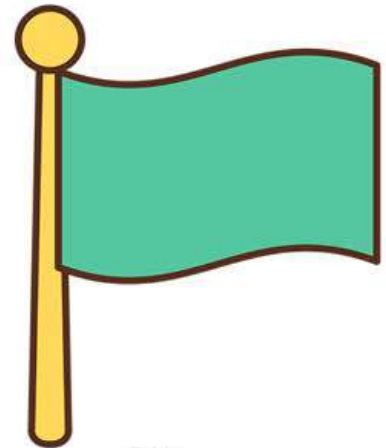

flag



frog



football

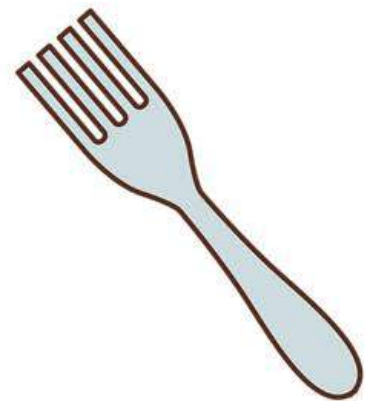



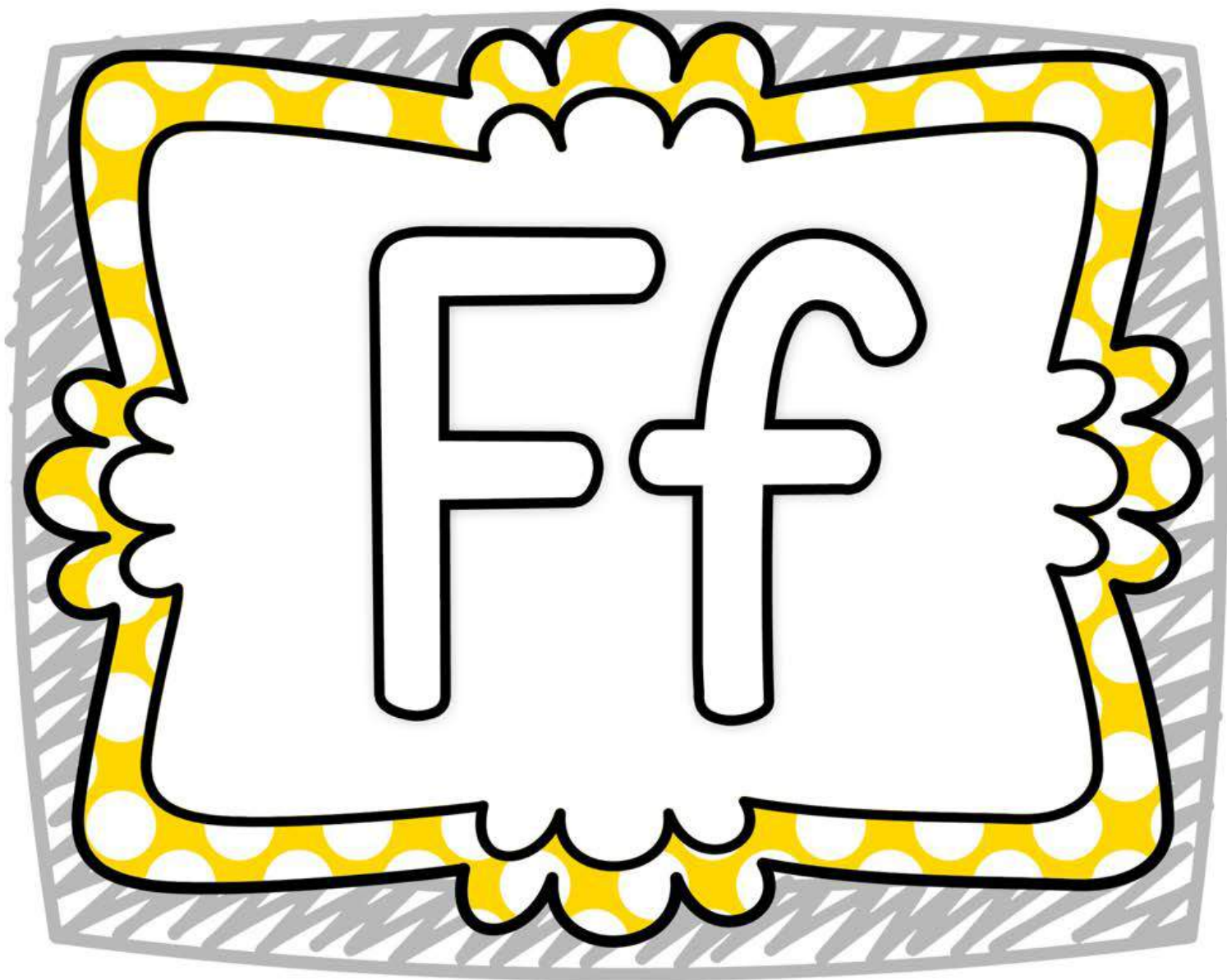











fork



LETTER F





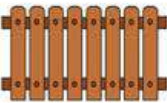









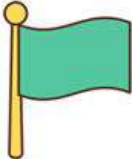

4 IN A ROW

LETTER F













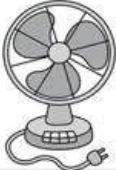



4 IN A ROW

LETTER F







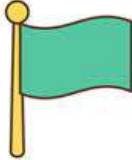









4 IN A ROW

LETTER F



4 IN A ROW

I C A N W R I T E

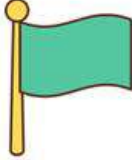

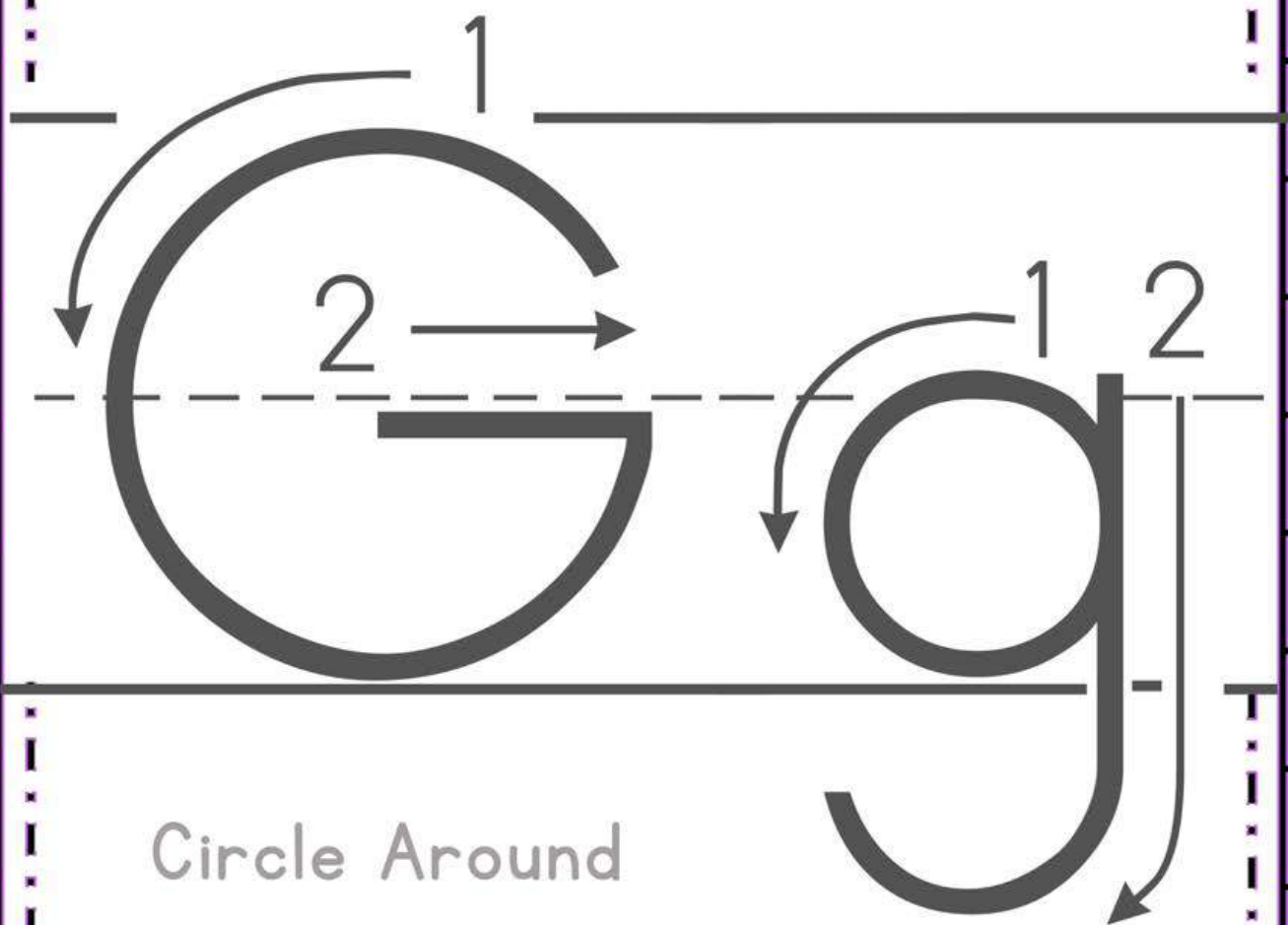
Circle Around

Pick up

Over

Circle Around

Pick up

Down with a

Tail

Giraffe



G g

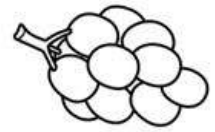
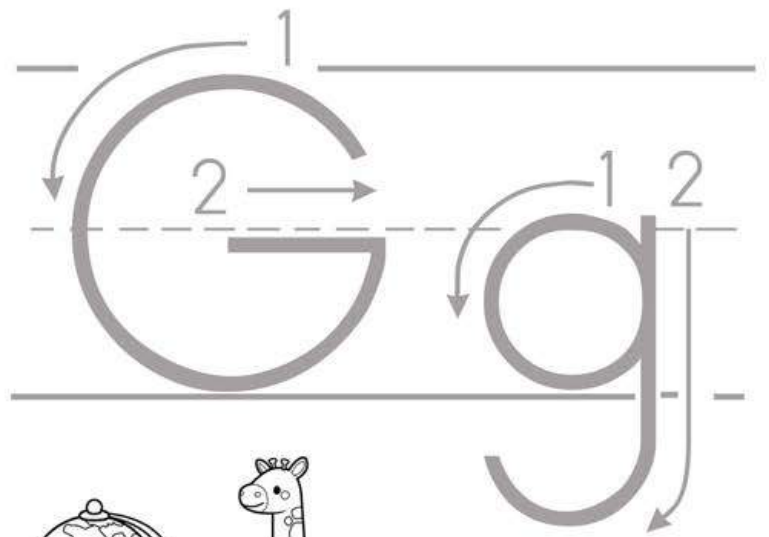

glasses gift glove globe giraffe grapes

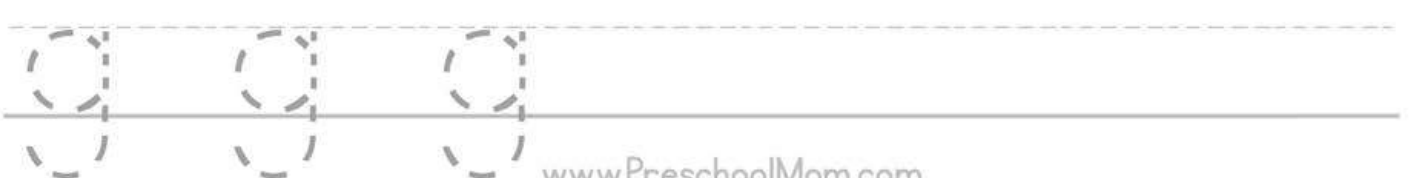
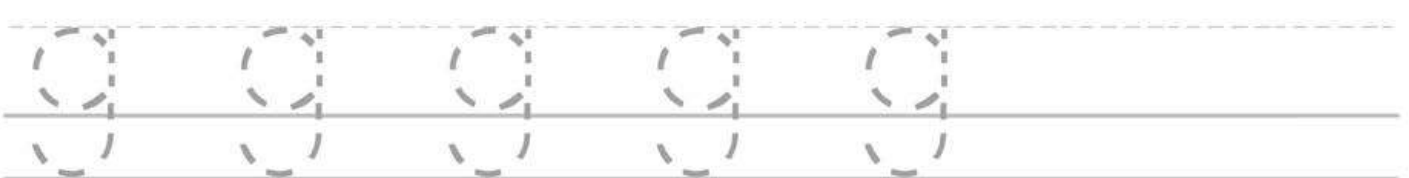
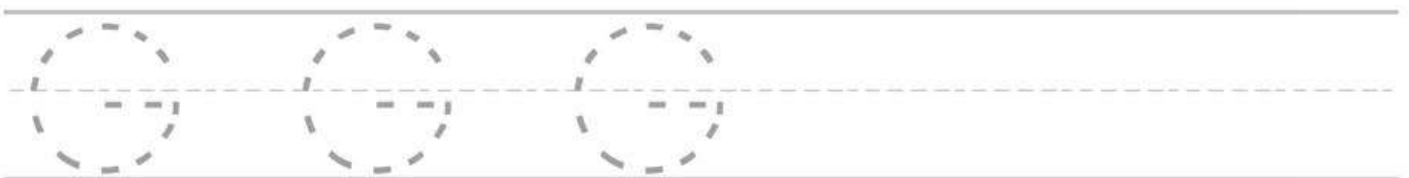
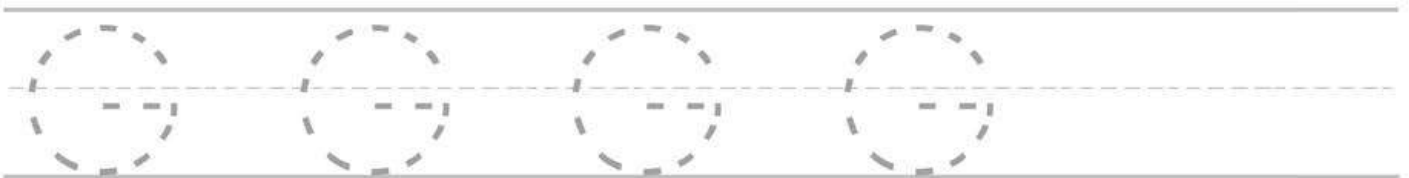
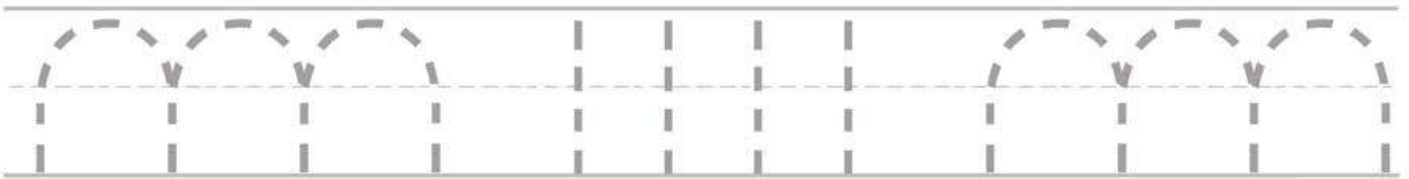

Trace the gemstones:



Measure:

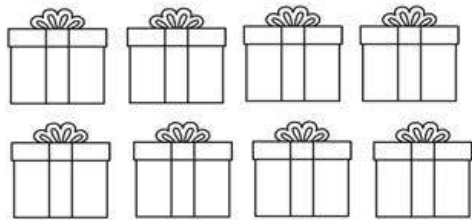
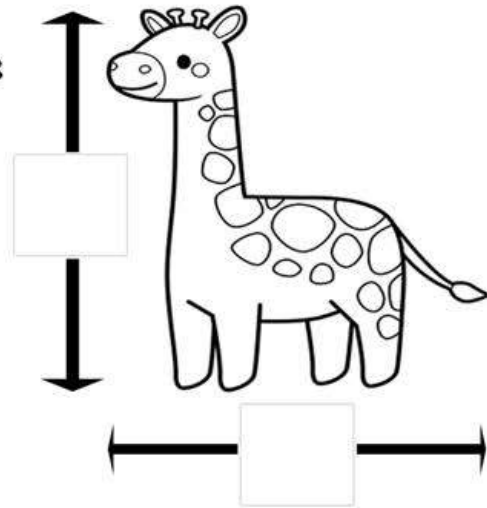

Add

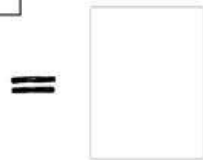
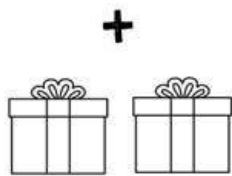

Count & Tally the fingers:

$$8 + 1 = \square$$

$$8 + 2 = \square$$

$$\begin{array}{r} 2 \\ + 8 \\ \hline \square \end{array}$$

$$\begin{array}{r} 8 \\ + 2 \\ \hline \square \end{array}$$

Circle what comes next:



Give the 3rd ghost a hat & the fifth ghost a belt:



Draw: $8 + 2 = 10$

$$\begin{array}{r} 8 \\ + 2 \\ \hline \square \end{array} = \square$$



Gg

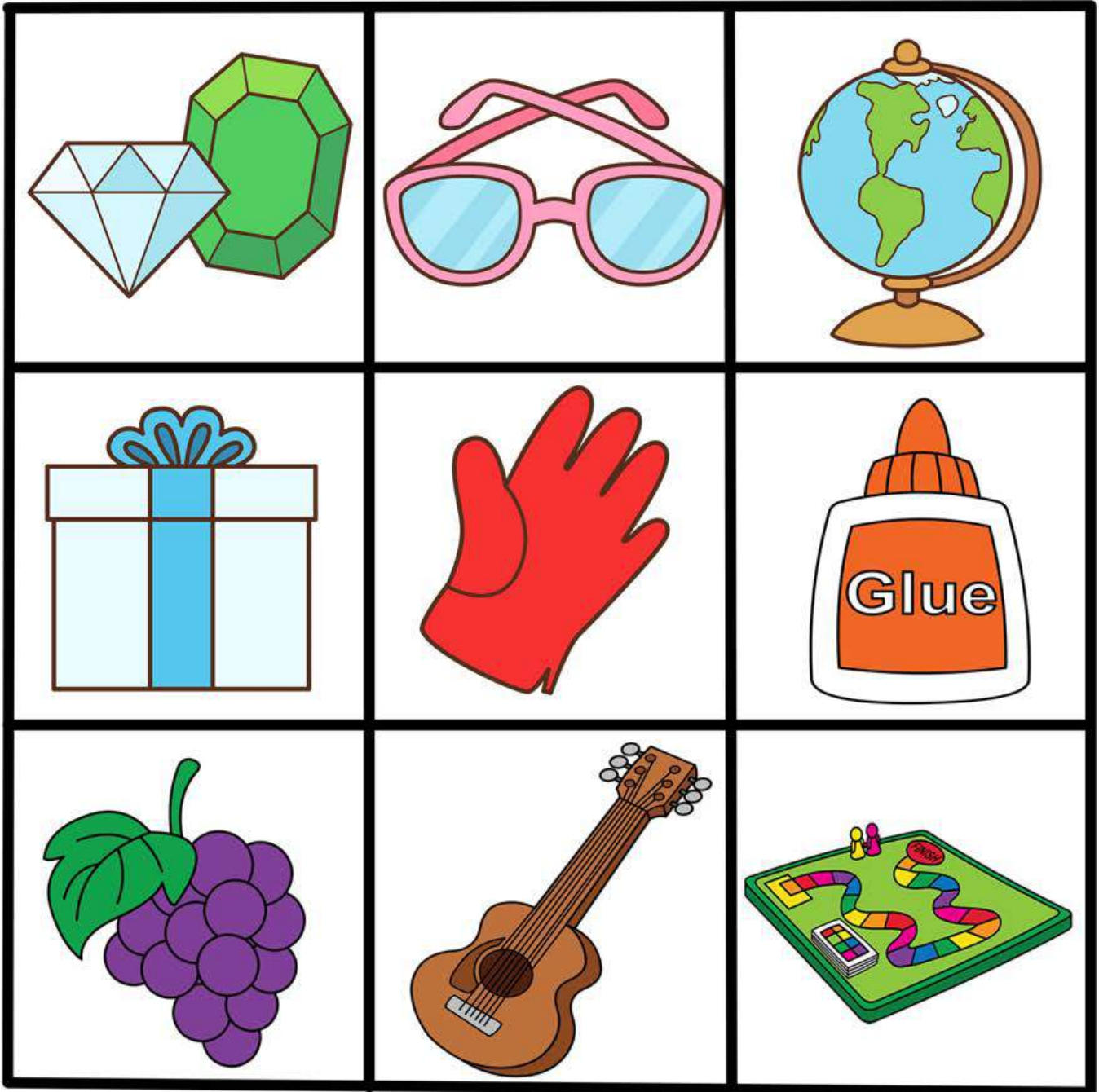

I CAN COLOR

words with:

● = gloves

● = guitar

● = glue

● = gems

● = globe

● = glasses

● = gift

● = gate

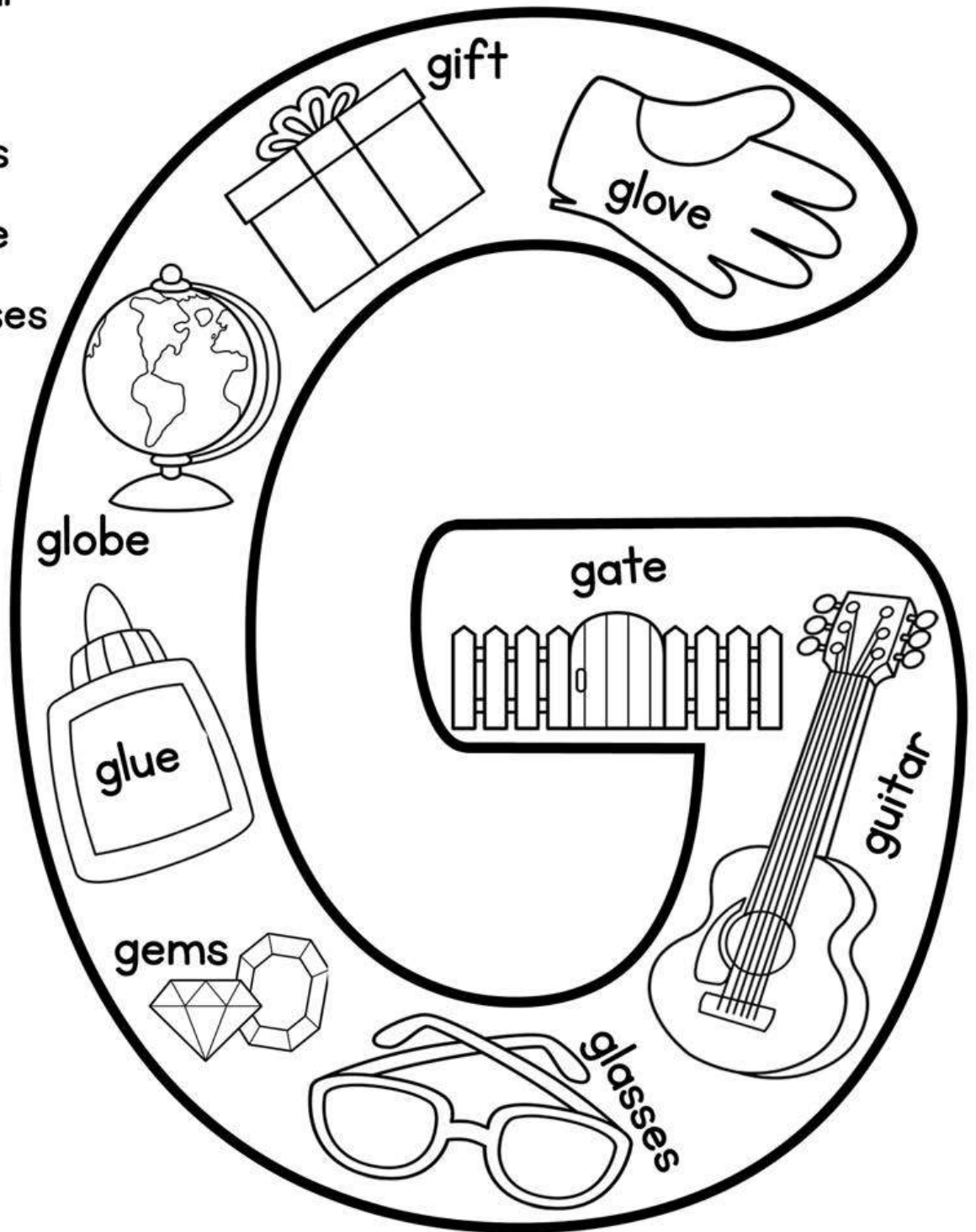

NAME : _____

Gg

Write and read words that begin with letter g.

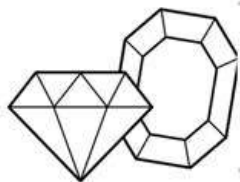

gem gem



gift gift

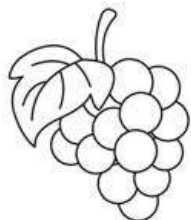

grape grape



glove glove



globe globe



game game

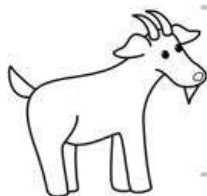

goat goat

NAME : _____

Gg

Write and read words that begin with letter g.

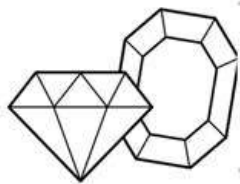

gem gem



gift gift

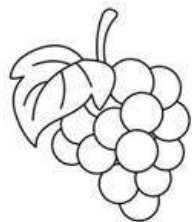

grape grape



glove glove



globe globe



game game

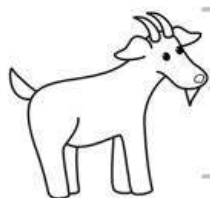

goat goat

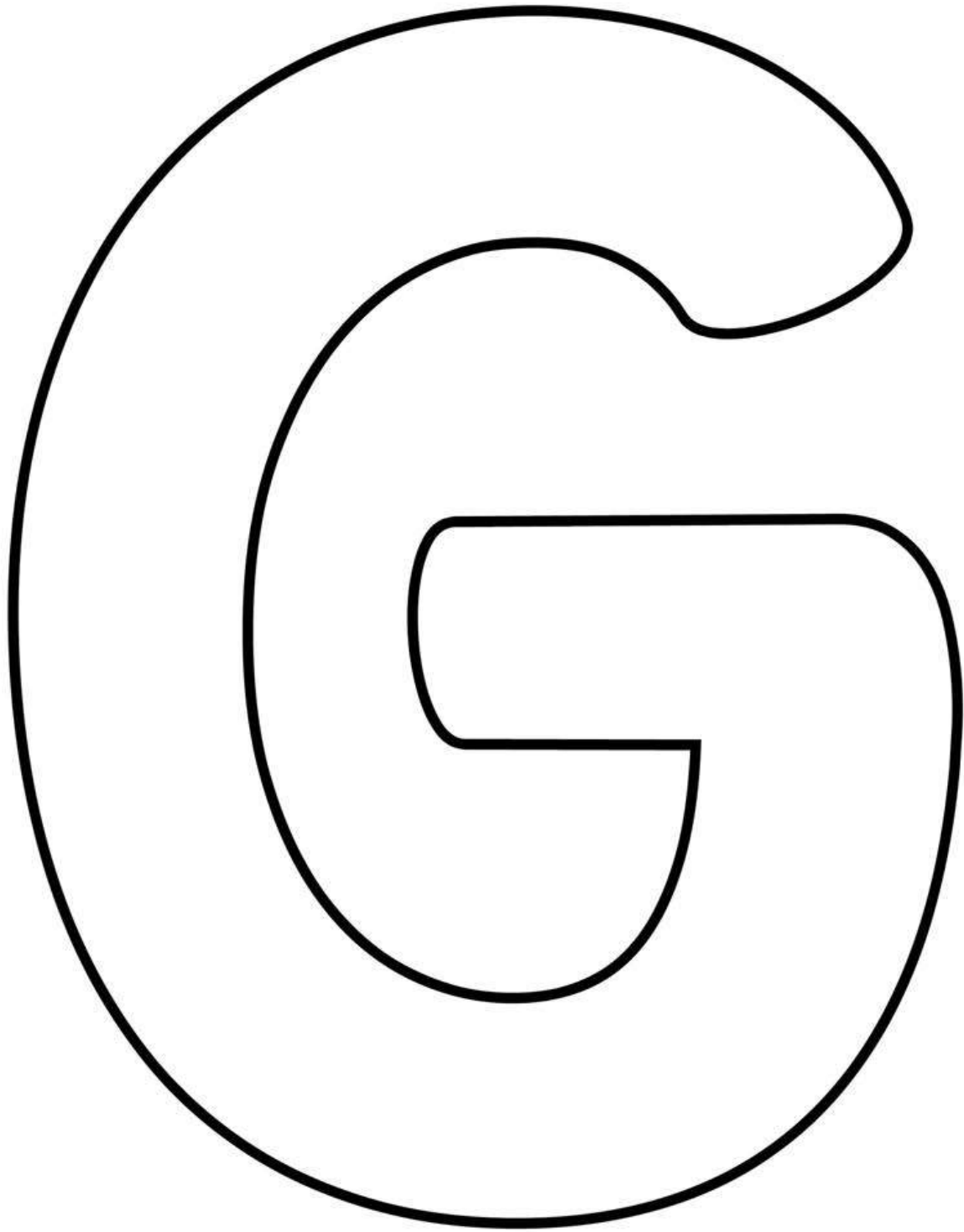

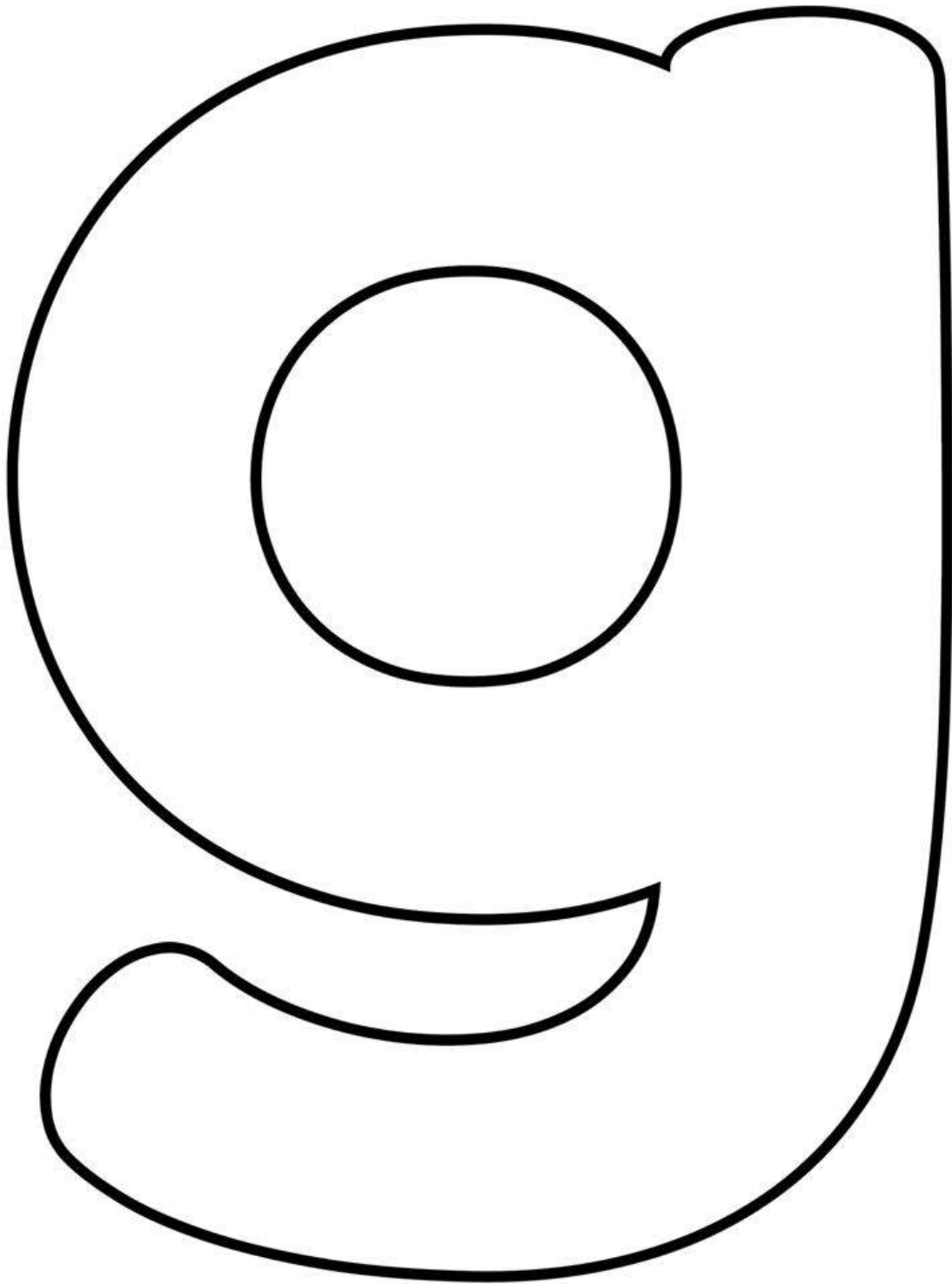

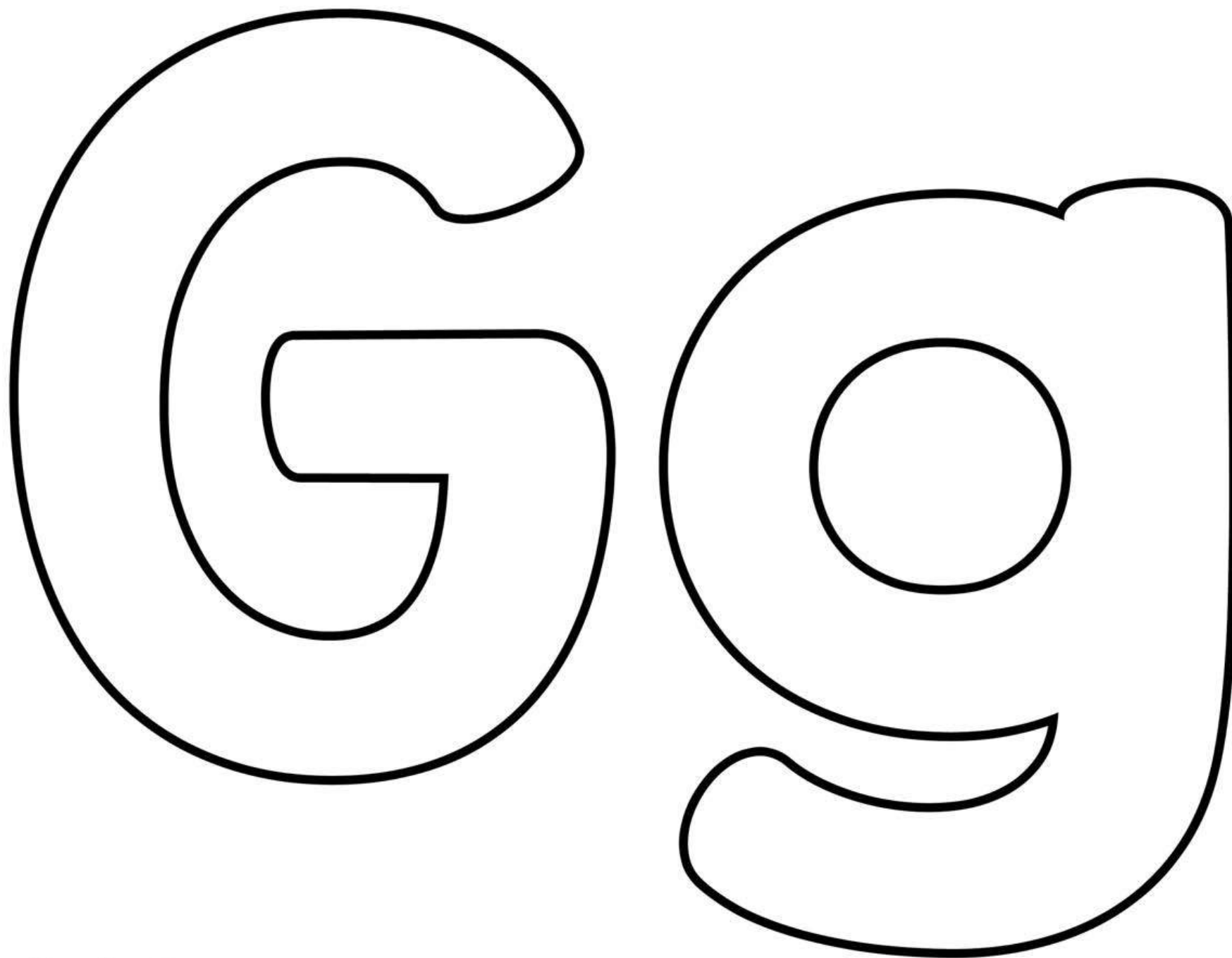

I C A N

F I N D

the letter:

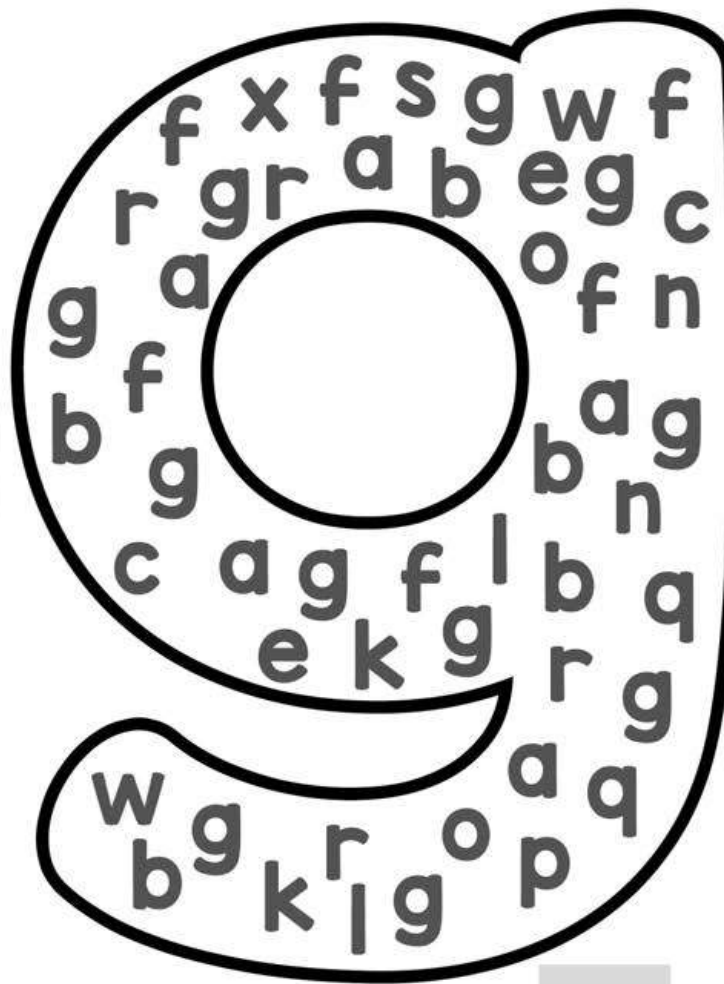
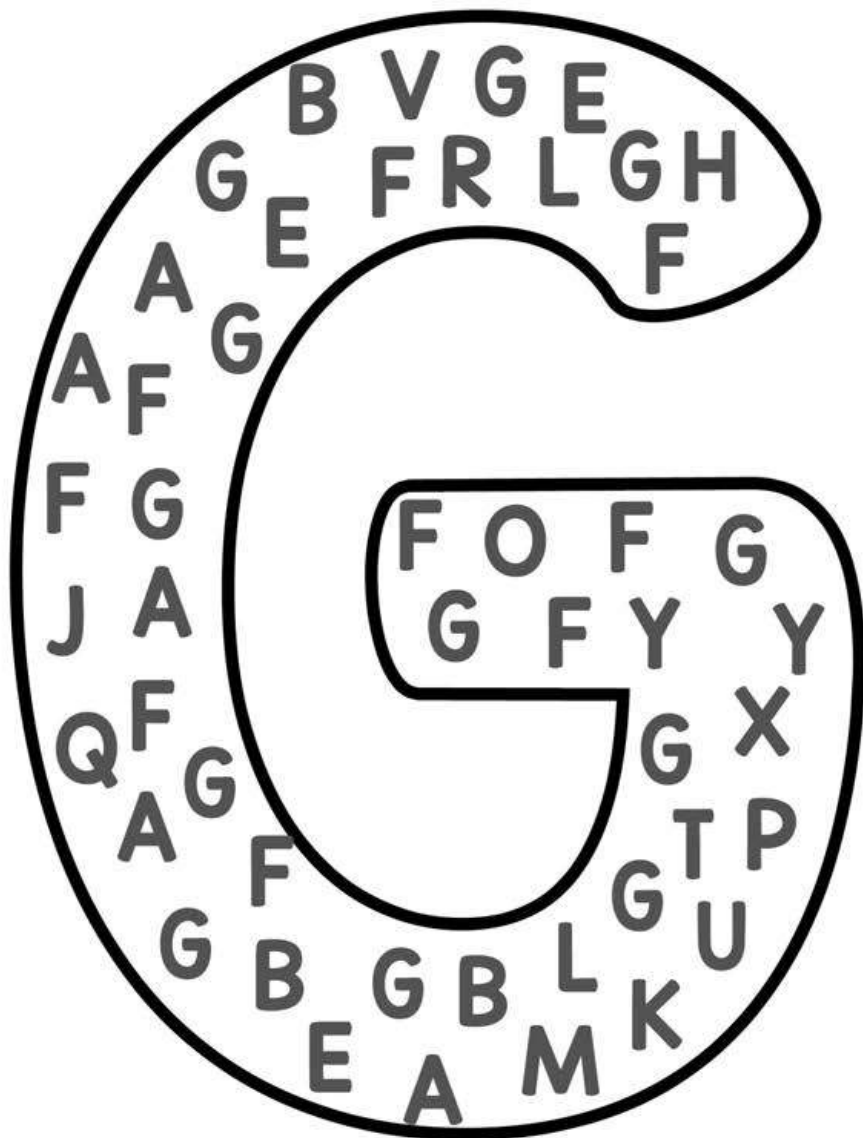

How Many?

How Many?

TRACE





NAME : _____

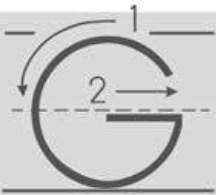



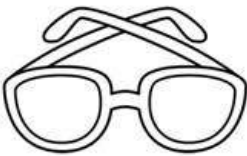



Color one for each row of letters you complete

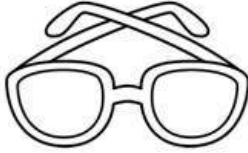





C · O · U · N · T

G   **g**   

    **G** **G**

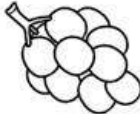
 **g**    **g**  **G**  

G · R · A · P · H

G	g					

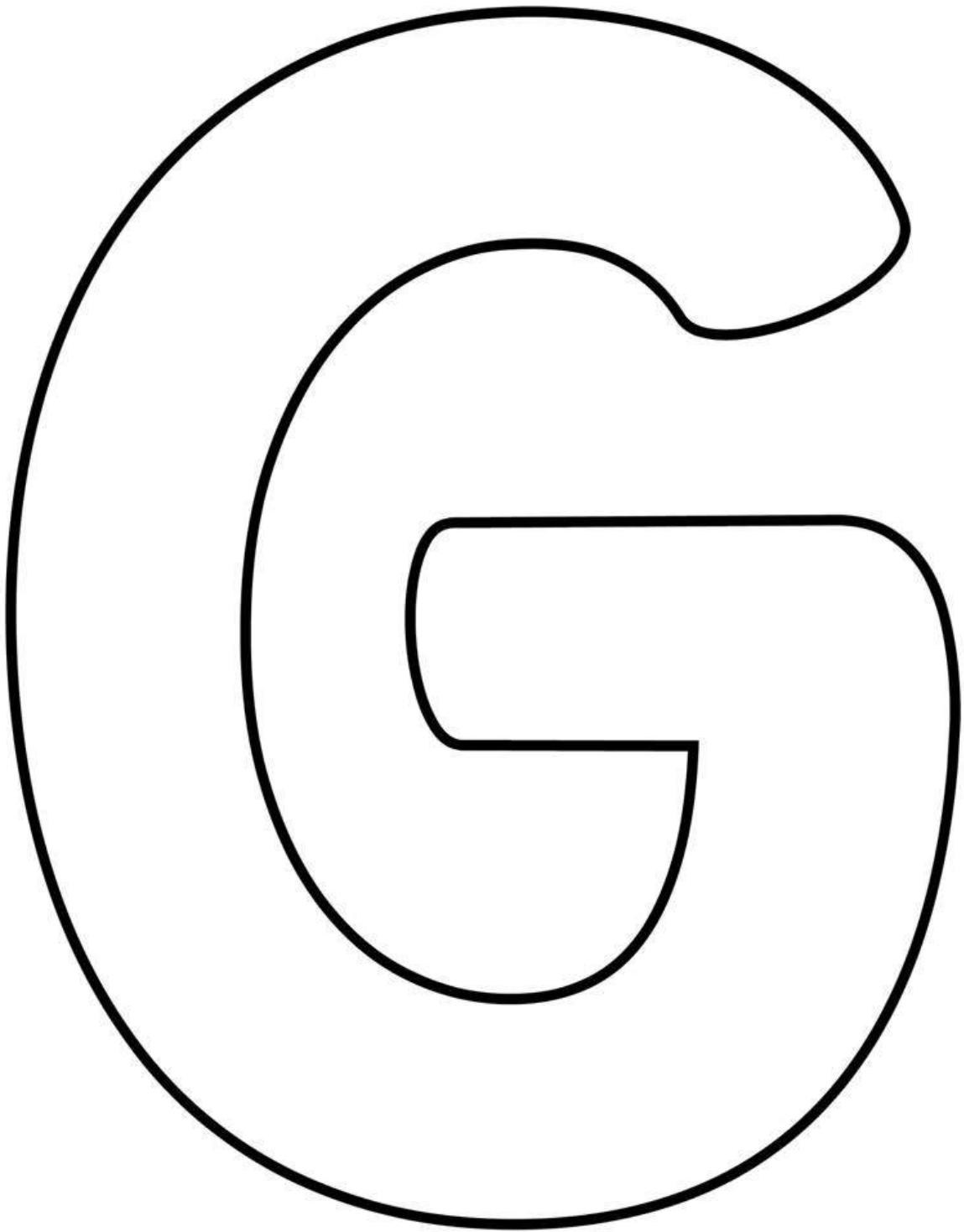

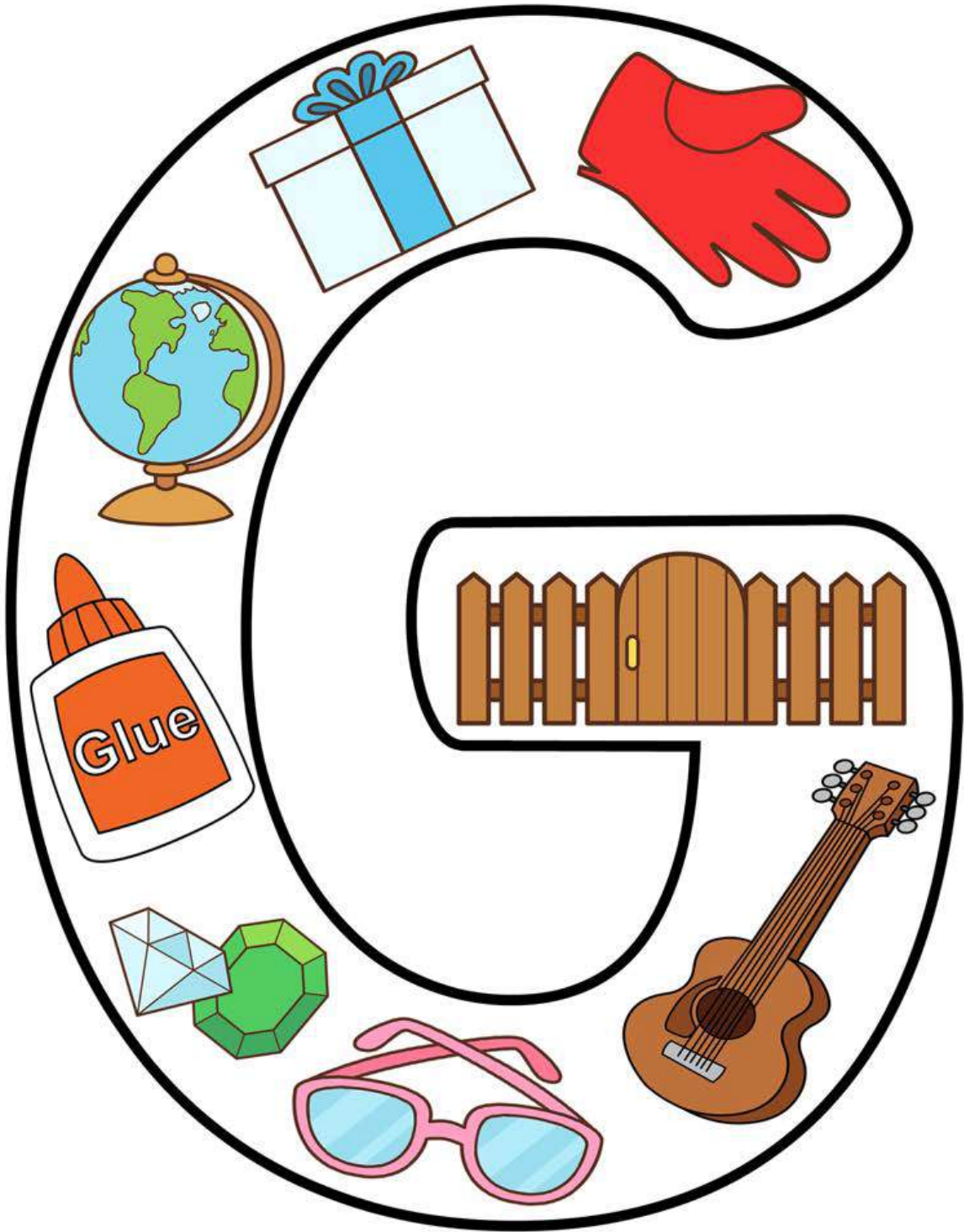

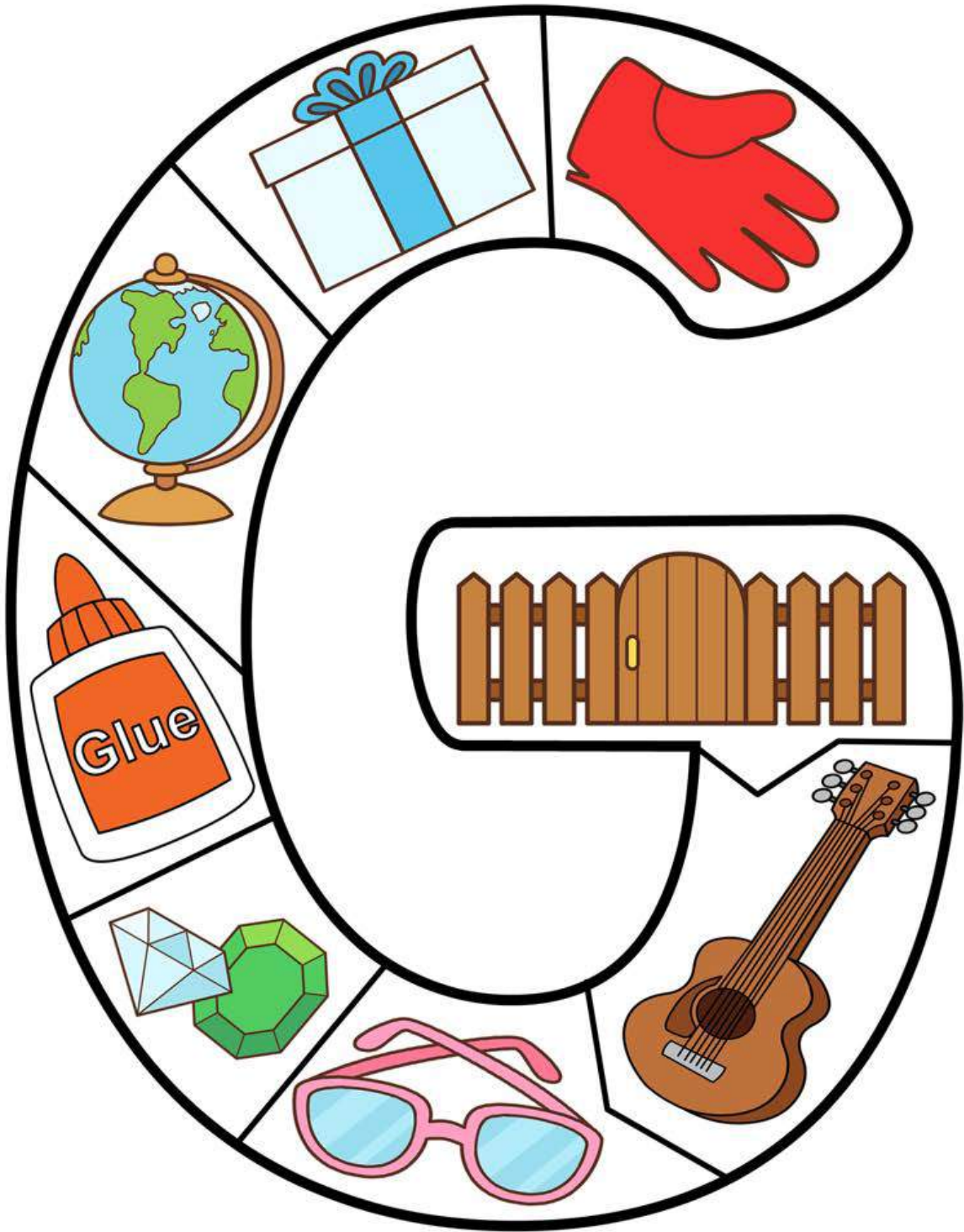

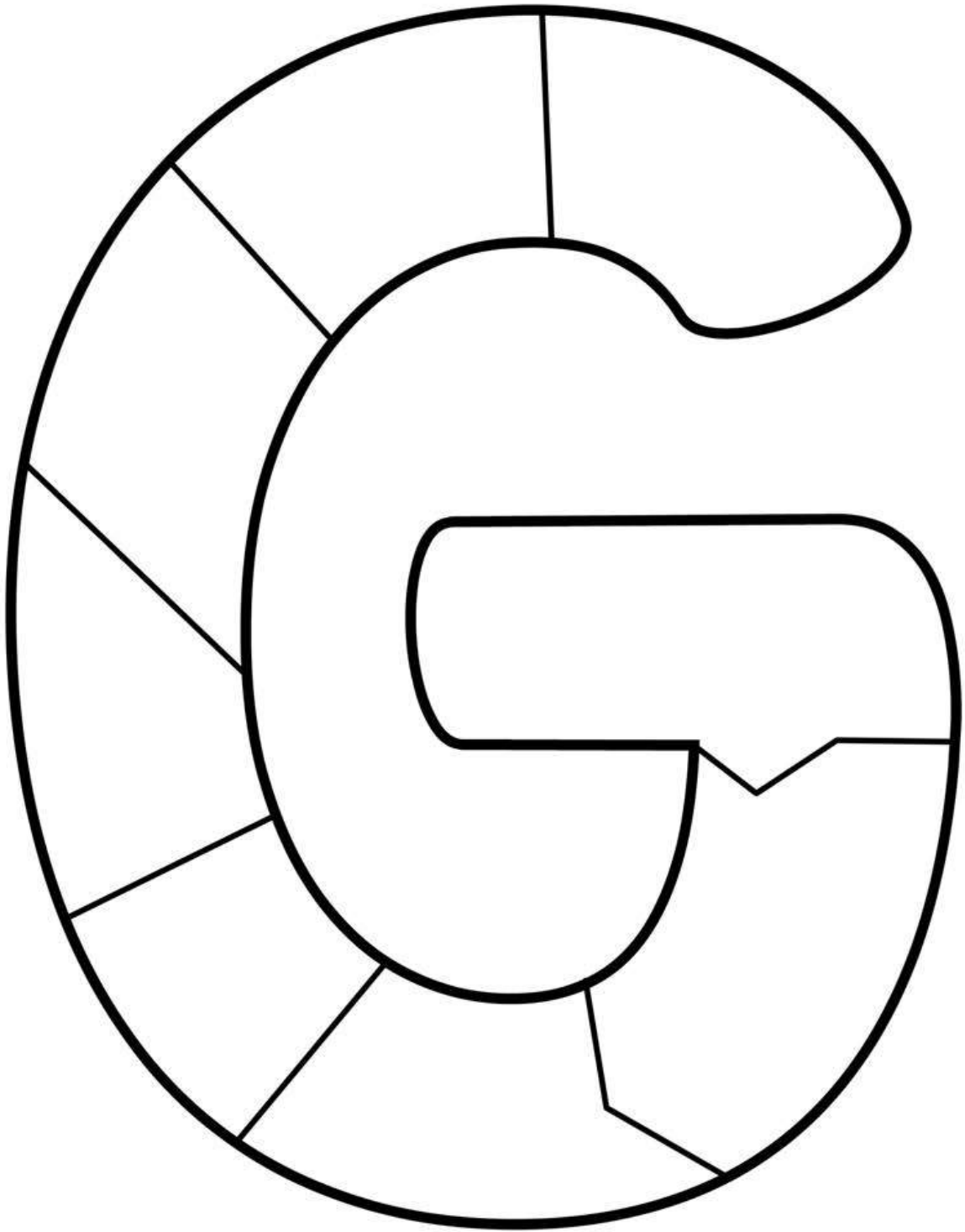



1. Write

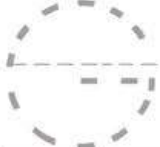
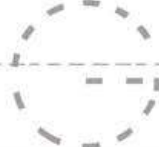

2. Cut Out 

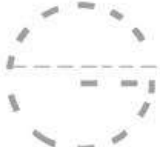
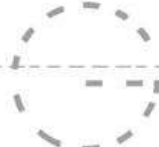

NAME : _____

 

A B C Q U I L T

3. Color

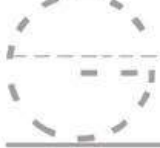
4. Cut out 

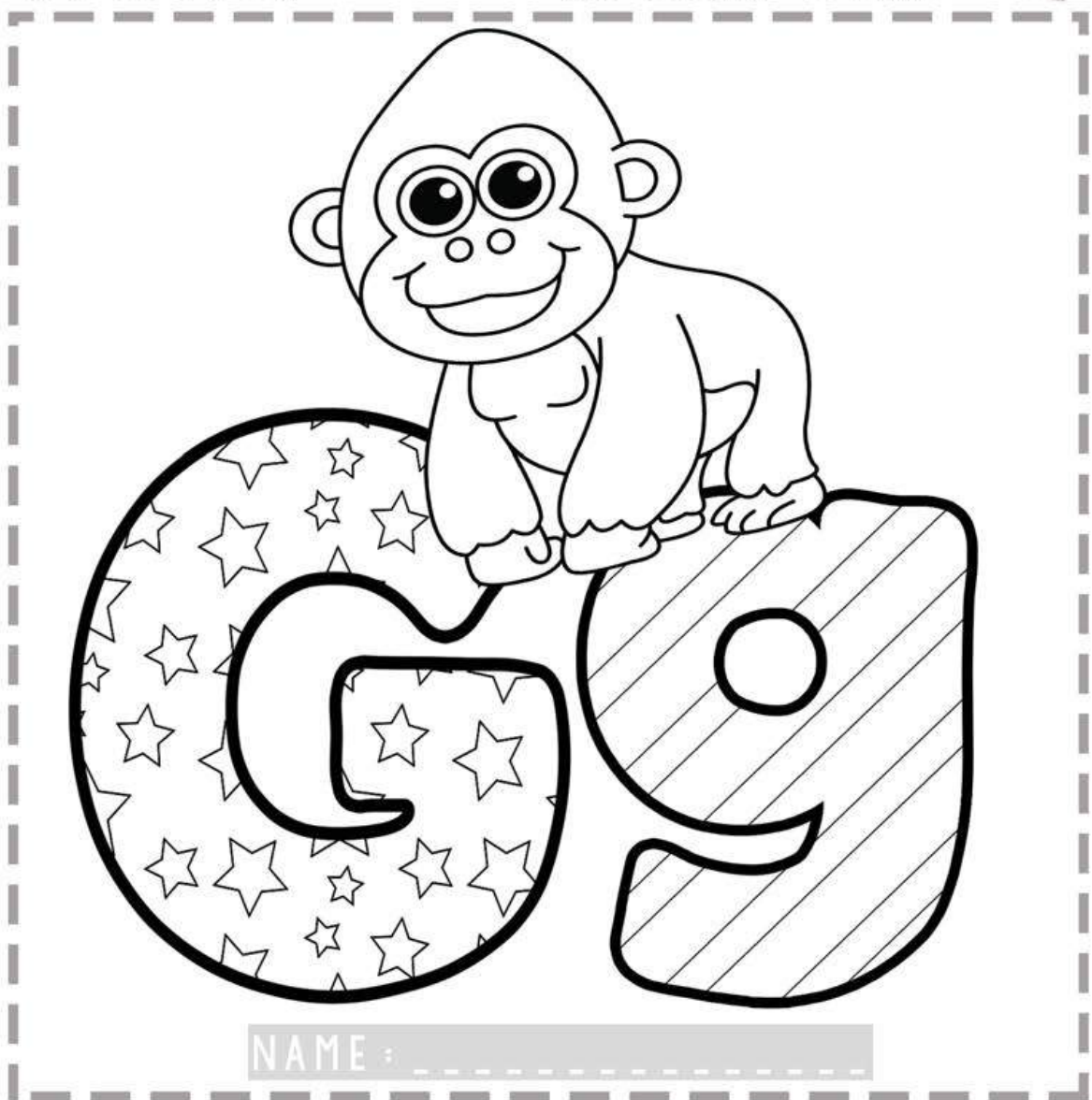

NAME : _____

Gg

Write and read words that begin with letter g.

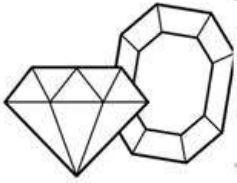

gem gem



gift gift

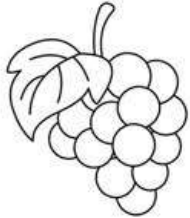

grape grape



glove glove



globe globe



game game

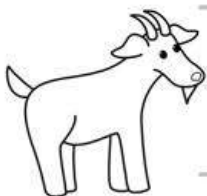

goat goat

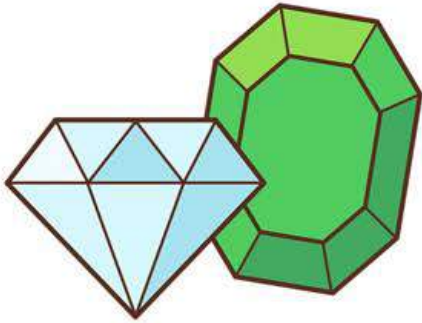

gems



gift



glue



gate

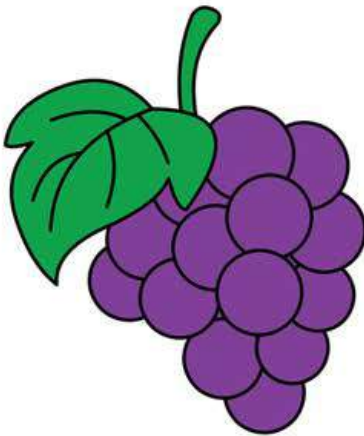

grapes



glasses

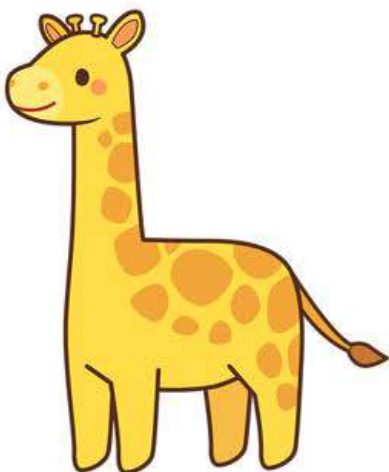

giraffe



glove



globe



LETTER G



4 IN A ROW

LETTER G



4 IN A ROW

LETTER G



4 IN A ROW

LETTER G



4 IN A ROW

I C A N W R I T E

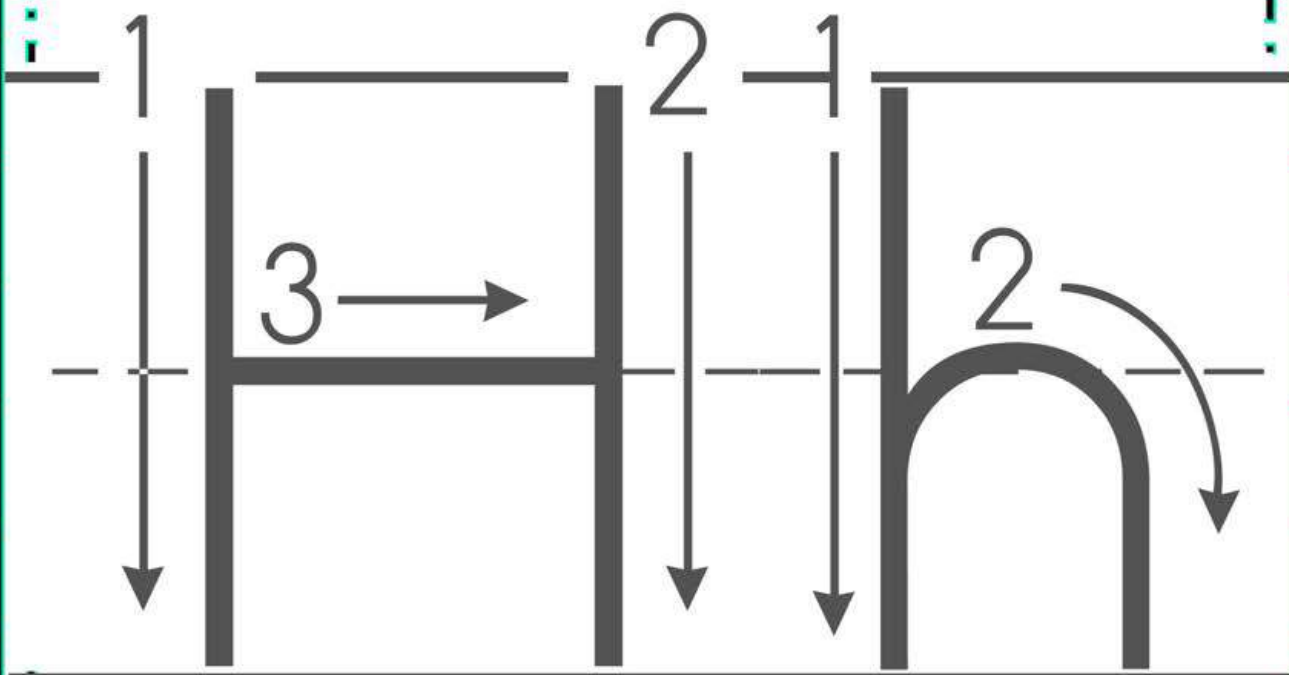

Line Down

Pick up

Line Down

Pick up

Connect

Line Down

Pick up

With a Hump

Helicopter

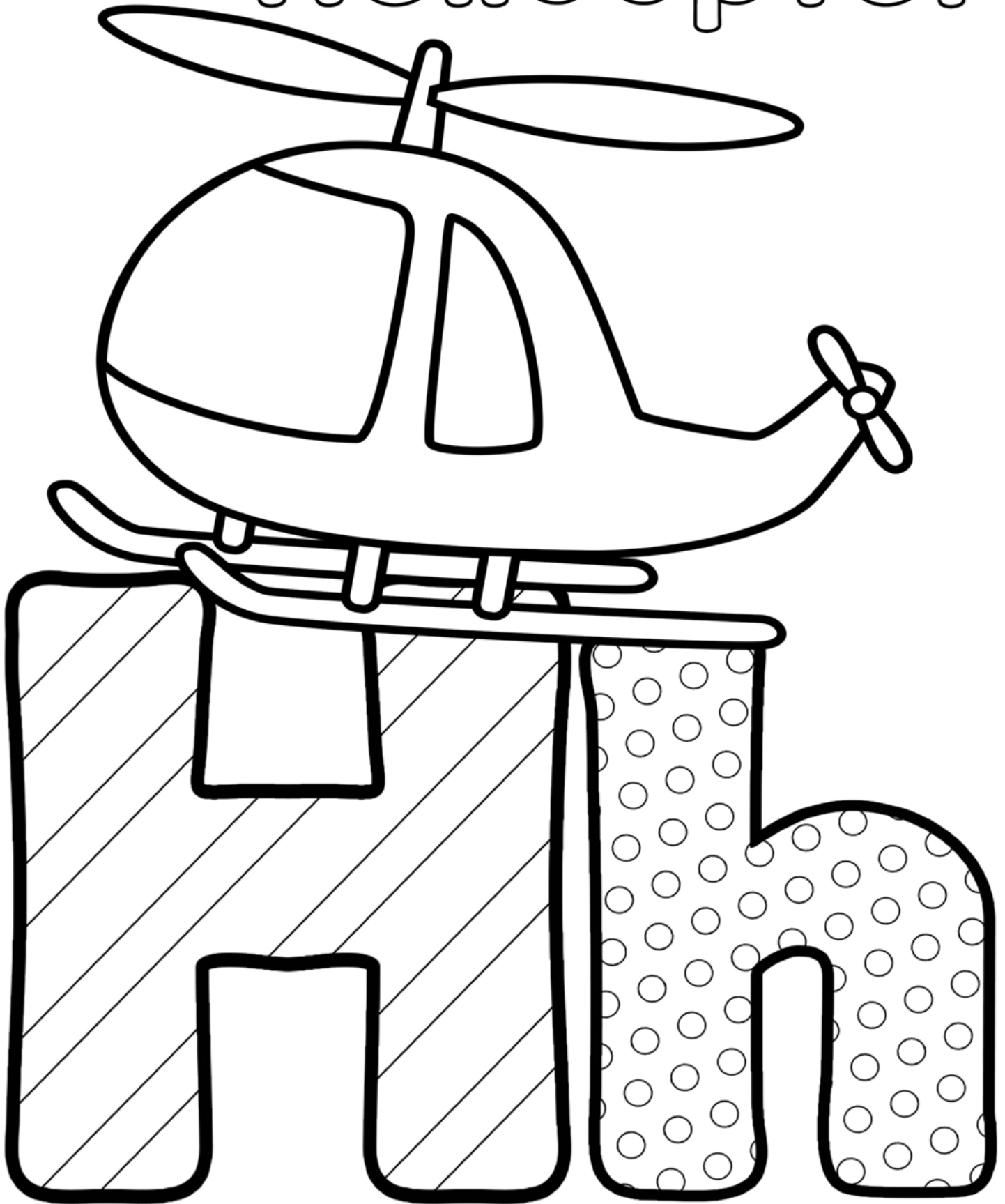

H h

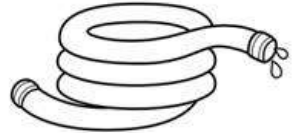
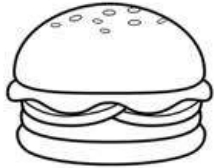
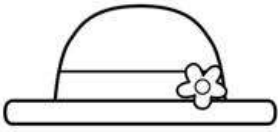
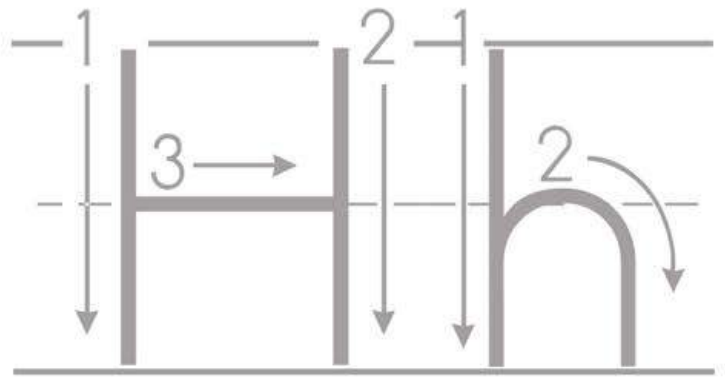

hat

hamburger

horn

helicopter

hose

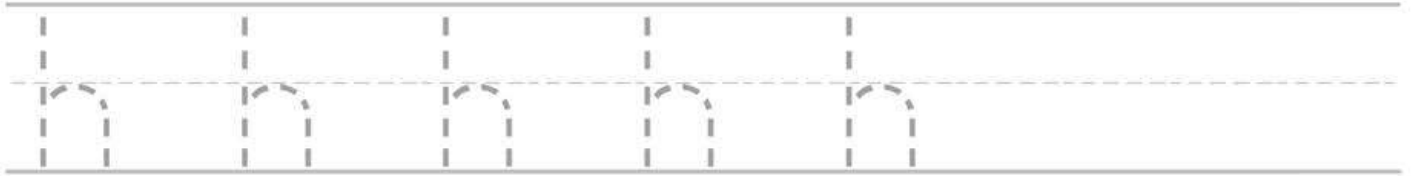
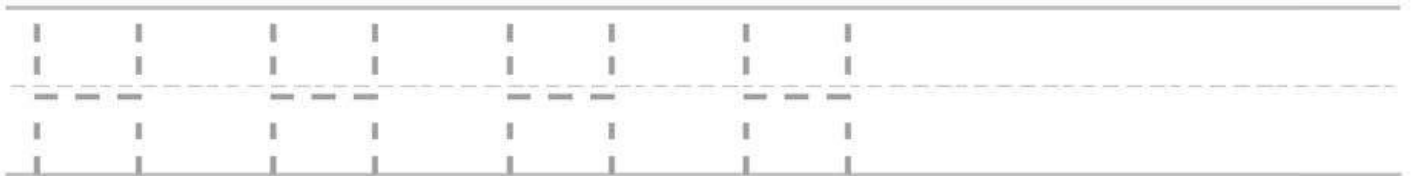
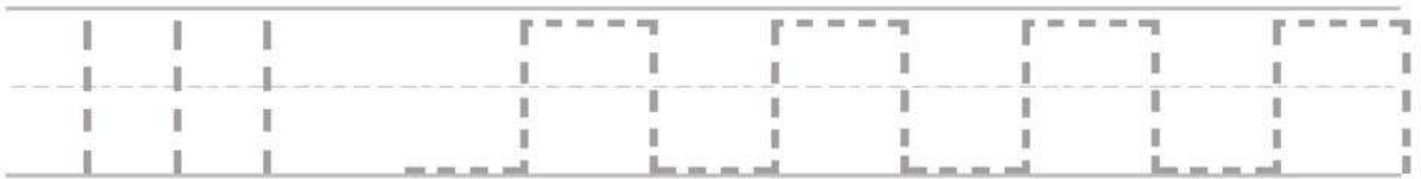

Measure:

Trace the hearts:

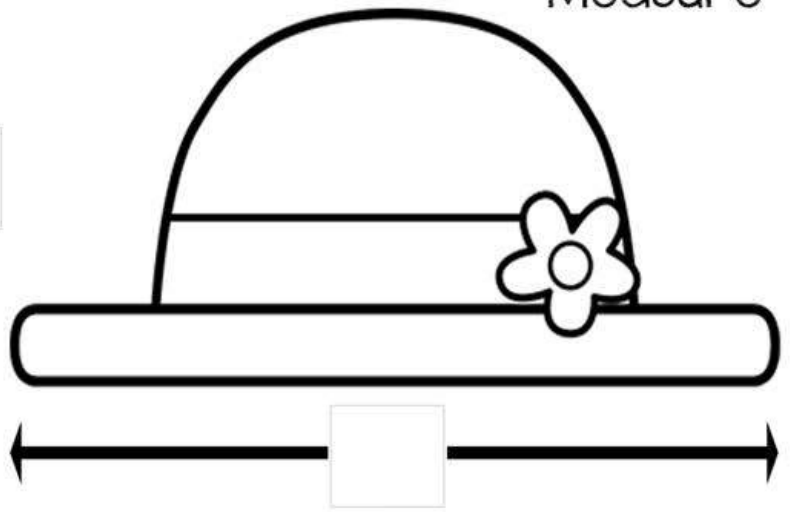

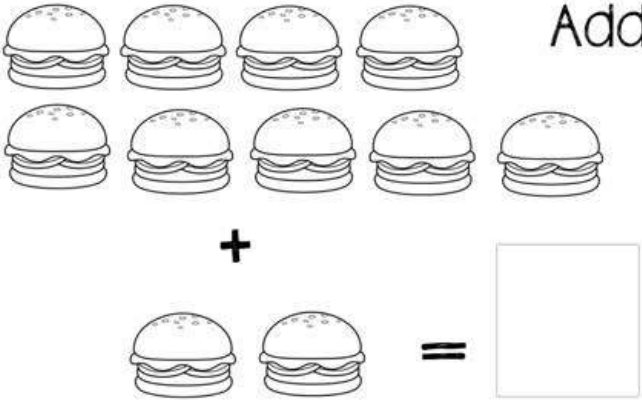

Add

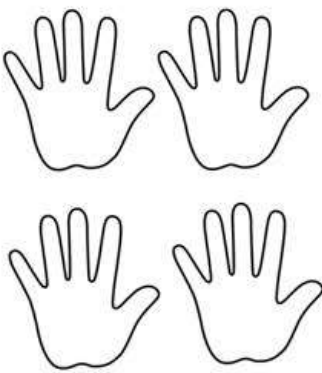

$8 + 2 = \square$

Count & Tally the fingers:



$9 + 1 = \square$
 $9 + 2 = \square$

$$\begin{array}{r} 2 \\ + 9 \\ \hline \square \end{array}$$

$$\begin{array}{r} 9 \\ + 2 \\ \hline \square \end{array}$$

Draw a Tree on the left side of the house:



Cross out the 3rd, 5th, 7th and 9th hammers.

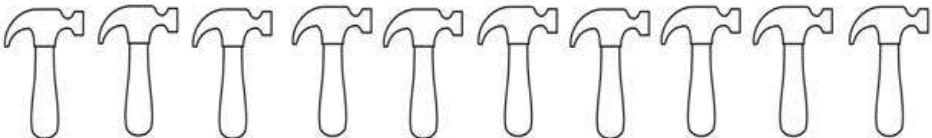

Draw: $9 + 2 = \square$

$+$ $=$

Hh

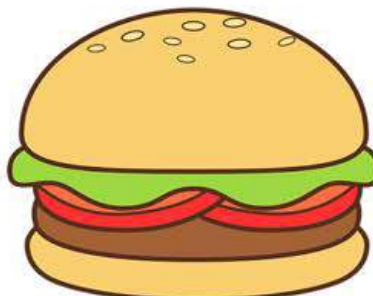
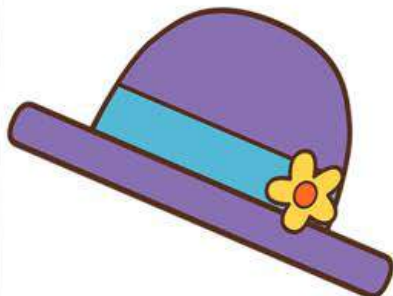
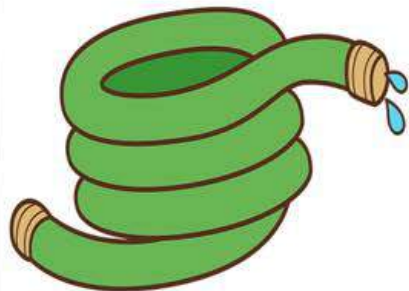
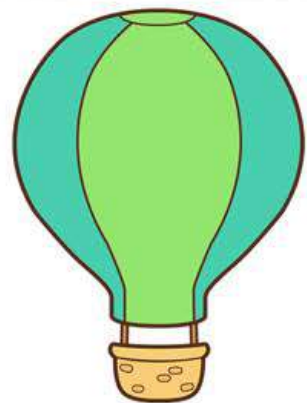

I CAN COLOR

 = hot-air balloon **words with:**

 = hamburger

 = horn

 = hat

 = house

 = helicopter

 = hammer

 = hand

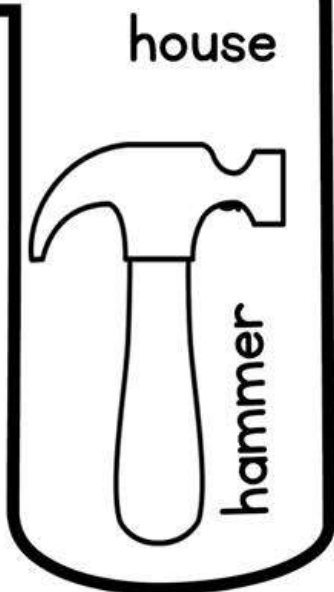
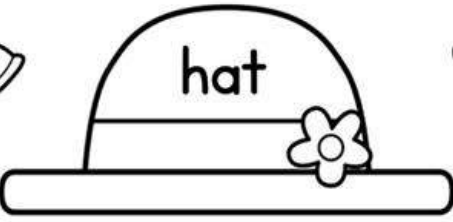
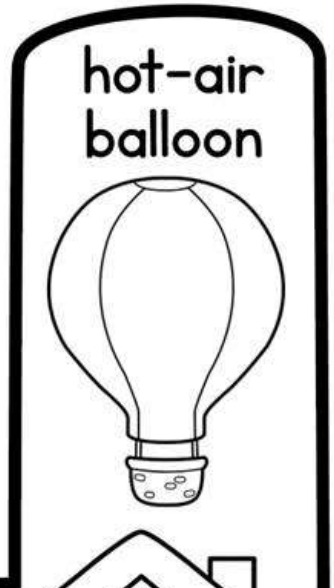
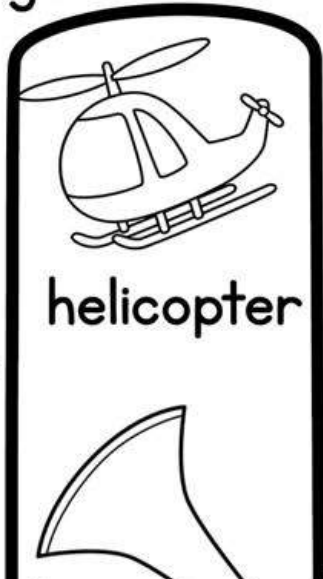

NAME : _____

Hh

Write and read words that begin with letter h.

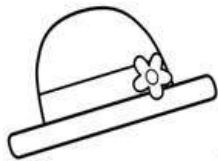

hat hat hat



hand hand

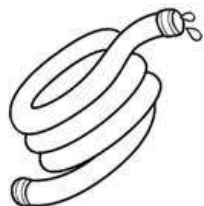

hose hose



horn horn



house house



heart heart

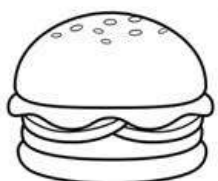

hamburger

NAME : _____

Hh

Write and read words that begin with letter h.

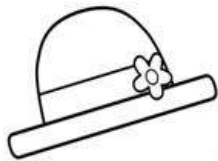

hat hat hat



hand hand

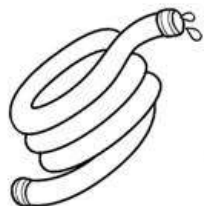

hose hose



horn horn



house house



heart heart

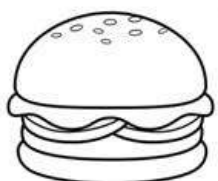

hamburger

NAME : _____

RACE TO THE TOP

Use a paperclip and a pencil to complete the spinner.

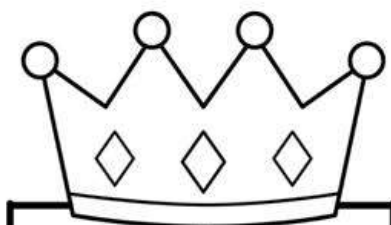

H	h
H	h
H	h
H	h
H	h
H	h
H	h
H	h
H	h
H	h
H	h

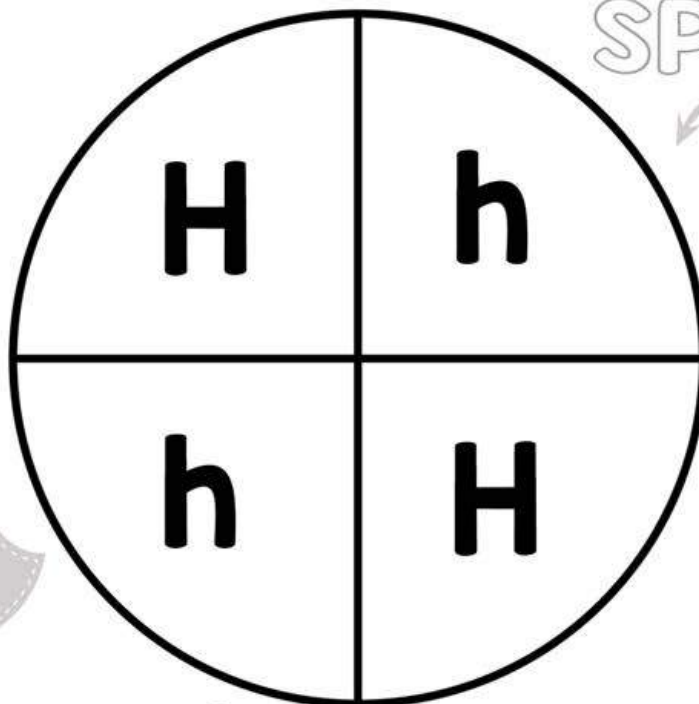

SPIN



Record

Report:

How many spins landed on H?

How many spins landed on h?

Which had more?

Write an inequality: >

How many spins total?

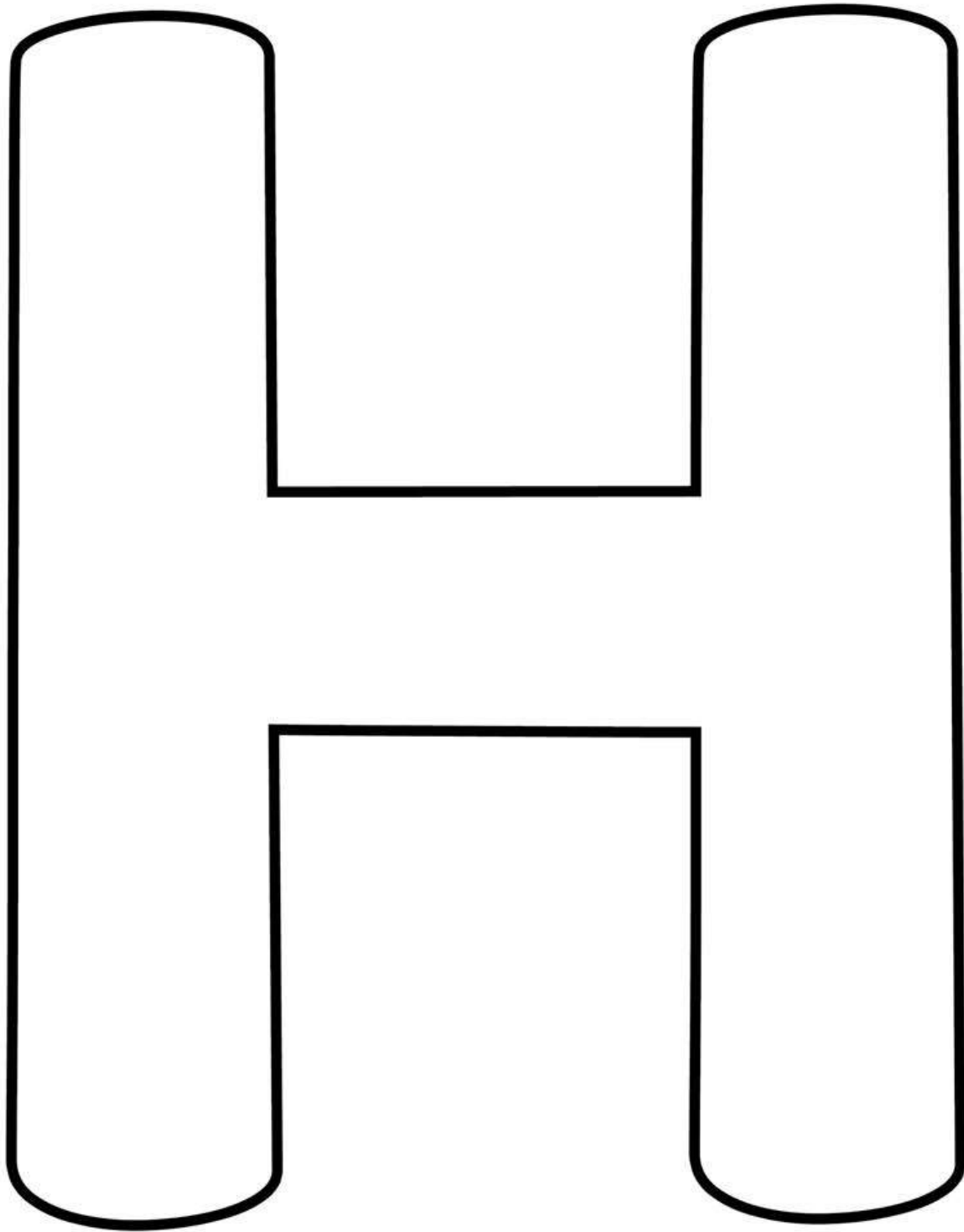

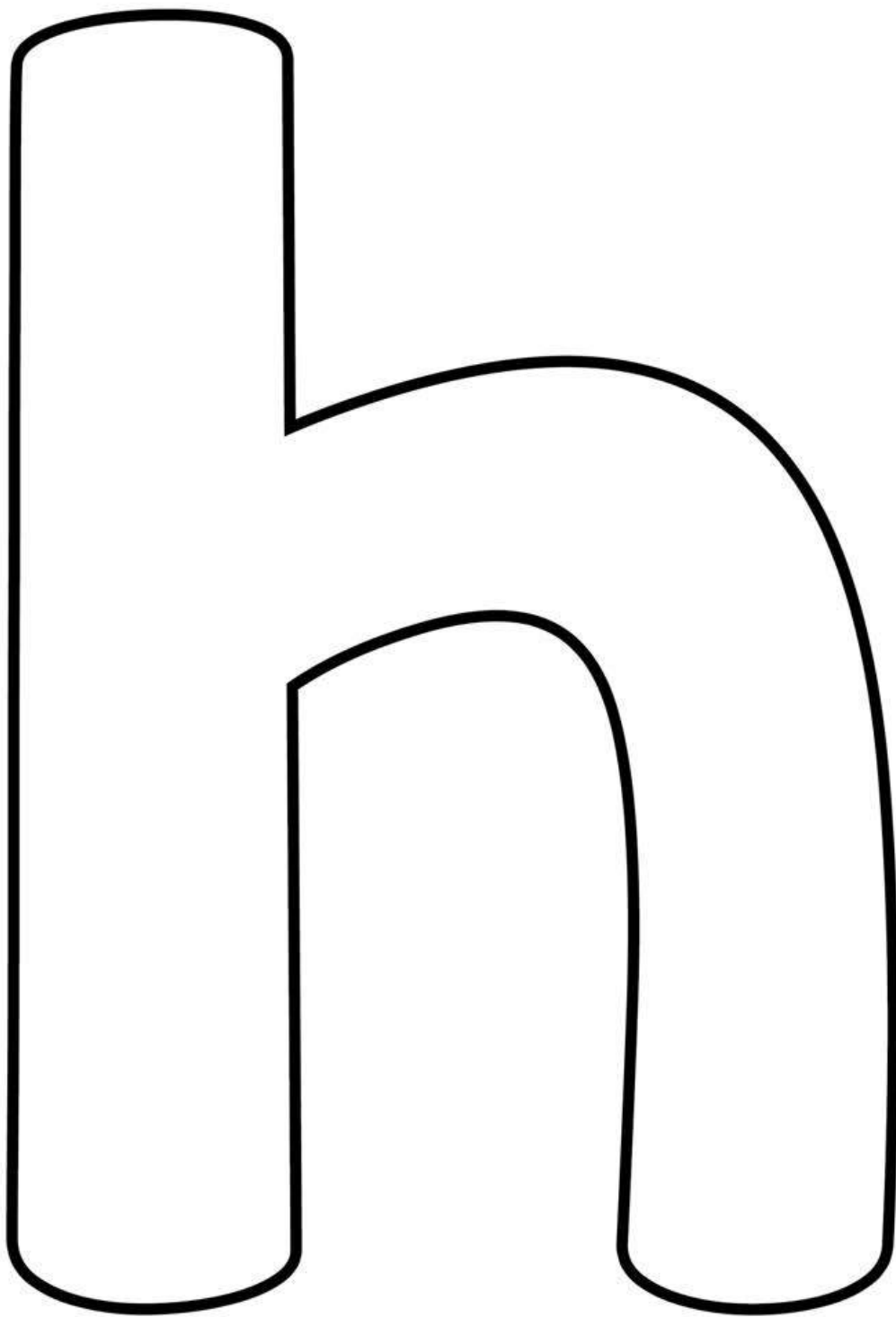

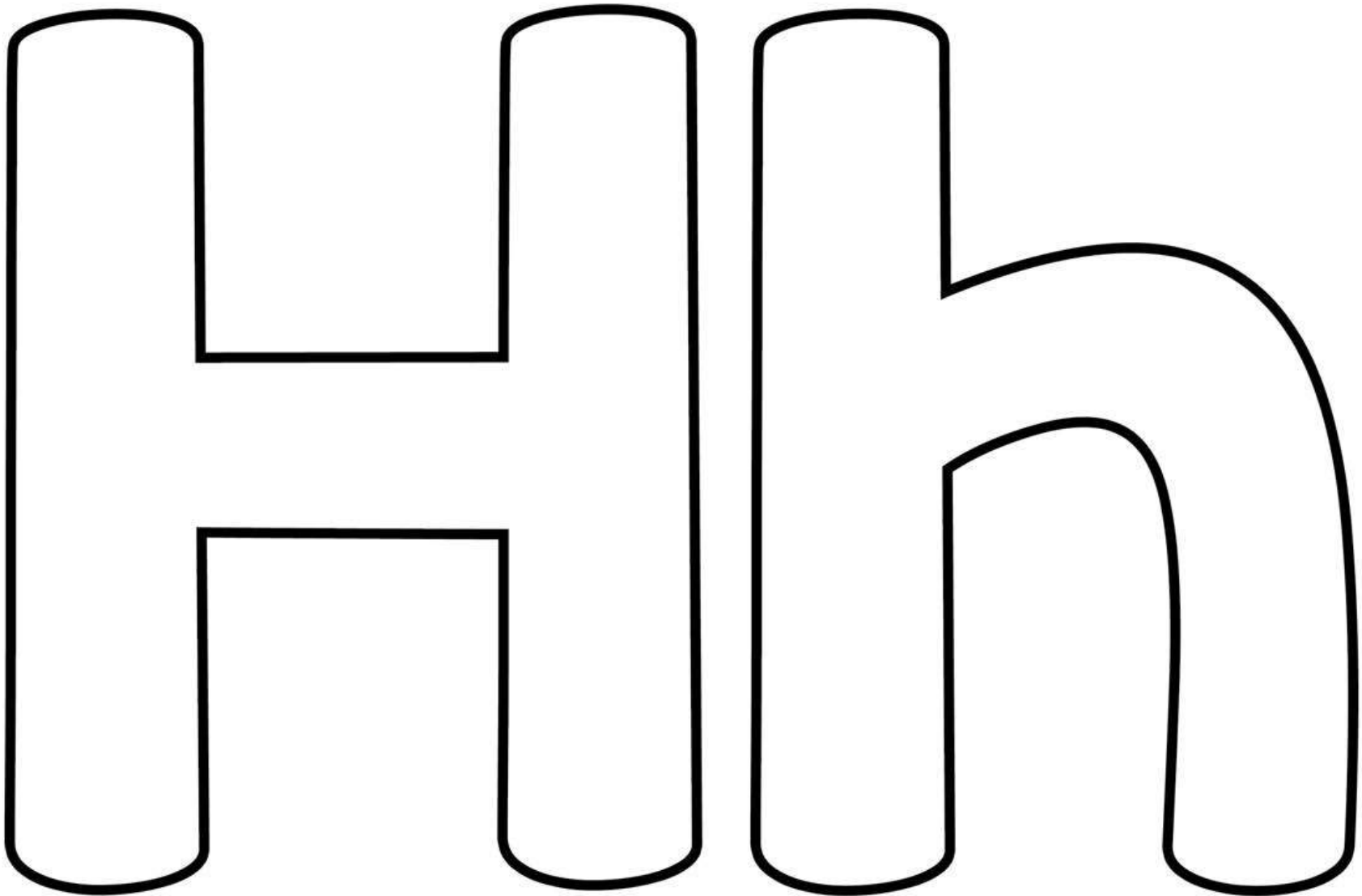

I C A N F I N D

the letter:

A B
F G
J H
F G
H G H
A Q
F K
H B F
G H
H M

E V
H G
L F H
E G
P T
Y G U
G K
L M
Y H
H R E

g n
h b h
l f x
r h r
h a n
w h
g h g
c h g
h f e
w h
h g n

e f l h g c
o h b f n g
a h q
n g r
a p n
h a o
w t

How Many?

How Many?

TRACE

NAME : _____

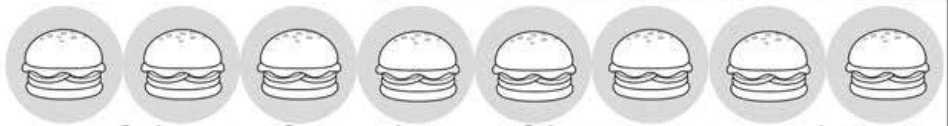

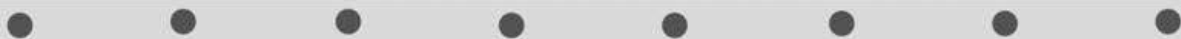
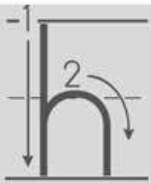
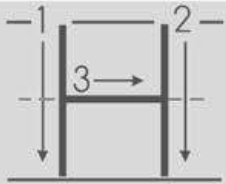

Color one for each row of letters you complete

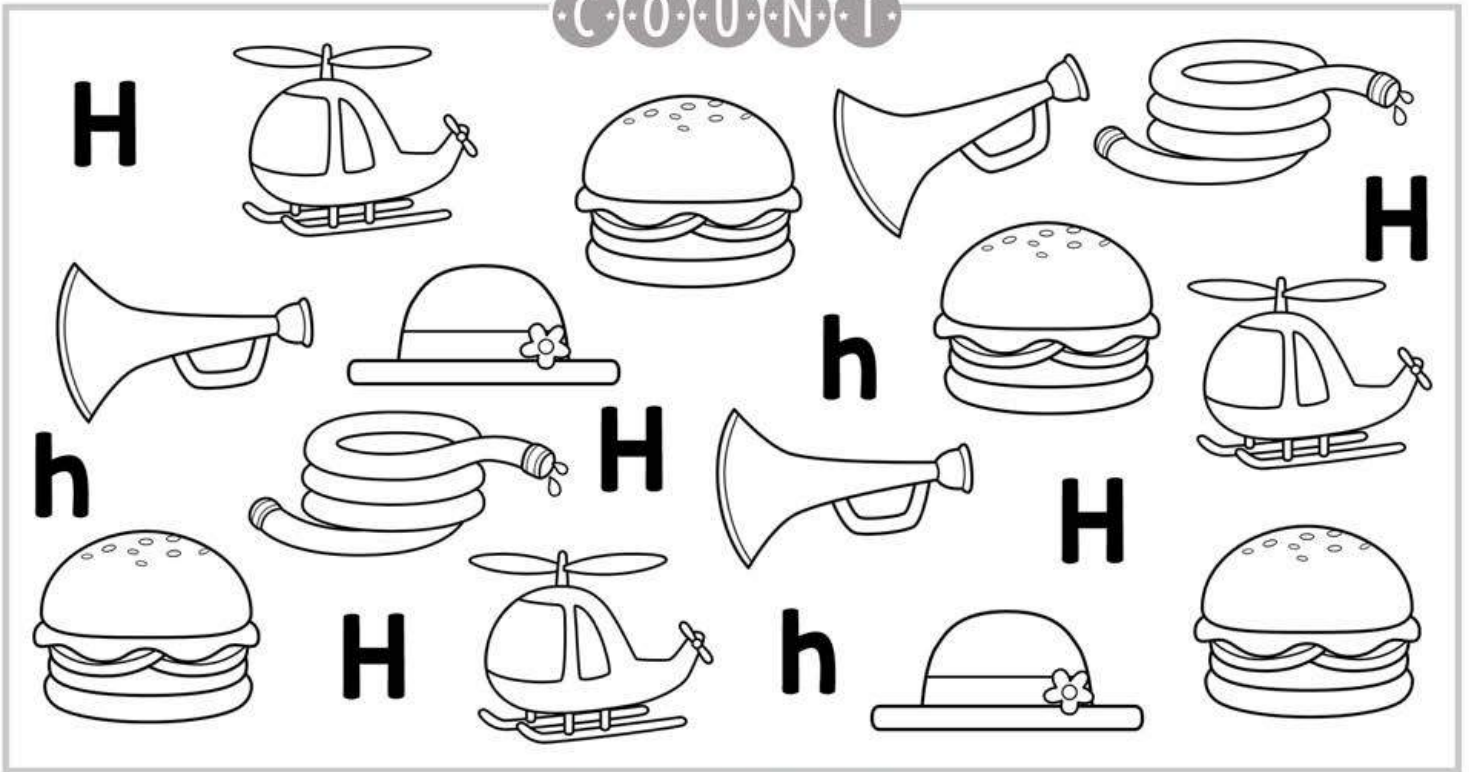

C · O · U · N · T

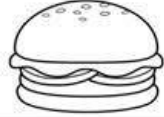
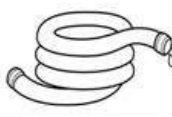
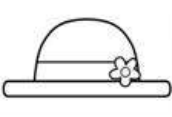

G · R · A · P · H

H	h					

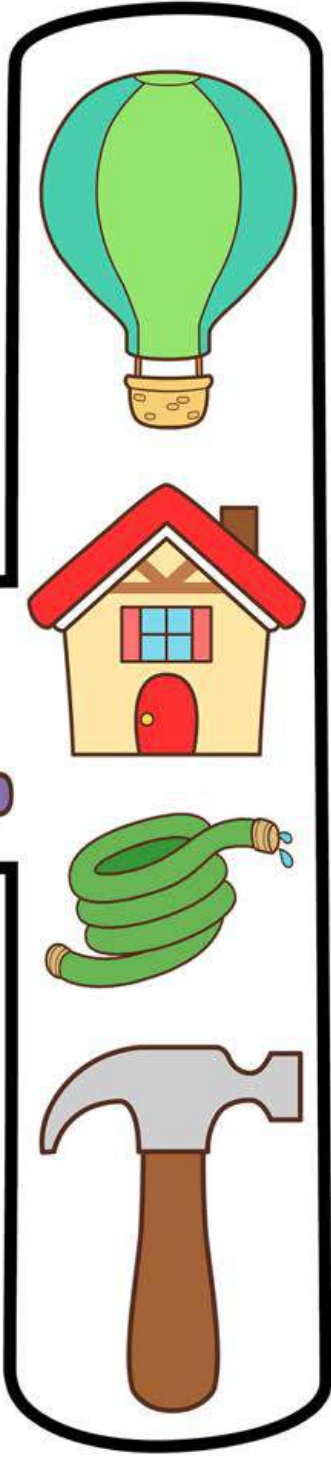
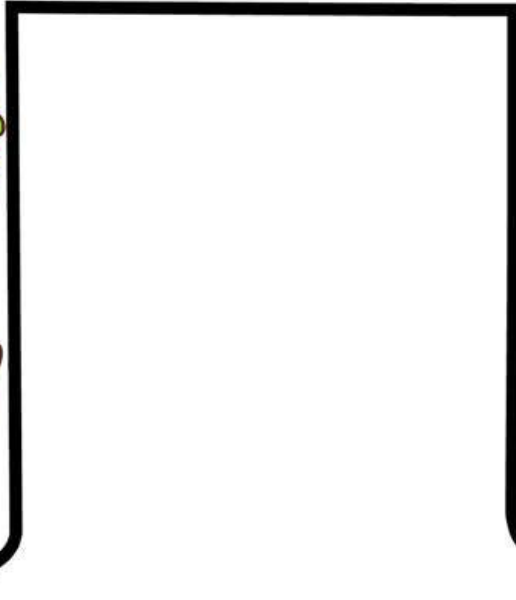
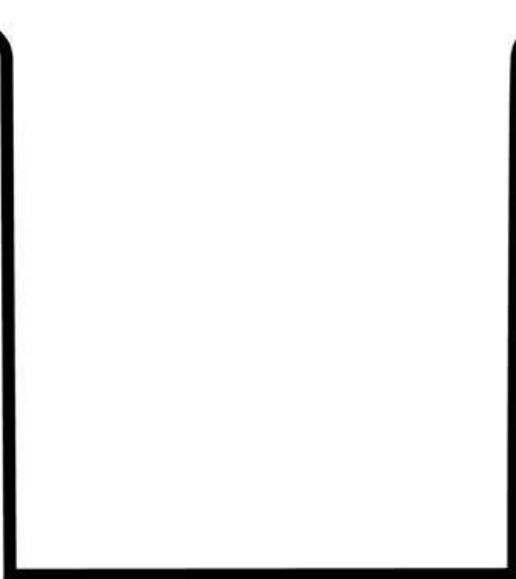

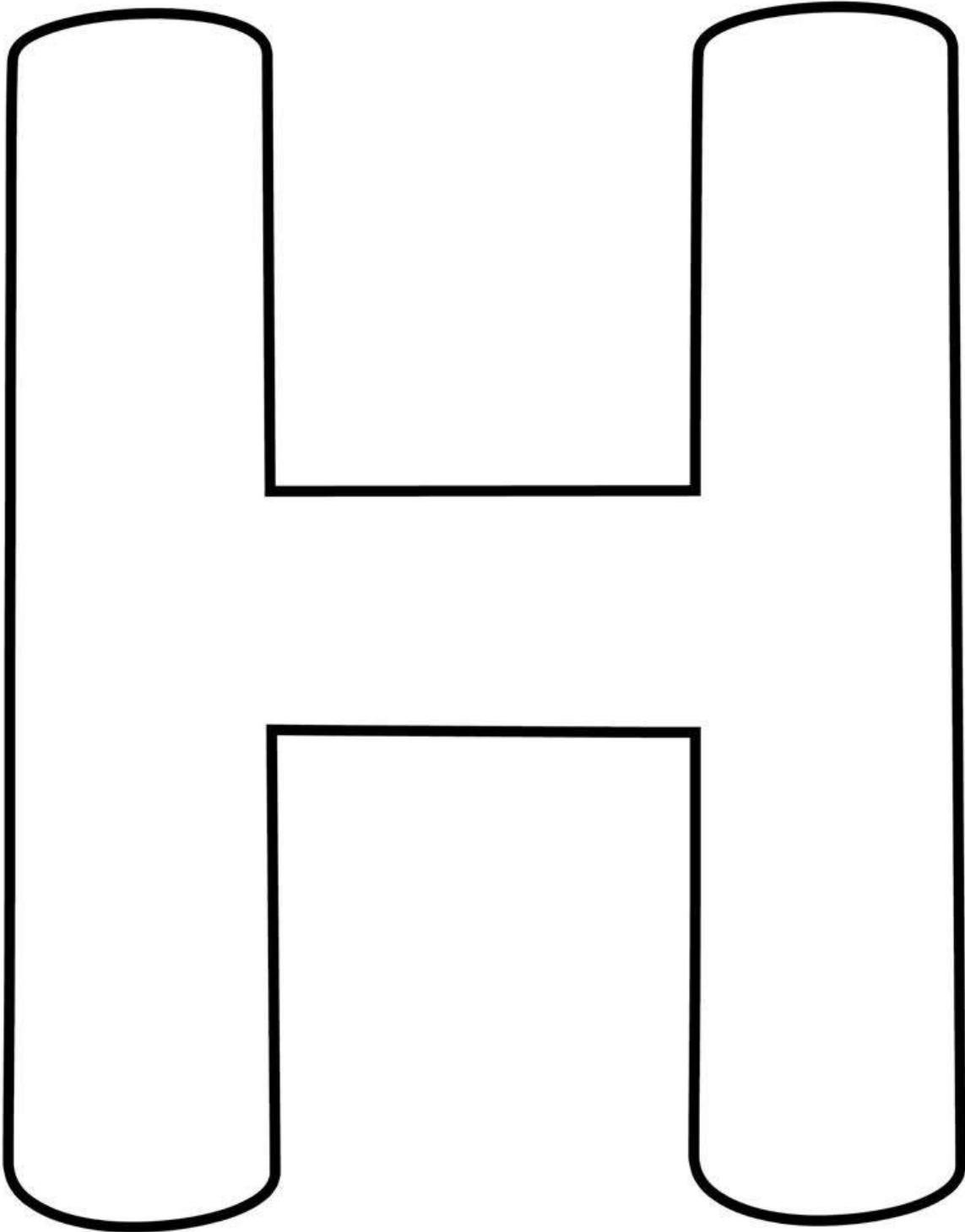

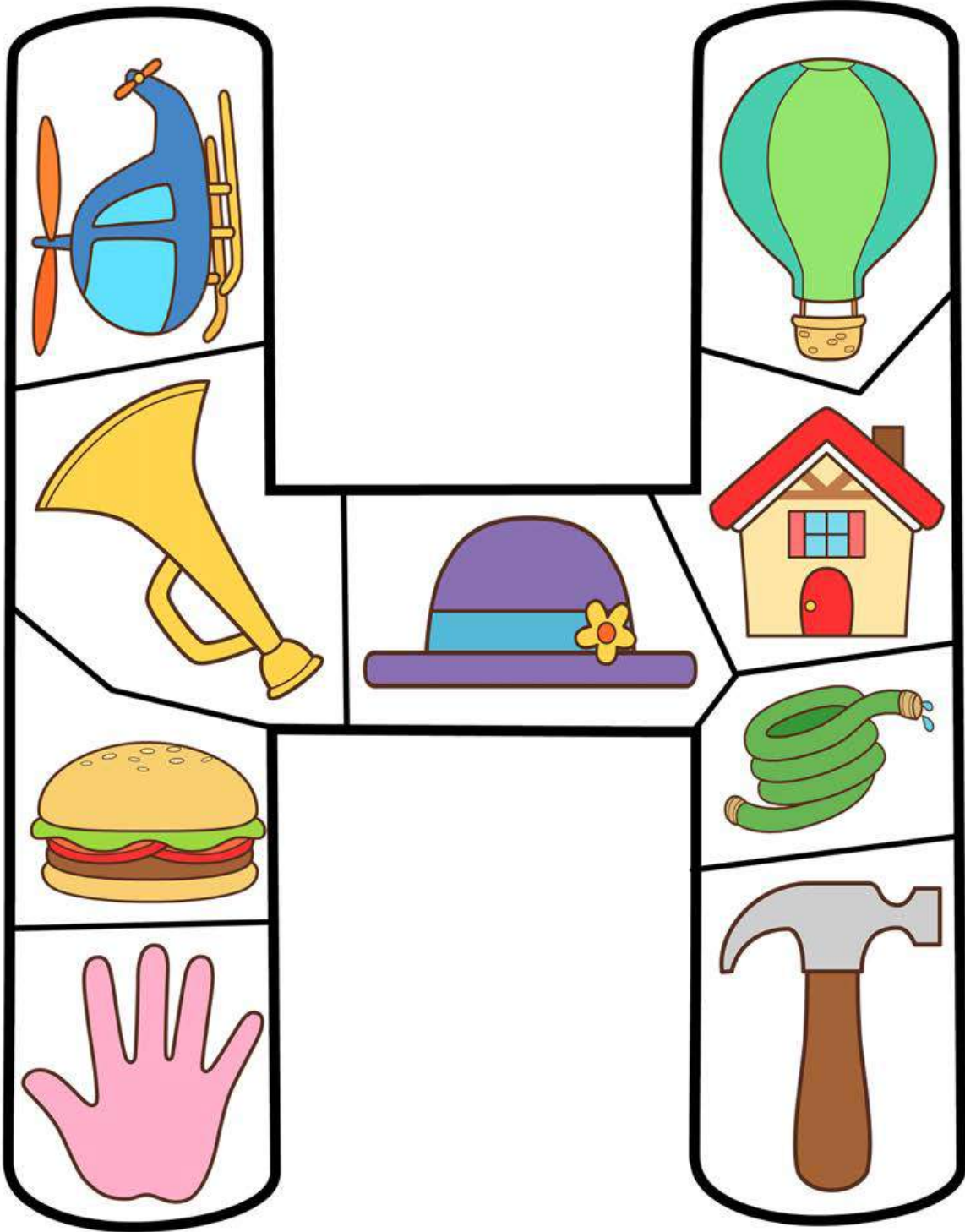

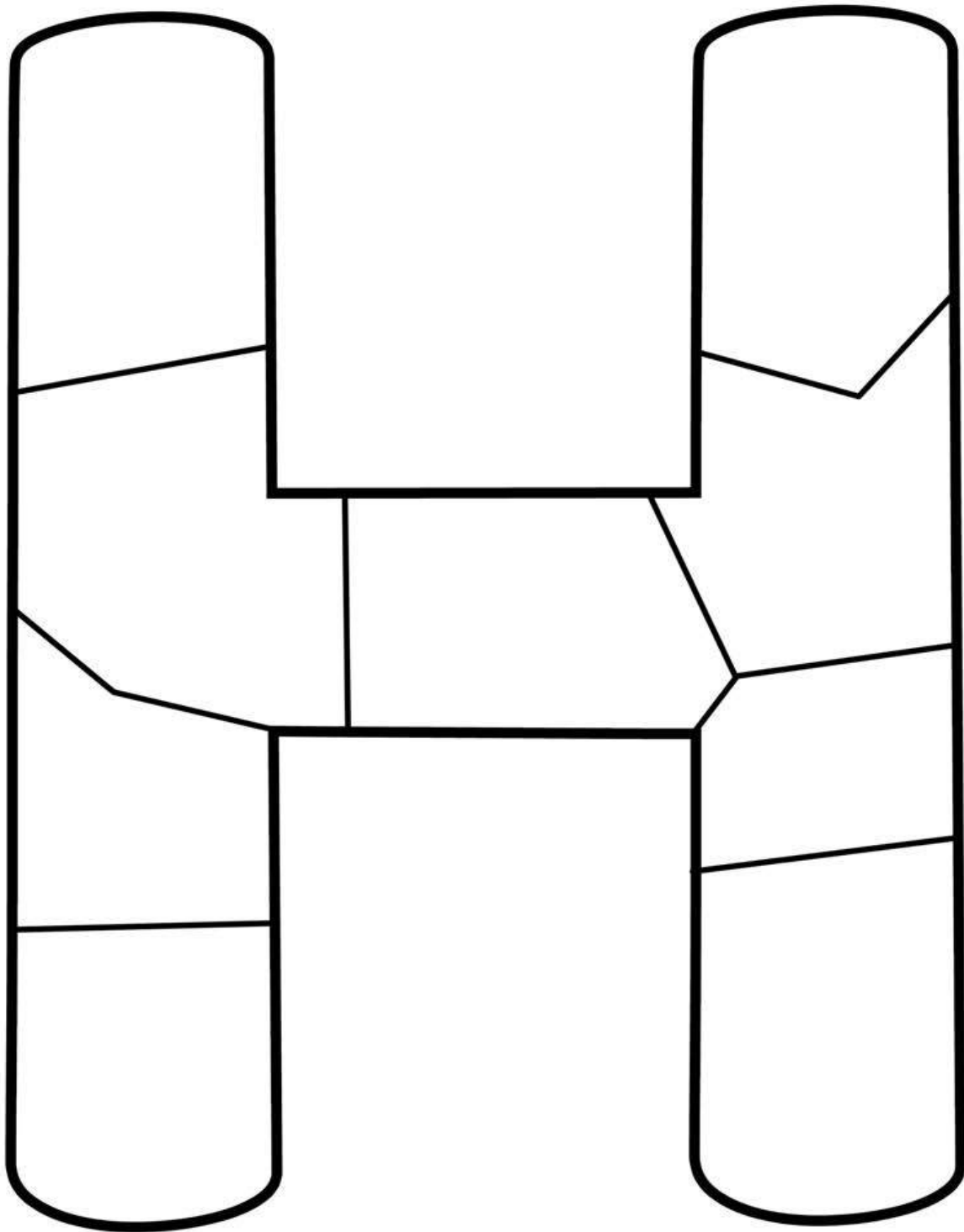

1. Write

2. Cut Out 

A B C Q U I L T

3. Color

4. Cut out 

NAME : _____

Q	U	I	L	T
Q	U	I	L	T
Q	U	I	L	T
Q	U	I	L	T

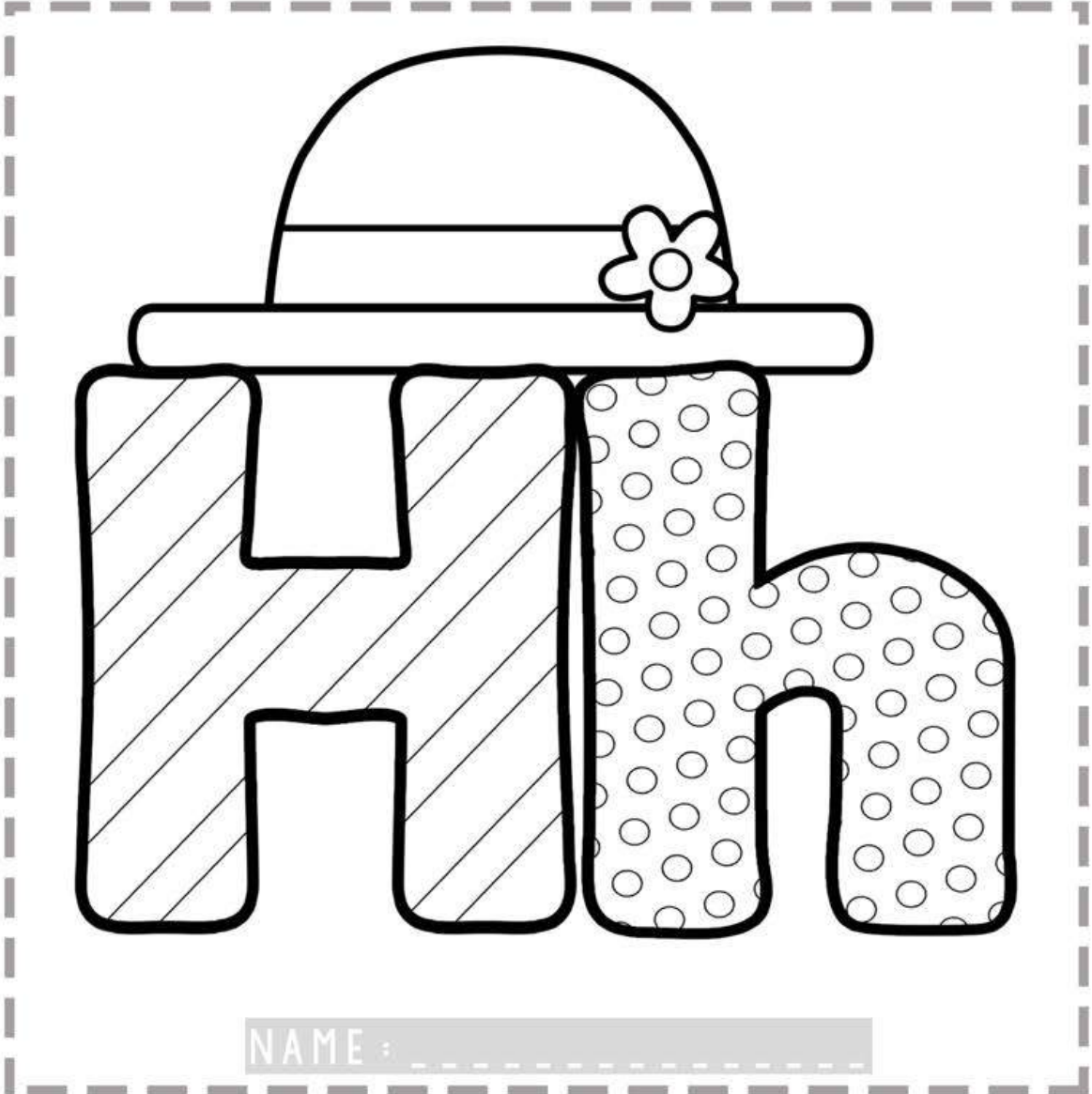

NAME : _____

Hh

Write and read words that begin with letter h.

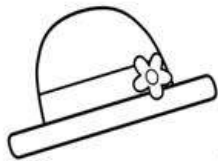

at at at



and and

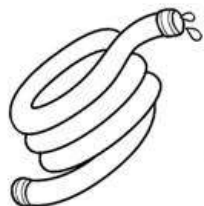

ose ose



orn orn



ouse ouse



heart heart

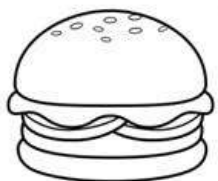

hamburger



house

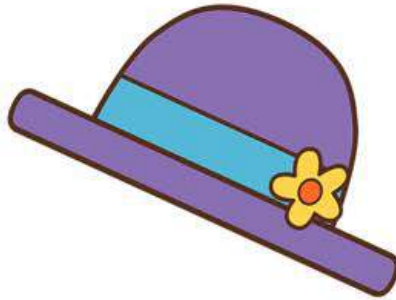

hat

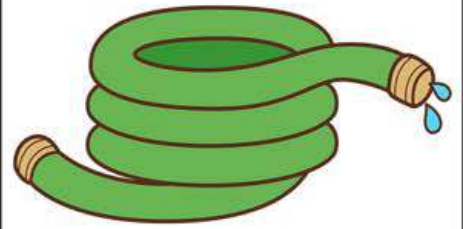

hose



helicopter



hammer

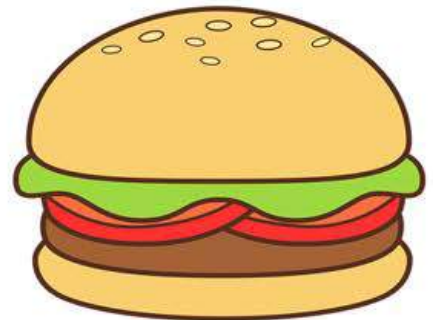

hamburger



horn



hand

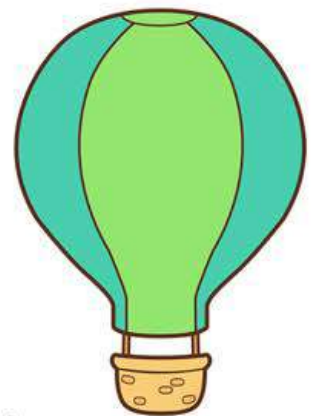



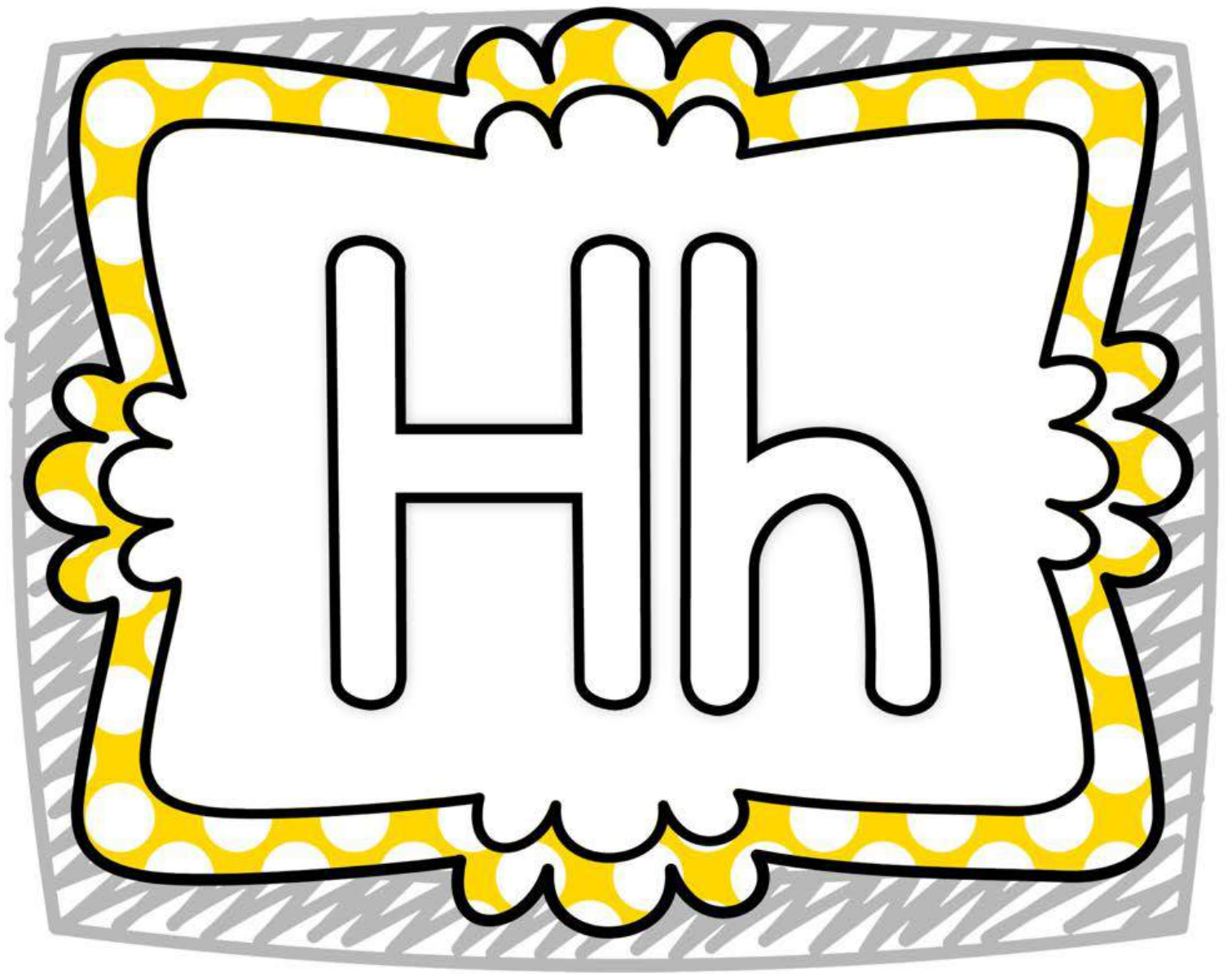











hot air
balloon

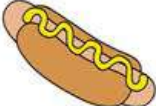

LETTER H















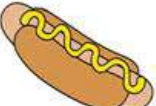

4 IN A ROW

LETTER H







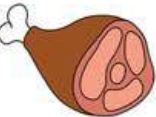









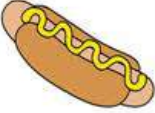

4 IN A ROW

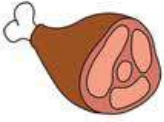
LETTER H





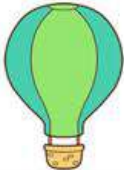











4 IN A ROW

LETTER H

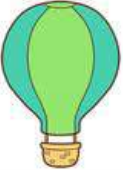

4 IN A ROW

I C A N W R I T E

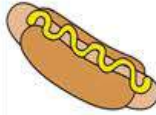
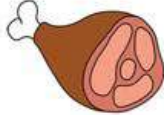

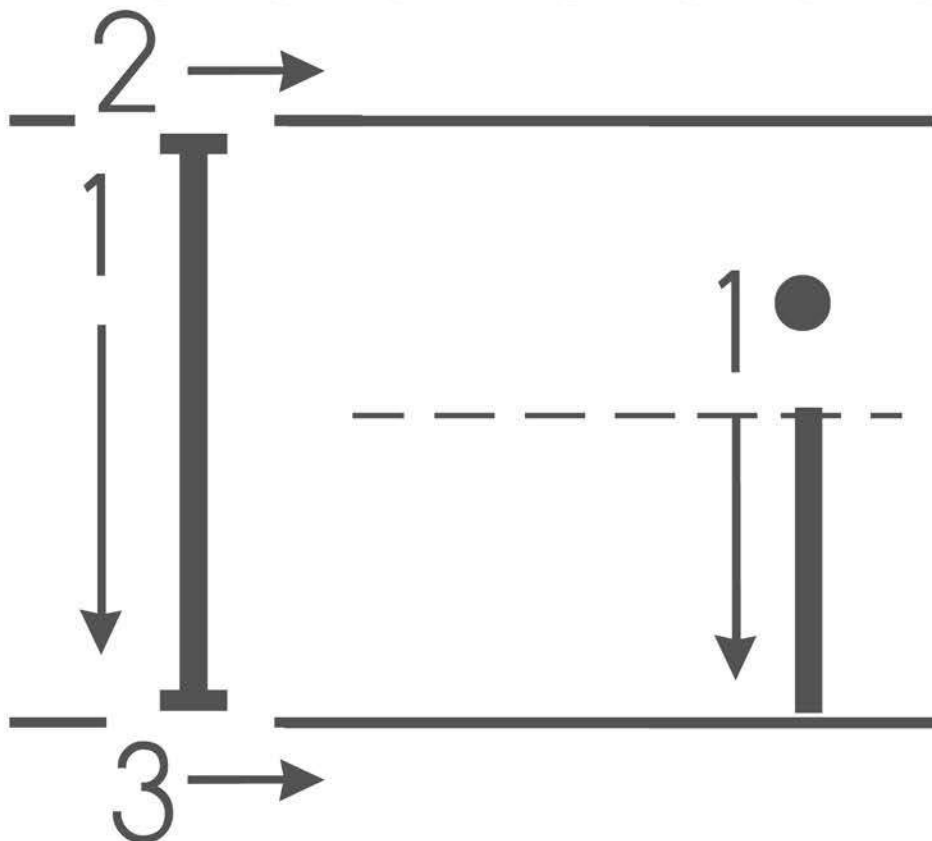
Line Down

Pick up

Dash

Dash

Line Down

Pick up

Dot on Top

Ice Cream

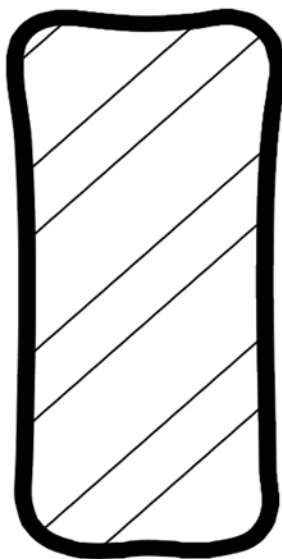
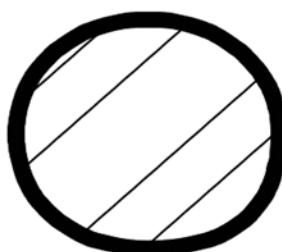
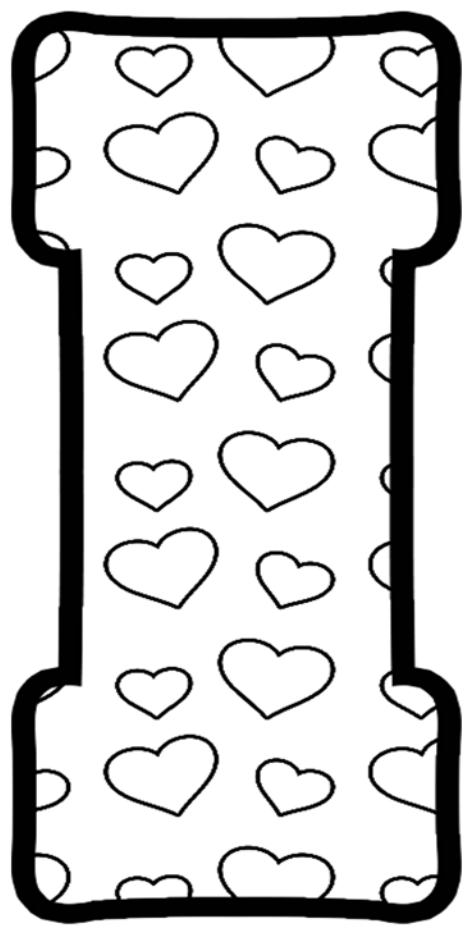
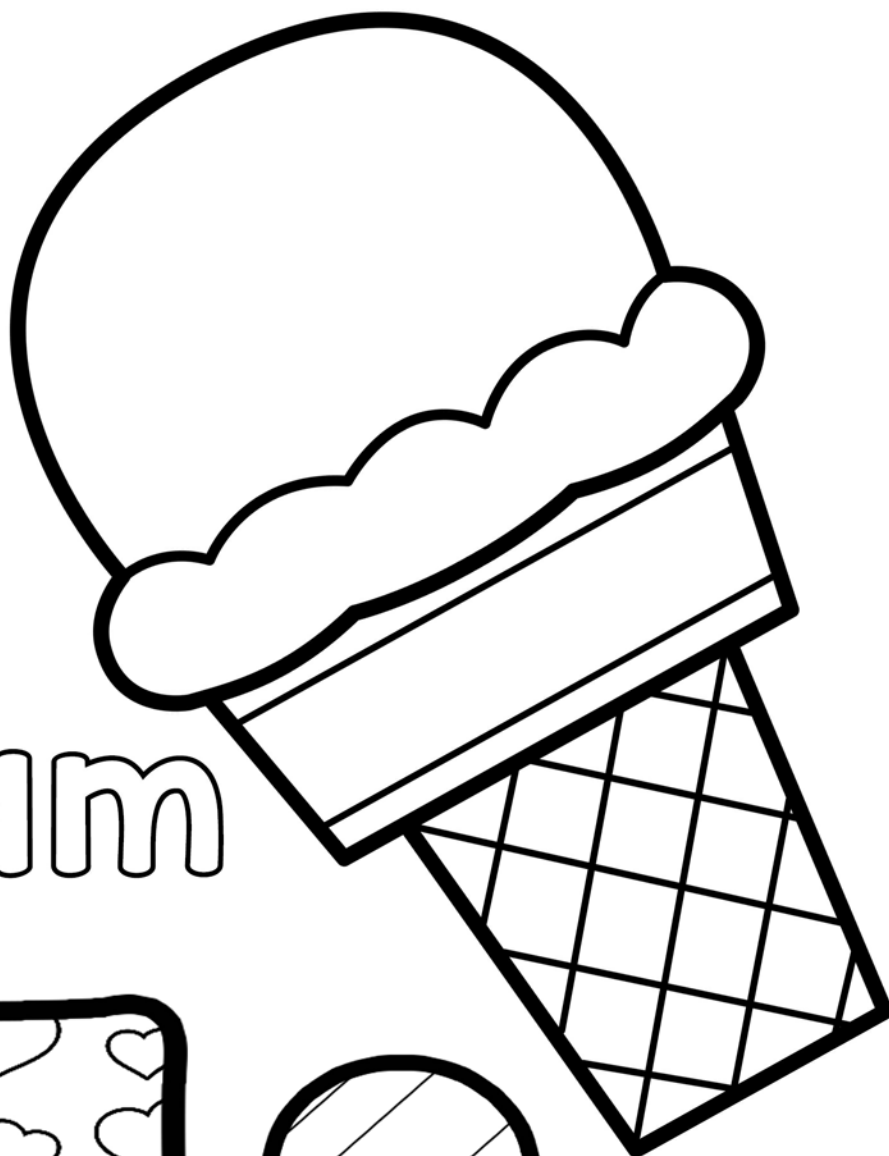

I i

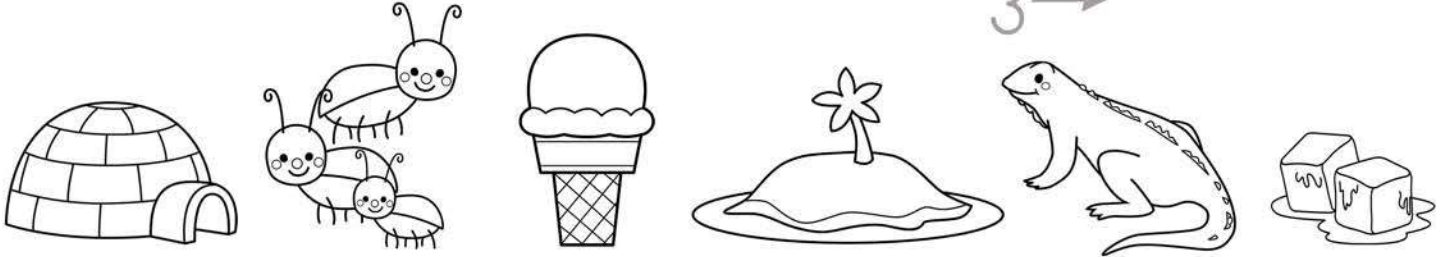
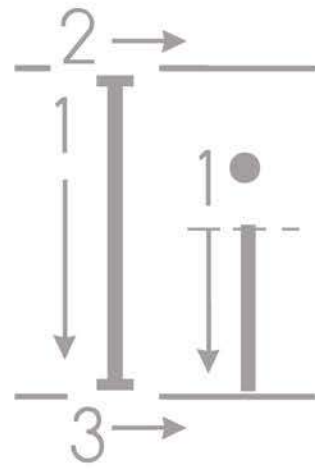

igloo insects ice cream island iguana ice

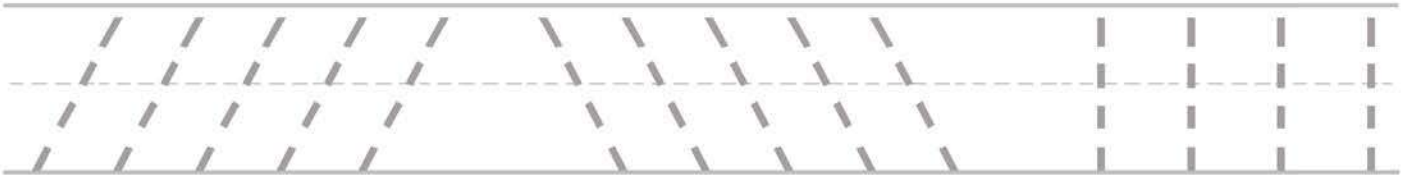

Give each cone 3 more scoops



Measure:

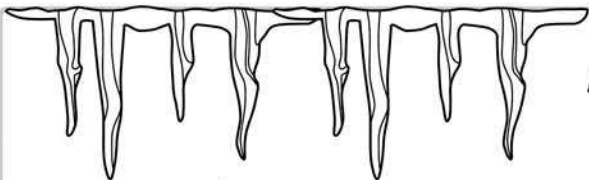
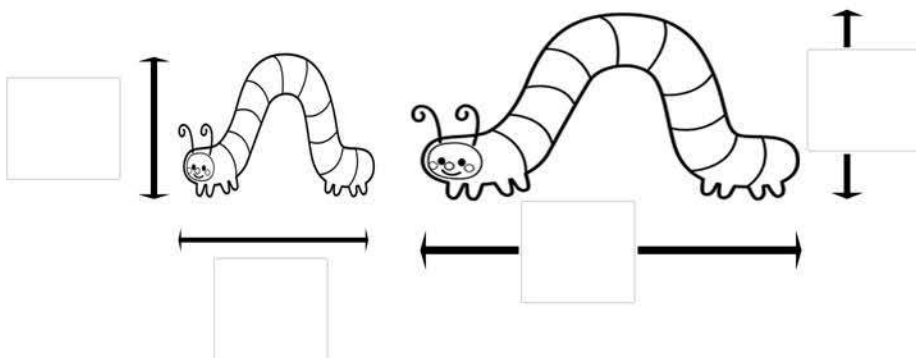

Add

+

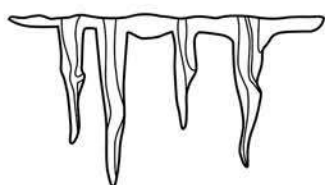

=



Count & Tally the leaves

$$10 + 1 = \square$$

$$10 + 2 = \square$$

$$\begin{array}{r} 2 \\ + 10 \\ \hline \square \end{array}$$

$$\begin{array}{r} 10 \\ + 2 \\ \hline \square \end{array}$$

Draw three worms in front of the iguana.

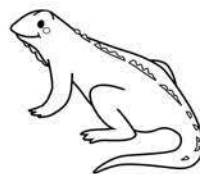

Color the 2nd, 4th, 6th, 8th, and 10th ice cubes:

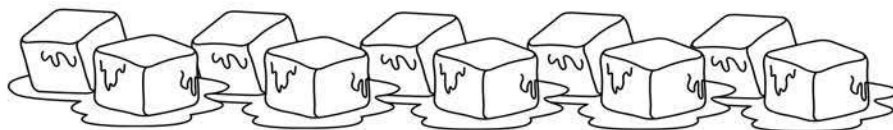

Draw: $10 + 1 = 11$
 $\quad \quad \quad + \quad \quad =$

Ii

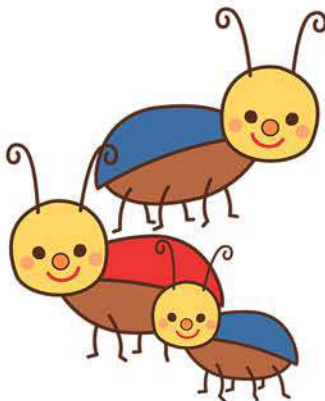
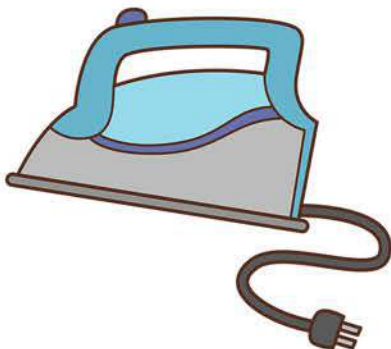
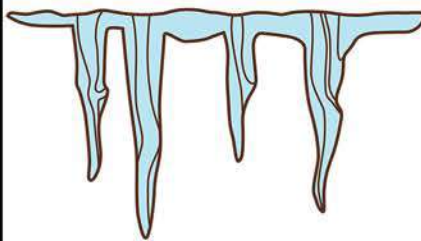
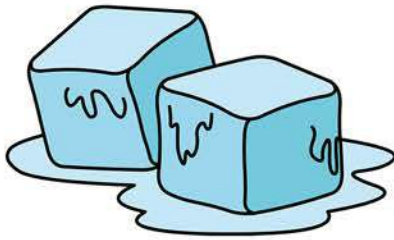
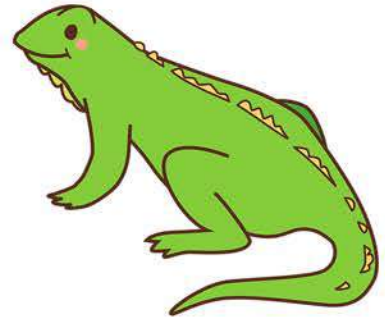
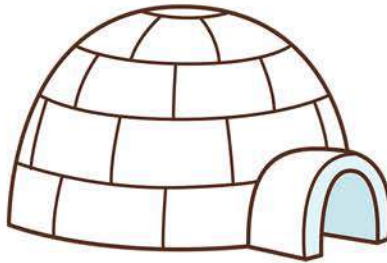
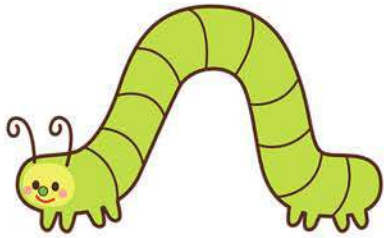

I CAN COLOR

words with:

 = insects

 = ivy

 = iguana

 = ice

 = igloo

 = icecream

 = icicles

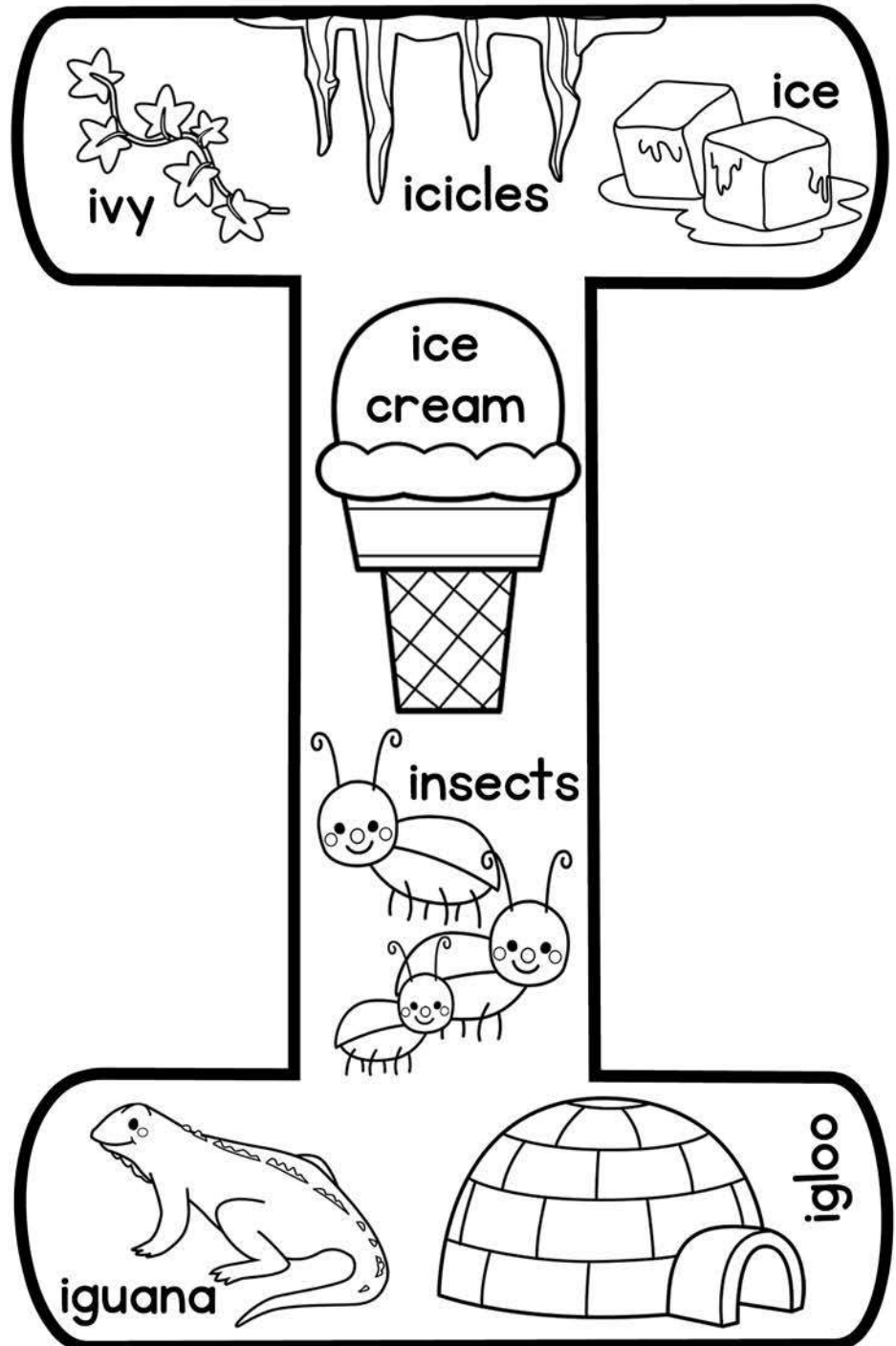

NAME : _____

Ii

Write and read words that begin with letter i.

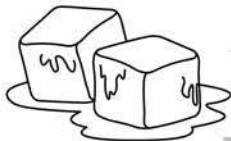

ice ice ice



ivy ivy ivy

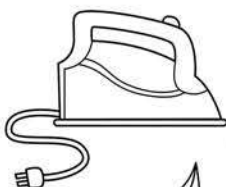

iron iron iron



ink ink ink

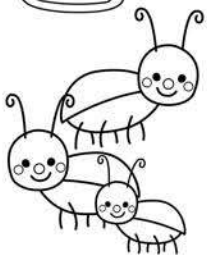

insect insect

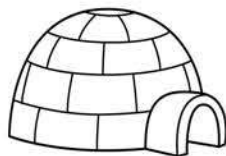

igloo igloo

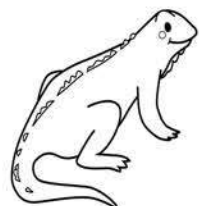

iguana iguana

NAME : _____

Ii

Write and read words that begin with letter i.

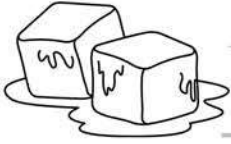

ice ice ice



ivy ivy ivy

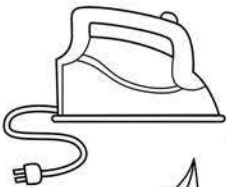

iron iron



ink ink ink

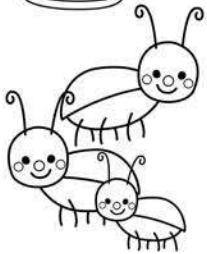

insect insect

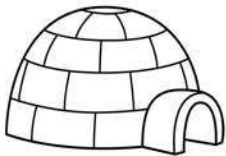

igloo igloo

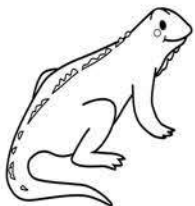

iguana iguana

NAME : _____

RACE TO THE TOP

Use a paperclip and a pencil to complete the spinner.

— — — — —	· · · · ·
— — — — —	· · · · ·
— — — — —	· · · · ·
— — — — —	· · · · ·
— — — — —	· · · · ·
— — — — —	· · · · ·
— — — — —	· · · · ·
— — — — —	· · · · ·
— — — — —	· · · · ·
I	i

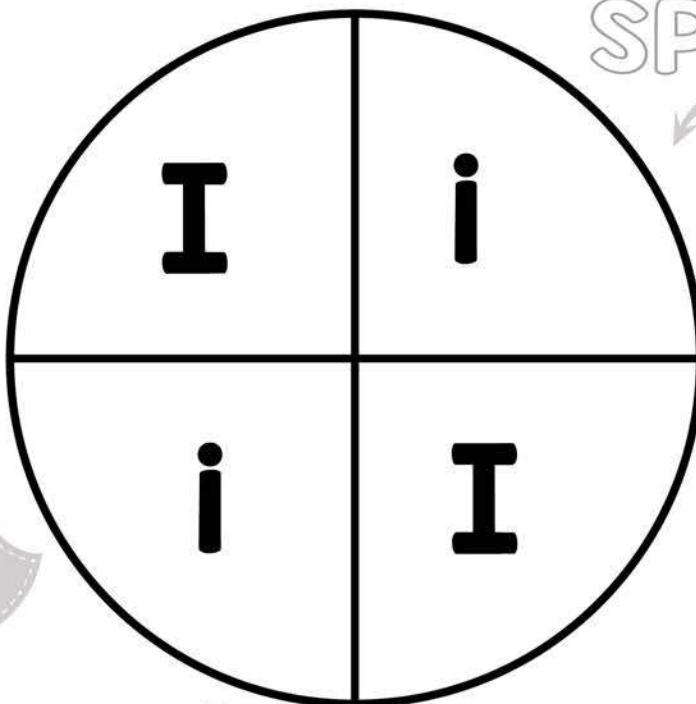

SPIN



Record

Report:

How many spins landed on I?

How many spins landed on i?

Which had more?

Write an inequality: >

How many spins total?

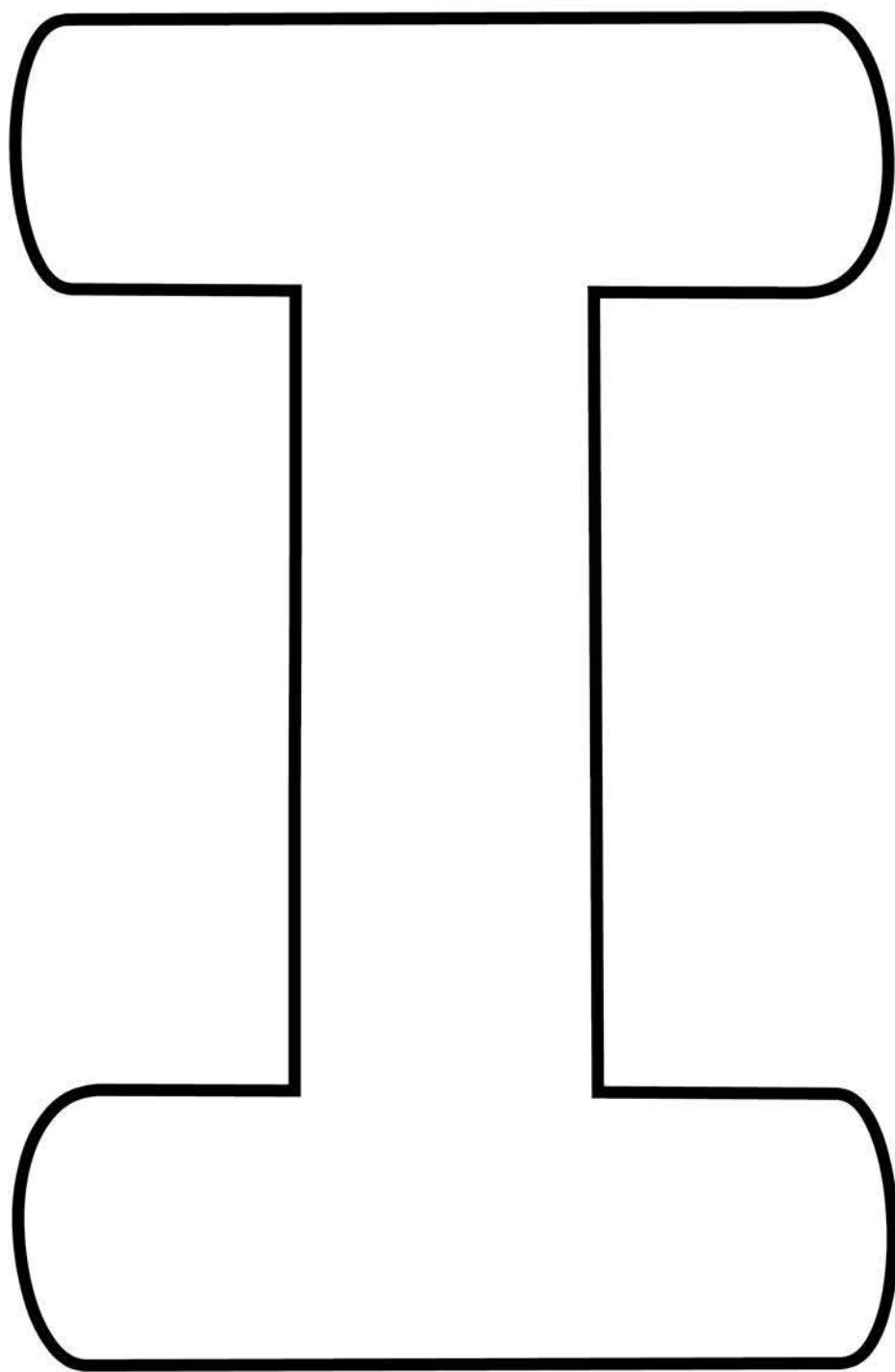

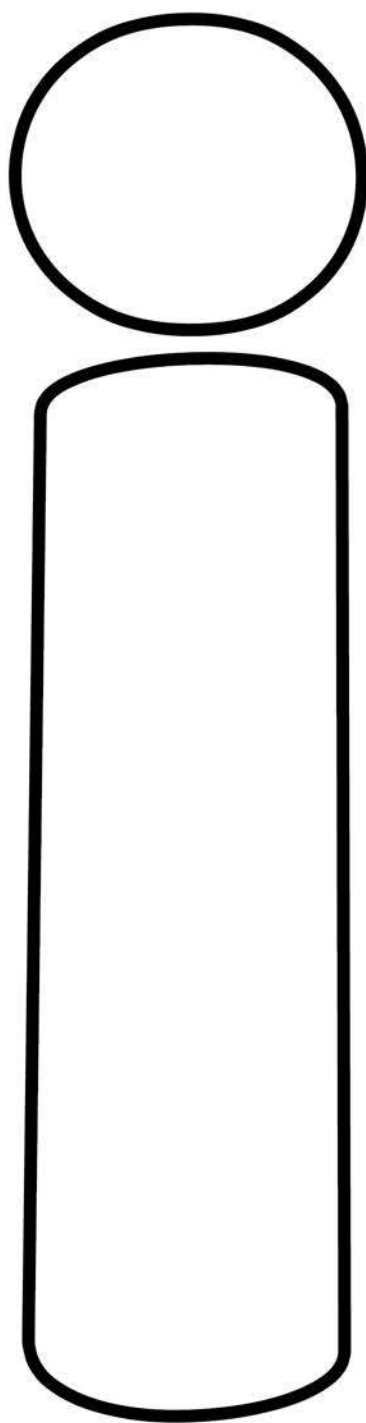

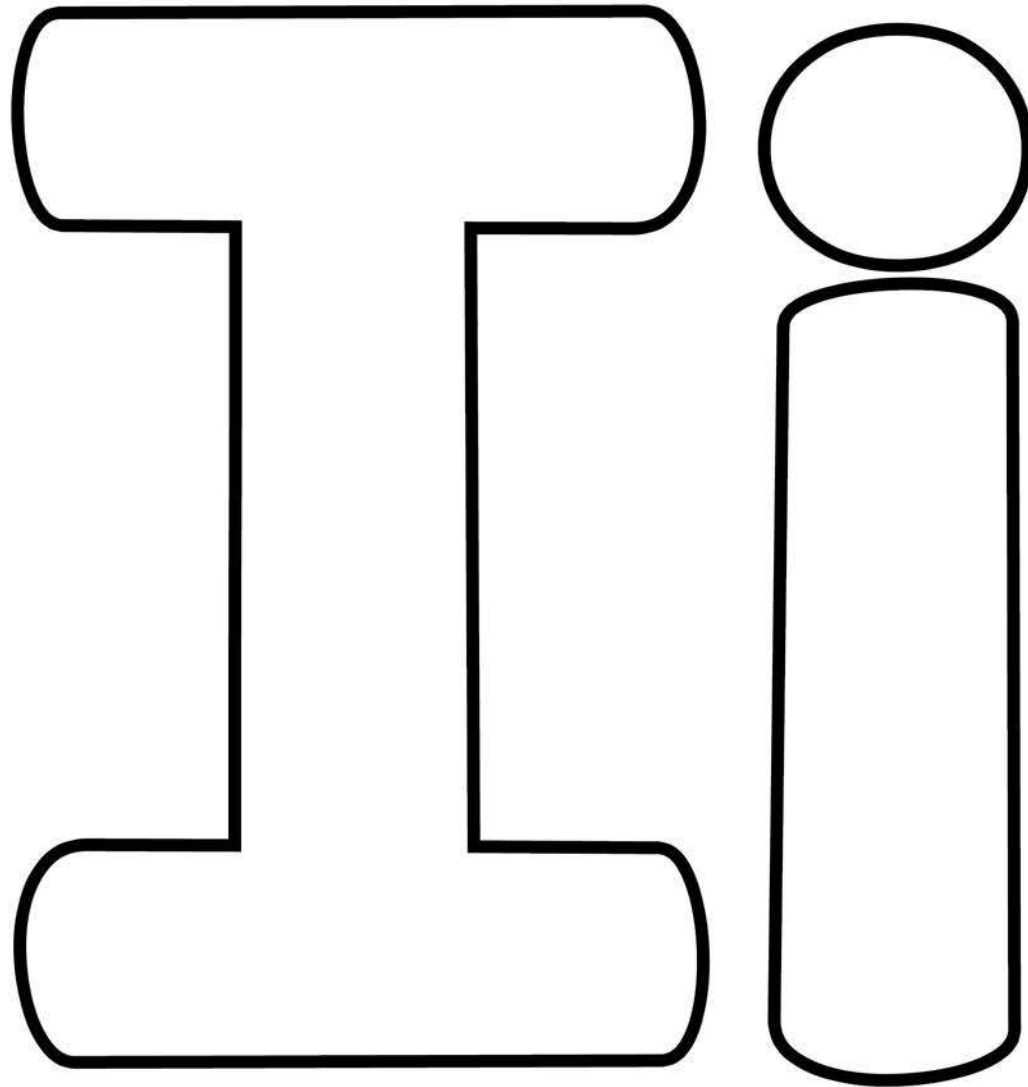

I C A N F I N D

the letter:

B I G F E V I
I F A H I L H G G

J F I
G T P
I X P
Y G Y
G I G
K H L

F I H M I R O F
Q K B F I H E I

n h i
b i l i g

r i
h e f
n o h
i h w
f g l
h i c
i e w
h i g
i o n i

How Many?

How Many?

TRACE

NAME : _____

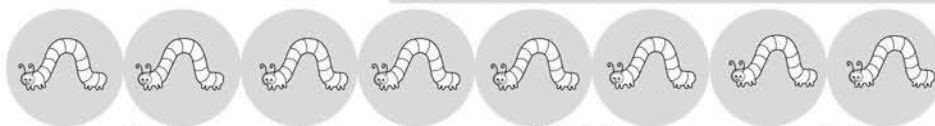

Color one for each row of letters you complete



C O U N T

Counting activity for the letter 'I'. The page contains 15 illustrations of various items: igloos, worms, lizards, cakes, and irons. Each illustration is accompanied by either a large uppercase letter 'I' or a small lowercase letter 'i'. The items are arranged in a scattered pattern across the page.

G R A P H

Graphing activity for the letter 'I'. A 6x7 grid is provided for students to place the items from the counting section. The bottom row of the grid is pre-filled with the following items from left to right: uppercase 'I', lowercase 'i', an igloo, a worm, a lizard, a cake, and an iron. The remaining 5 rows of the grid are empty for the student to place the other items.

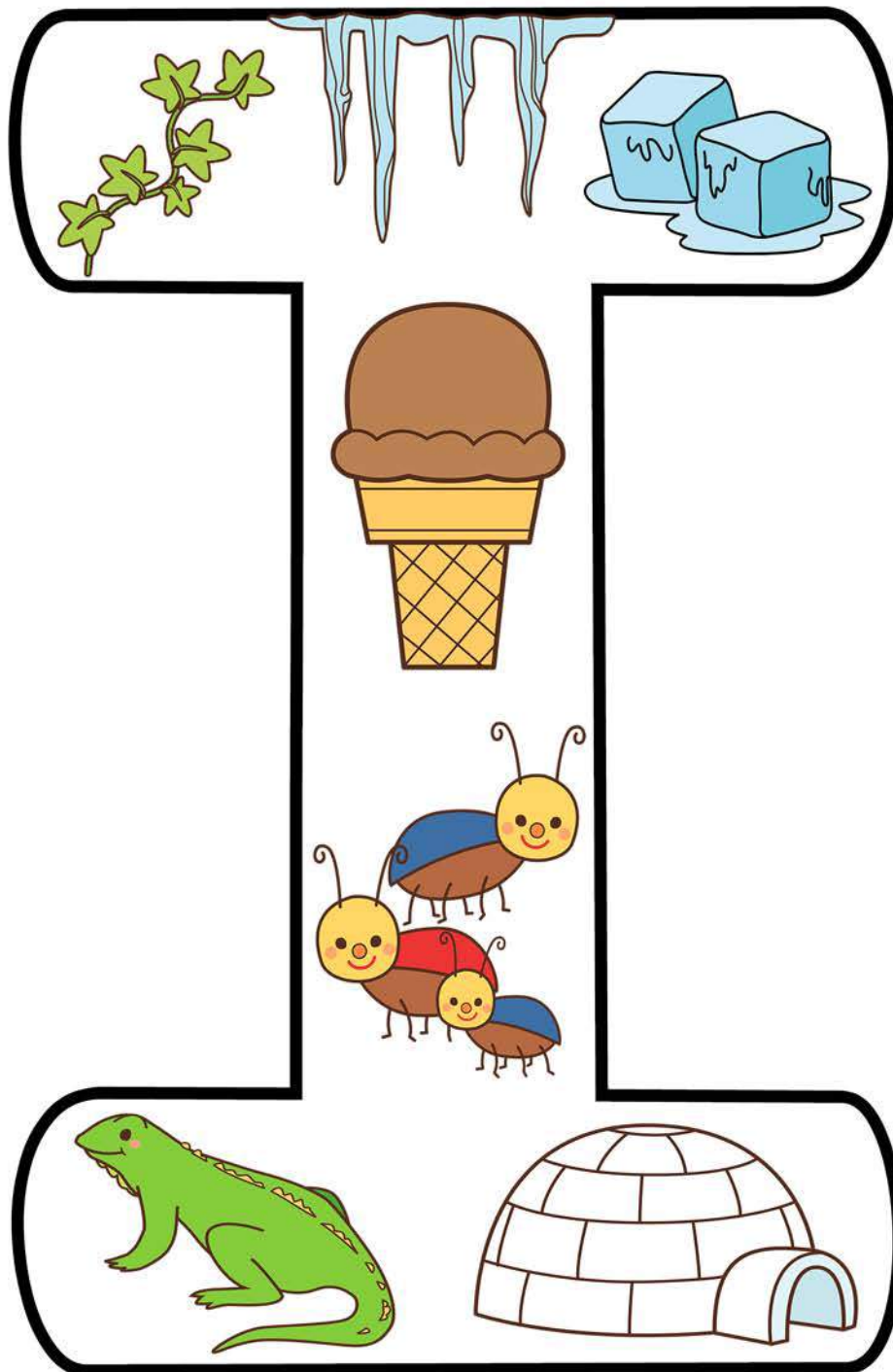

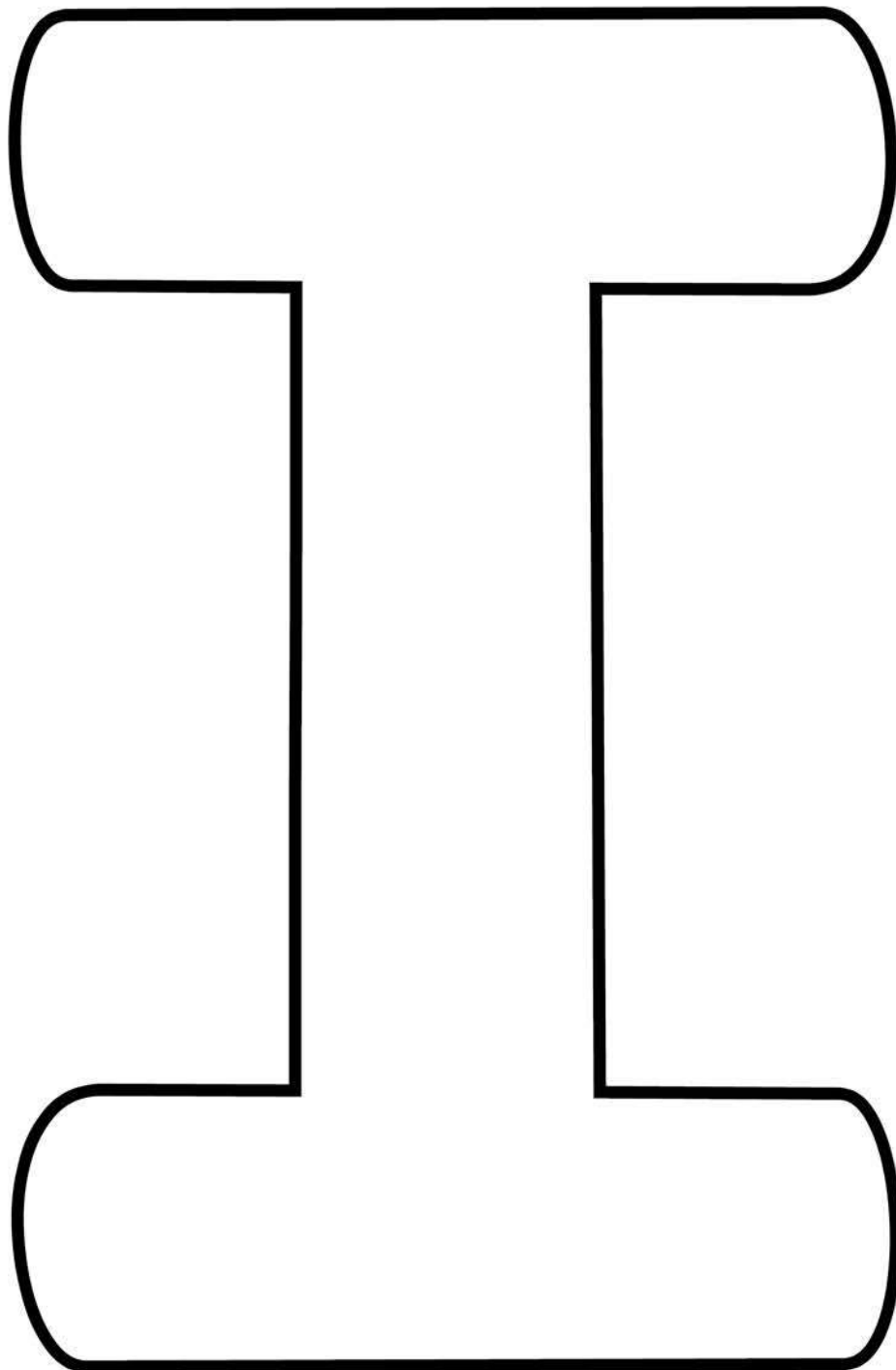

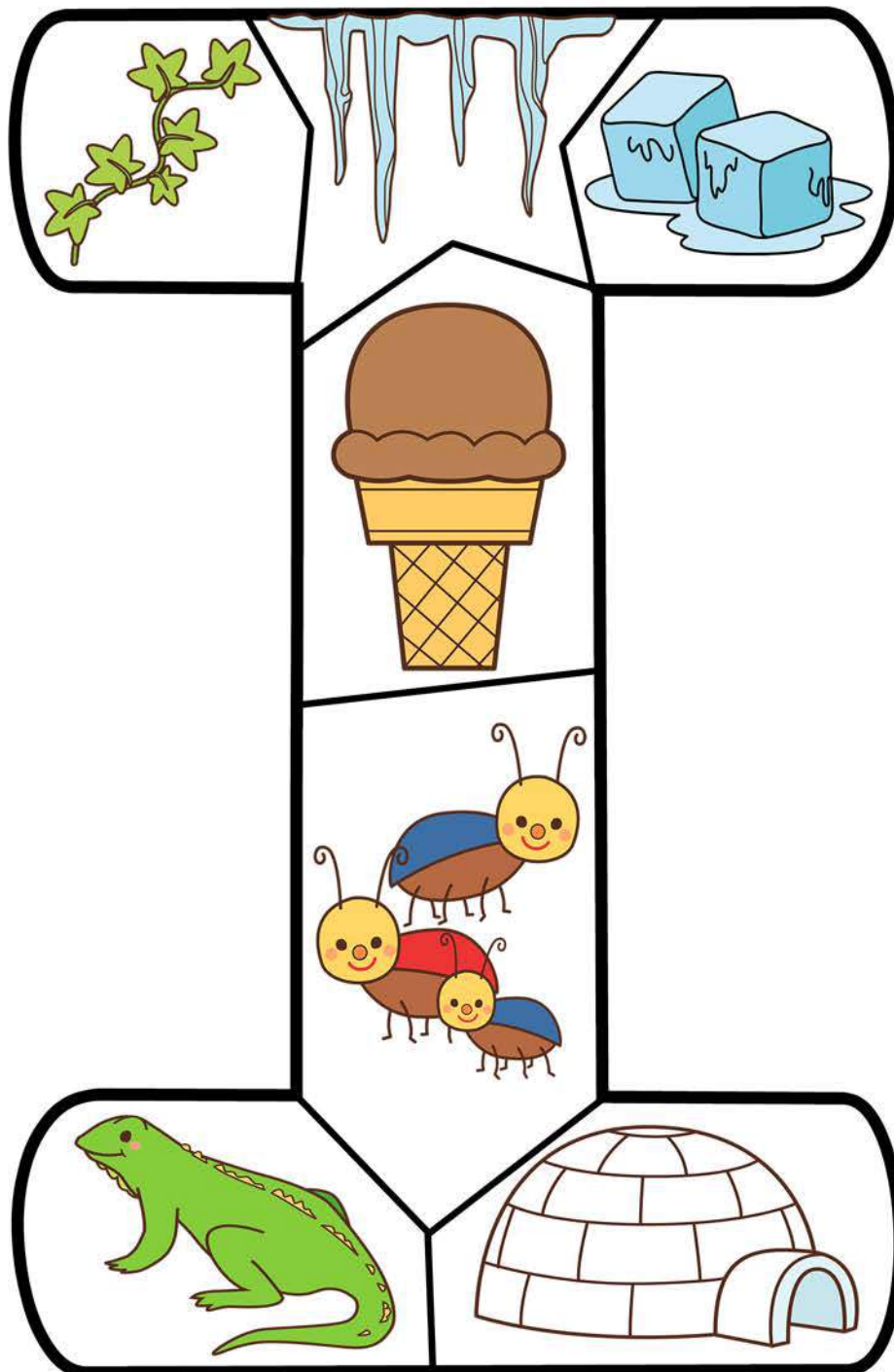

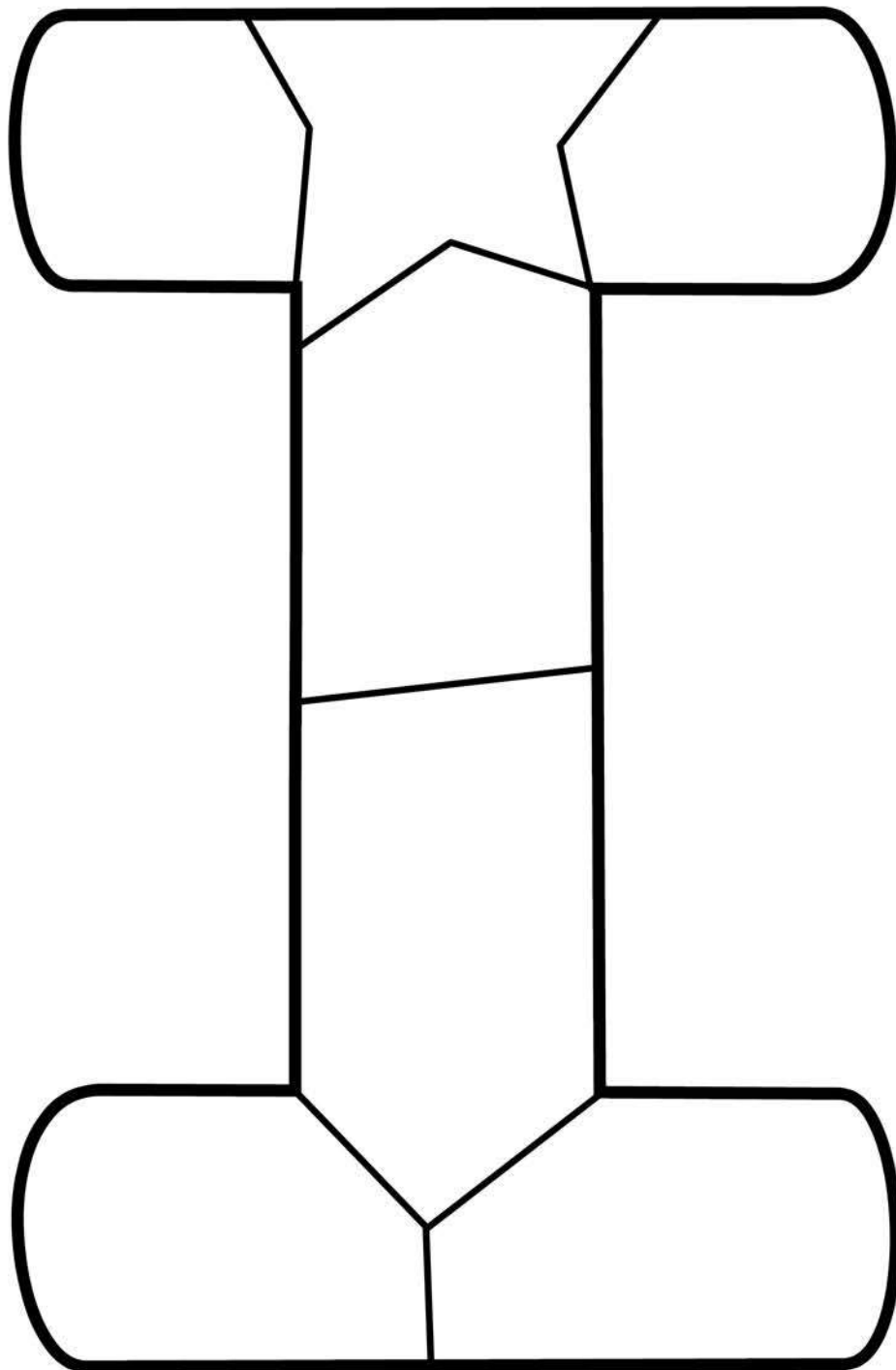

1. Write

2. Cut Out 

NAME : _____

1	1	1
1	1	1
1	1	1
1	1	1
1	1	1
1	1	1
1	1	1
1	1	1
1	1	1
1	1	1

A B C

Q U I L T

3. Color

4. Cut out 

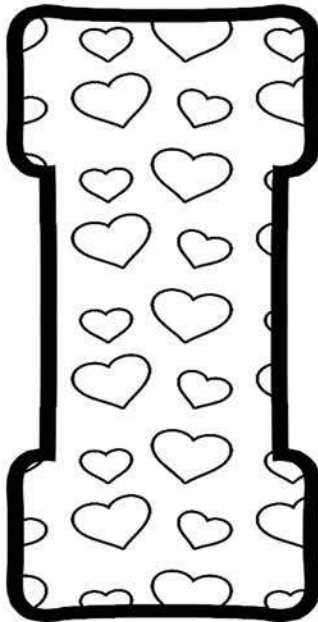
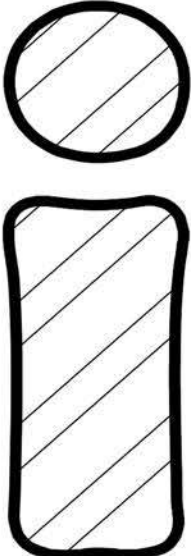
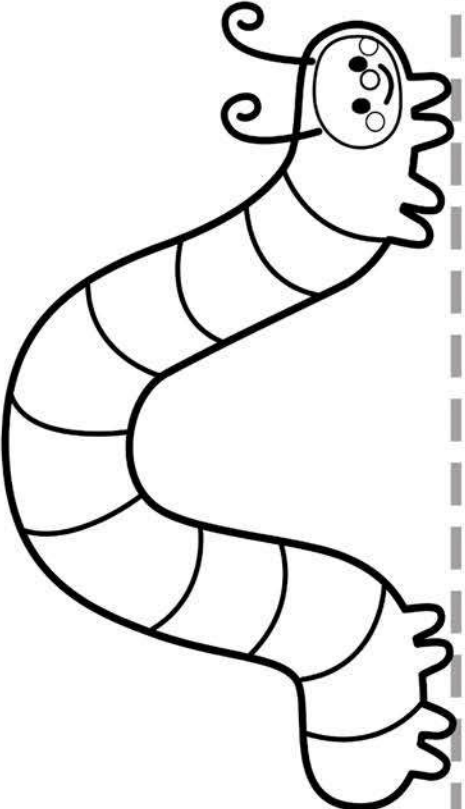
		
NAME : _____		

NAME : _____

Ii

Write and read words that begin with letter i.

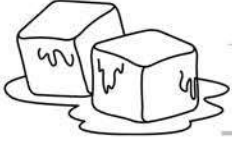

ice ice ice

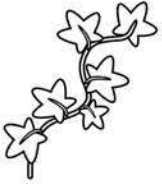

ivy ivy ivy

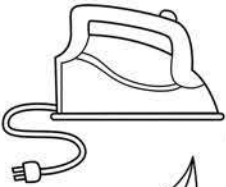

iron iron



ink ink ink

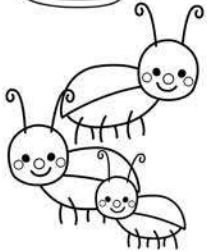

insect insect

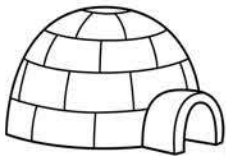

igloo igloo

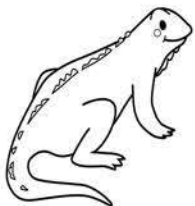

iguana iguana



ivy

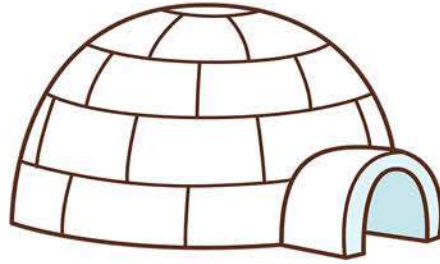

igloo



ice cream

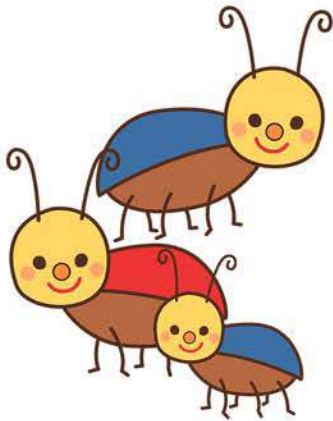

insects

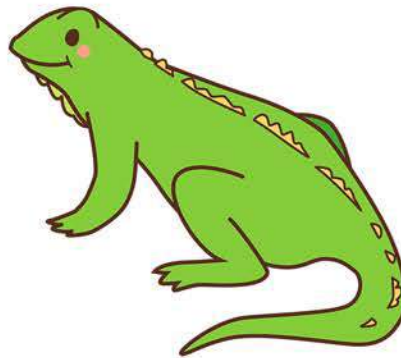

iguana

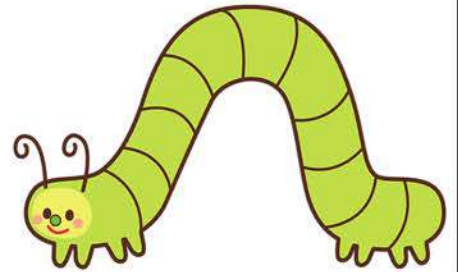

inchworm

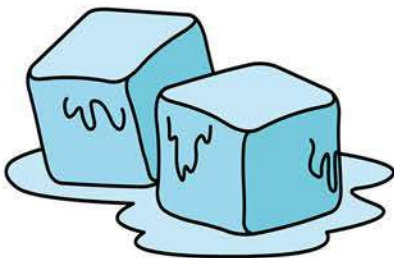

ice

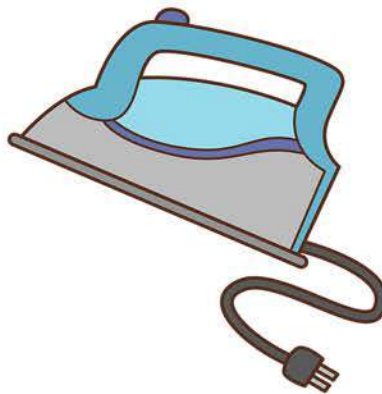

iron





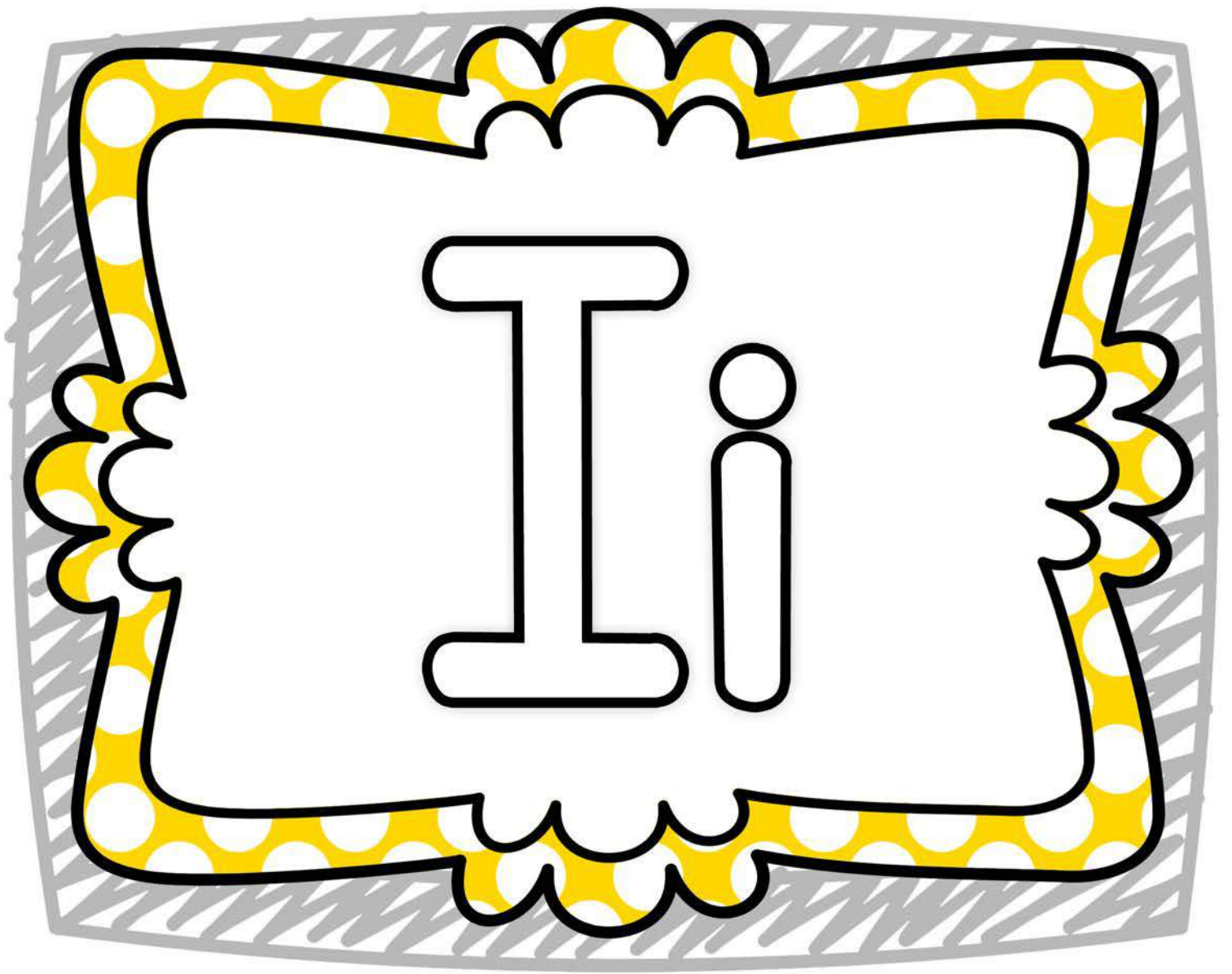







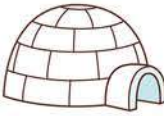

island

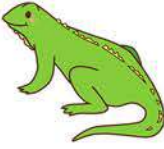
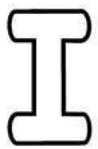
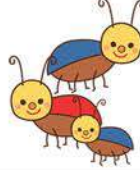

LETTER I

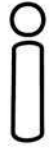















4 IN A ROW

LETTER I

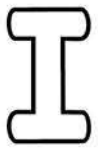
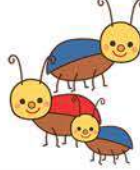

4 IN A ROW

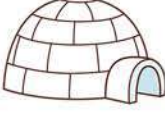
LETTER I



4 IN A ROW

LETTER I



4 IN A ROW

I C A N W R I T E

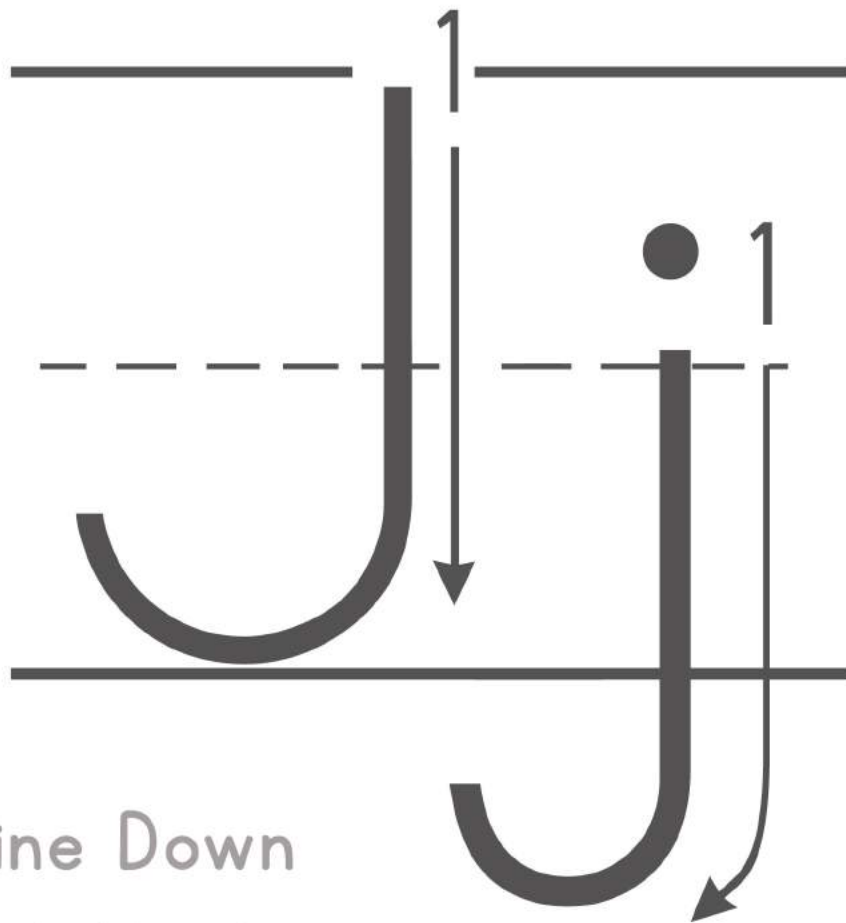

Line Down
But First
Come Back
Around

Line Down
Below
A Tail Will Grow
Dot on Top

Jellyfish

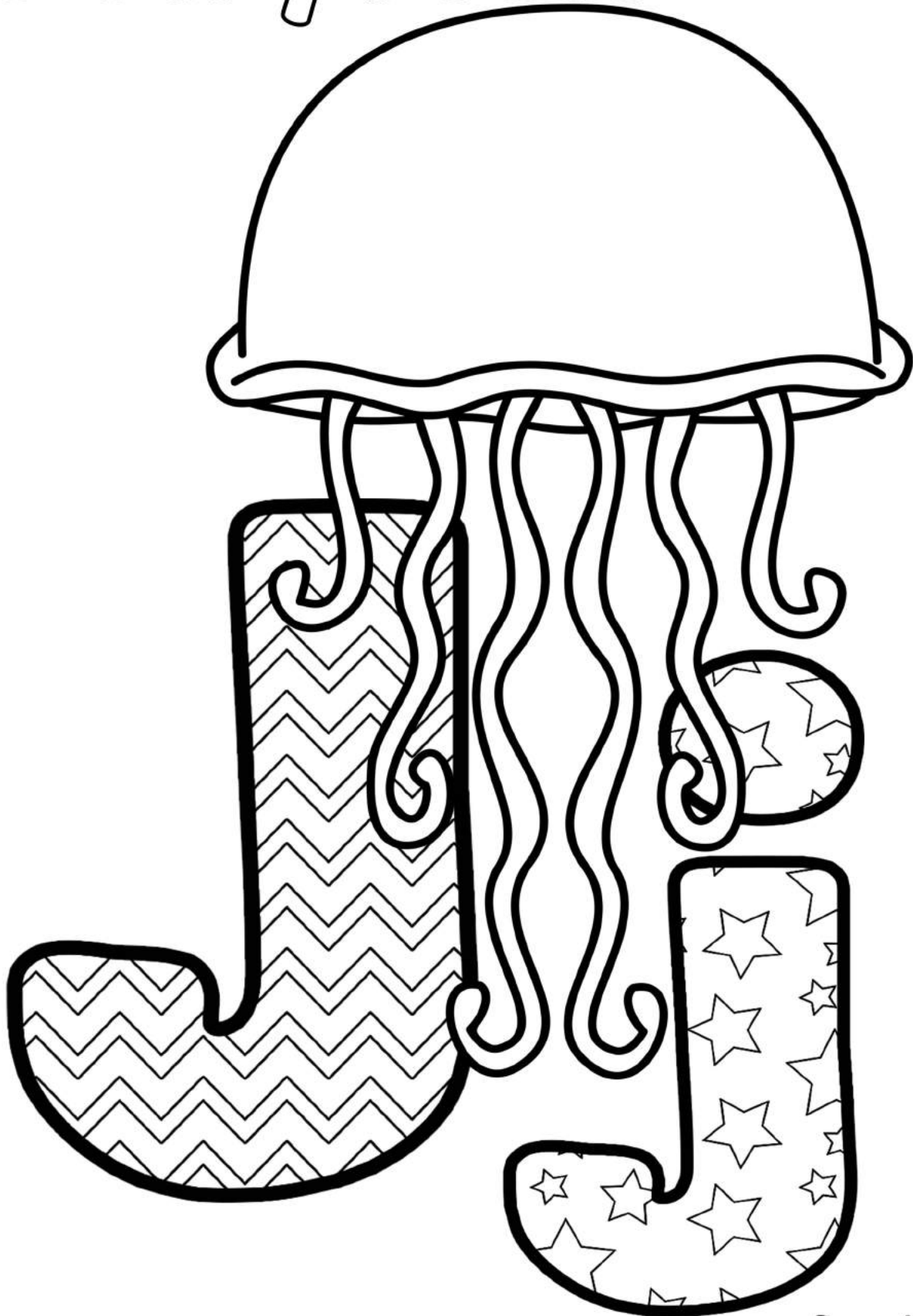

J j

J j

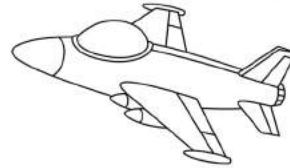
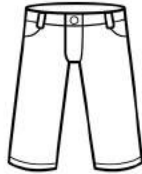

jam

jester

jeans

jellyfish

jet

jar

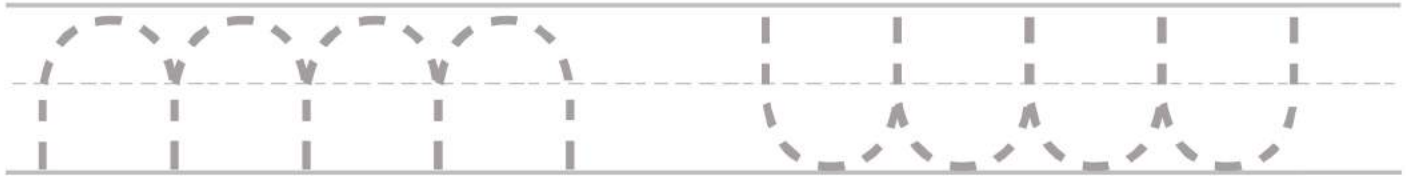

Give the jellyfish eleven tentacles:



Which label would fit best?

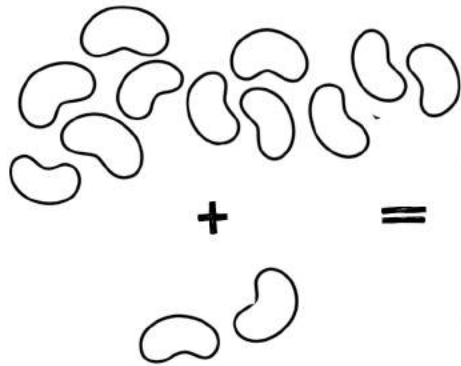
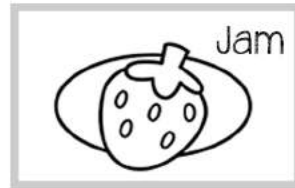

Add



Count & Tally the grey pearls:

$$|| + | = \square$$

$$|| + 2 = \square$$

$$\begin{array}{r} 2 \\ + 11 \\ \hline \square \end{array} \quad \begin{array}{r} 11 \\ + 2 \\ \hline \square \end{array}$$

Draw four jellybeans inside the jar.
Draw seven jellybeans outside the jar.



Circle the small jellybeans, X out the large, and color the medium.

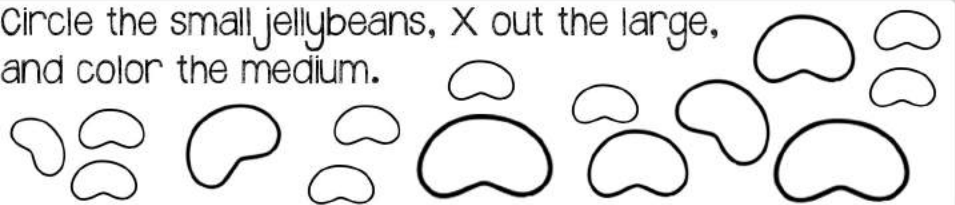

Draw: $|| + | = 12$
 $+ =$

Jj

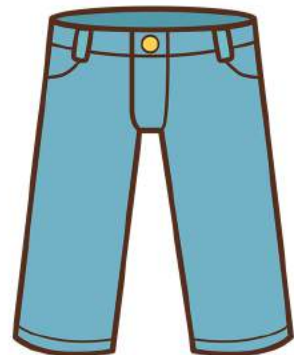
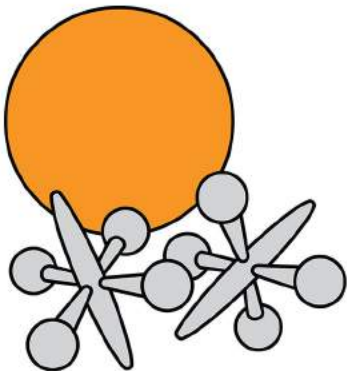
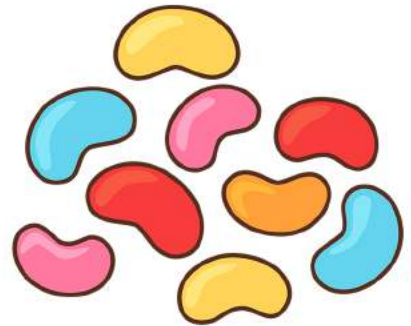
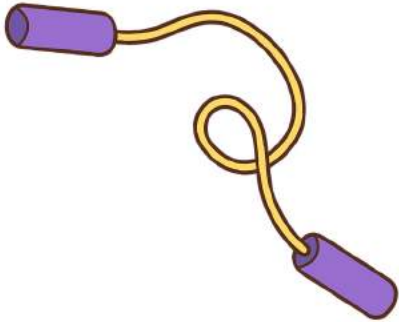
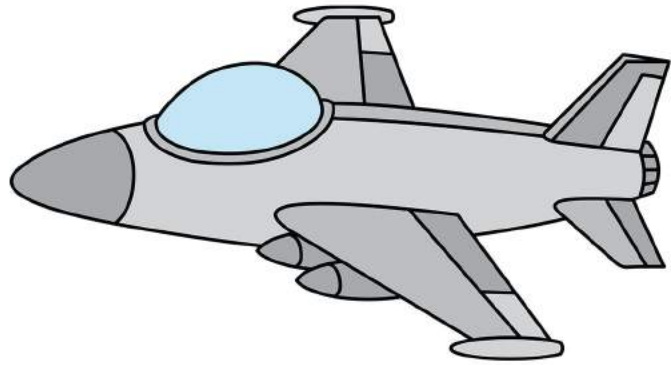

I

C * A * N *

C * O * L * O * R *

words with:

● = jam

● = jumprope

● = jeans

● = jelly beans

● = jet

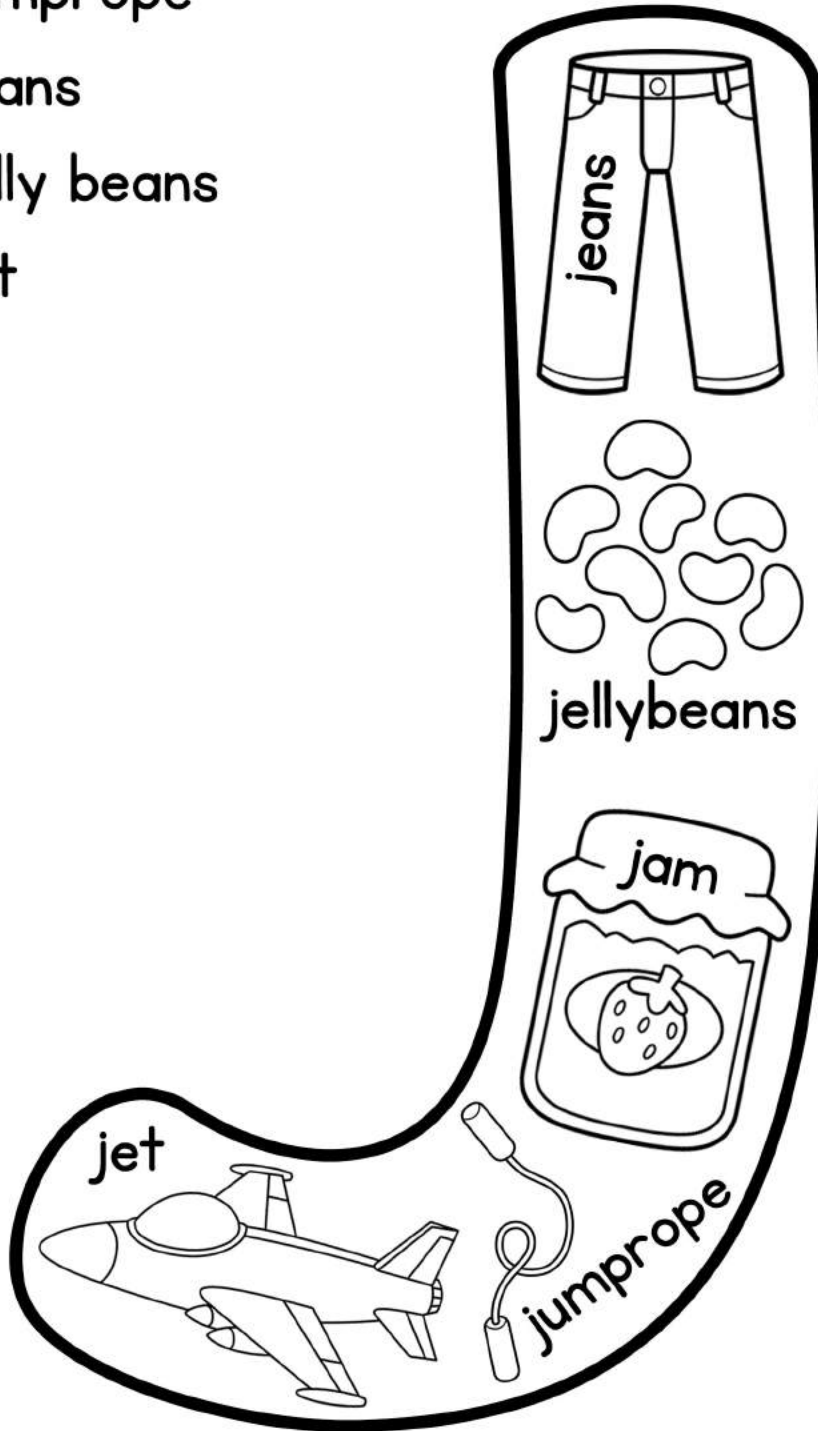

NAME : _____

Jj

Write and read words that begin with letter j.



jam jam jam



jar jar jar

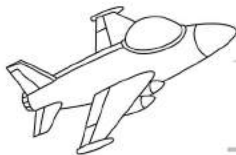

jet jet jet



juice juice

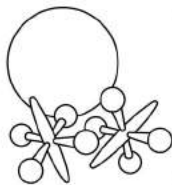

jacks jacks



jeans jeans

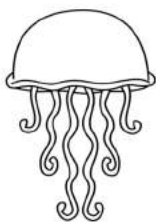

jellyfish

NAME : _____

Jj

Write and read words that begin with letter j.



Jam Jam Jam



Jar Jar Jar

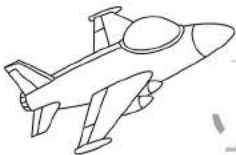

Jet Jet Jet



Juice Juice

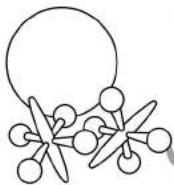

Jacks Jacks



Jeans Jeans



Jellyfish

NAME : _____

RACE TO THE TOP

Use a paperclip and a pencil to complete the spinner.

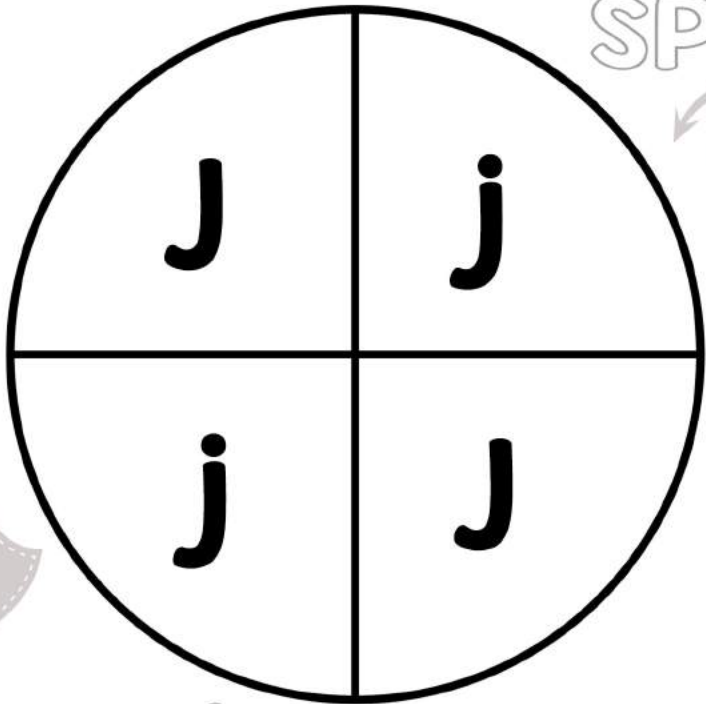

SPIN

Record

Report:

How many spins landed on J?

How many spins landed on j?

Which had more?

Write an inequality: >

How many spins total?

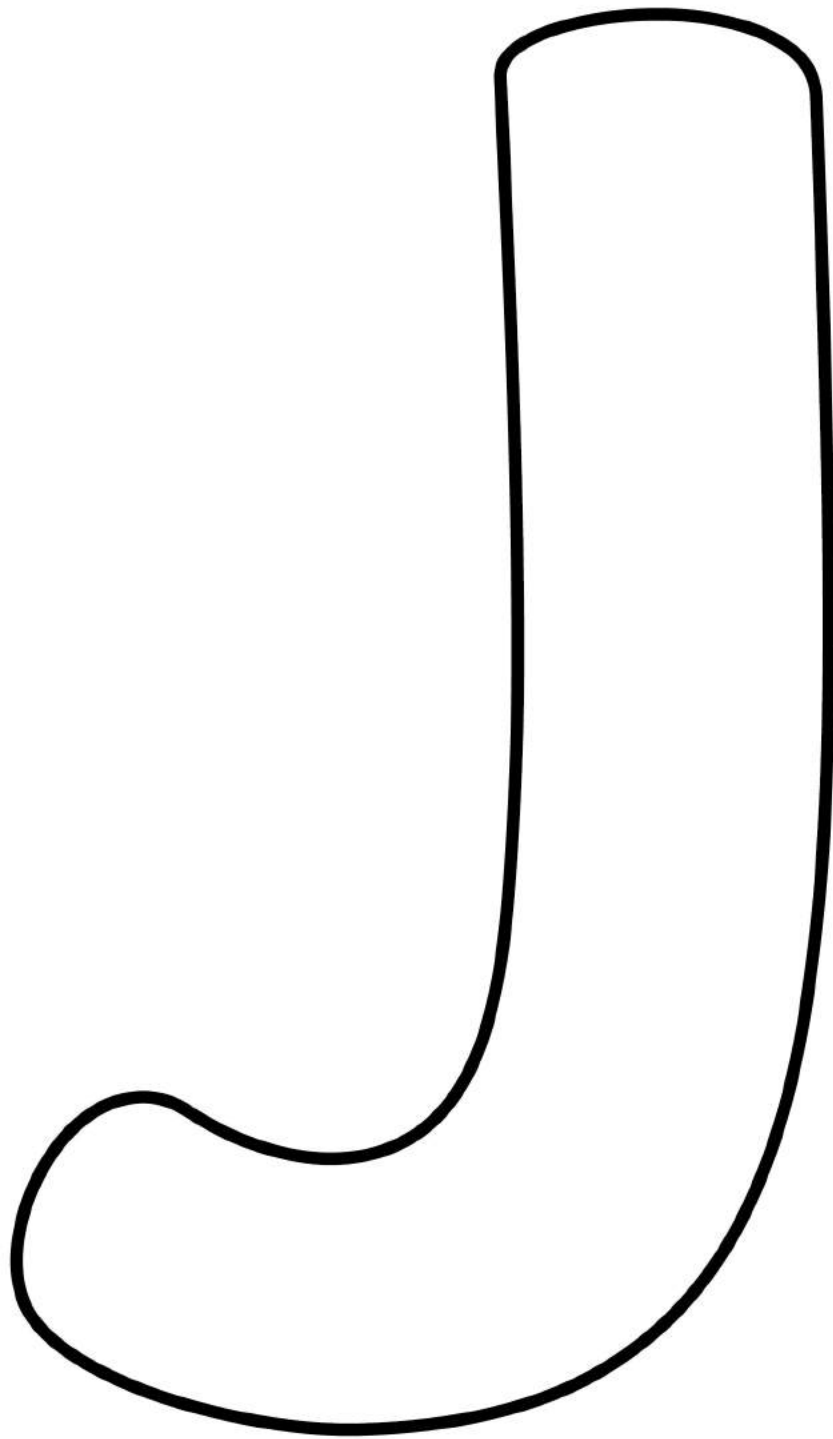

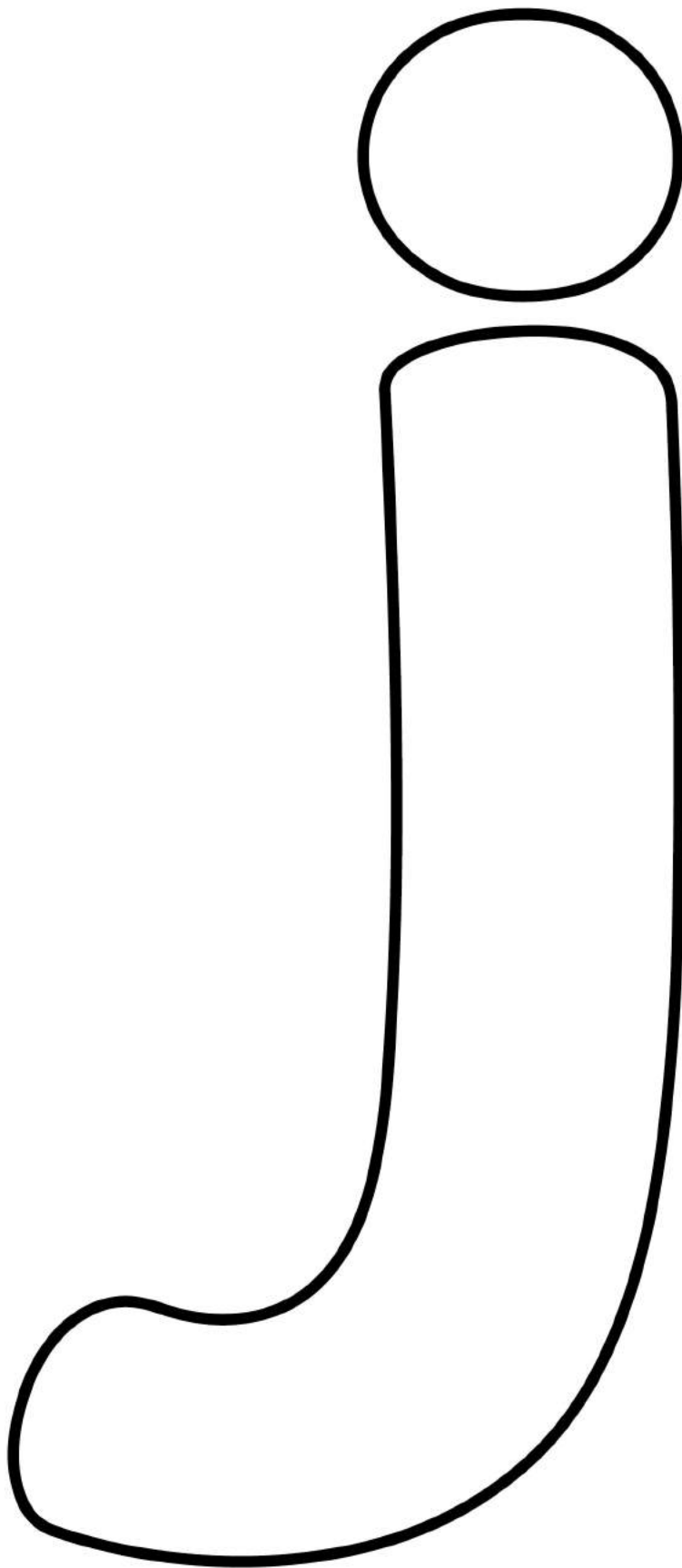

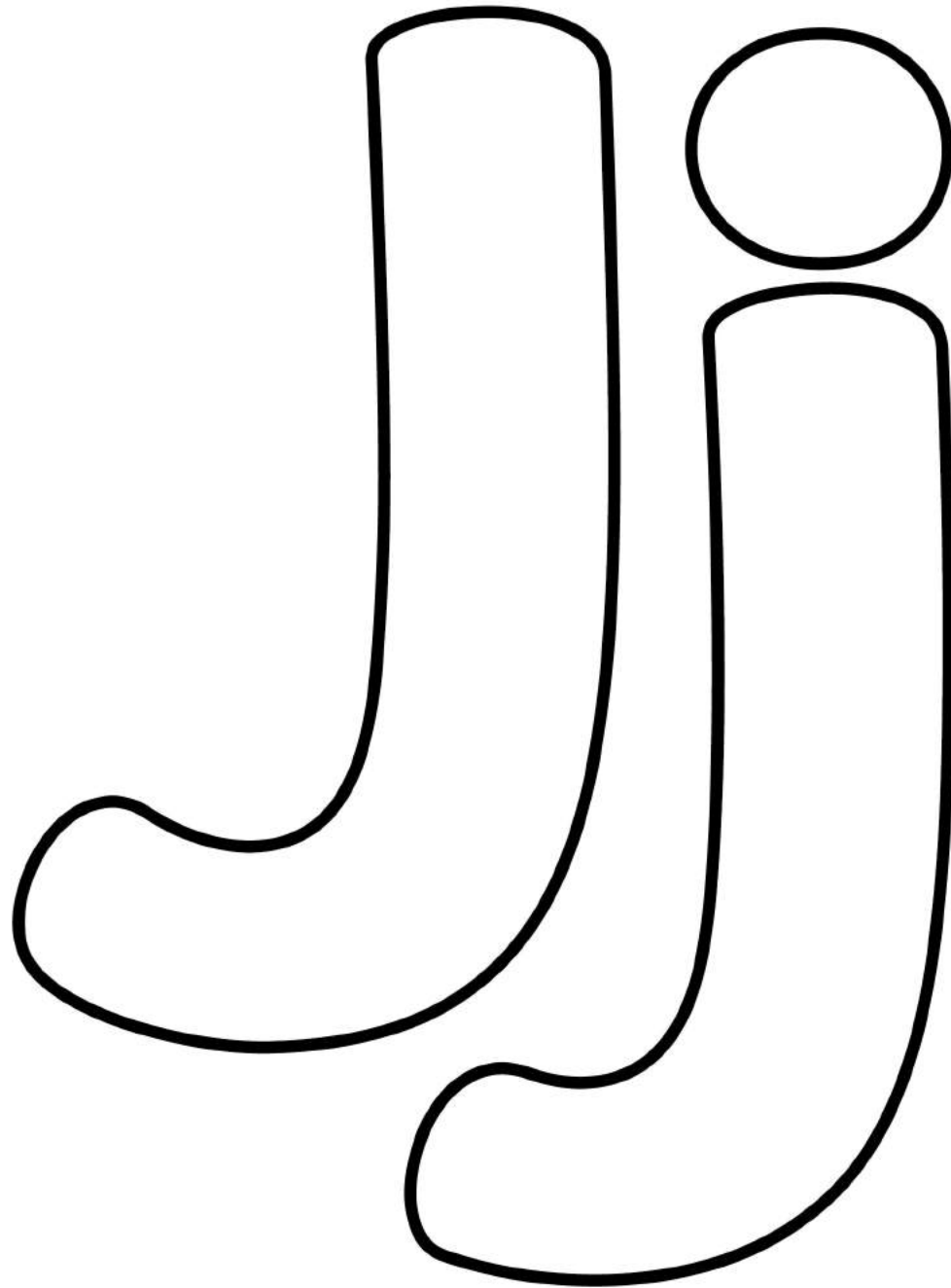

★ I ★

★ C ★ ★ A ★ ★ N ★

★ F ★ ★ I ★ ★ N ★ ★ D ★

the letter:

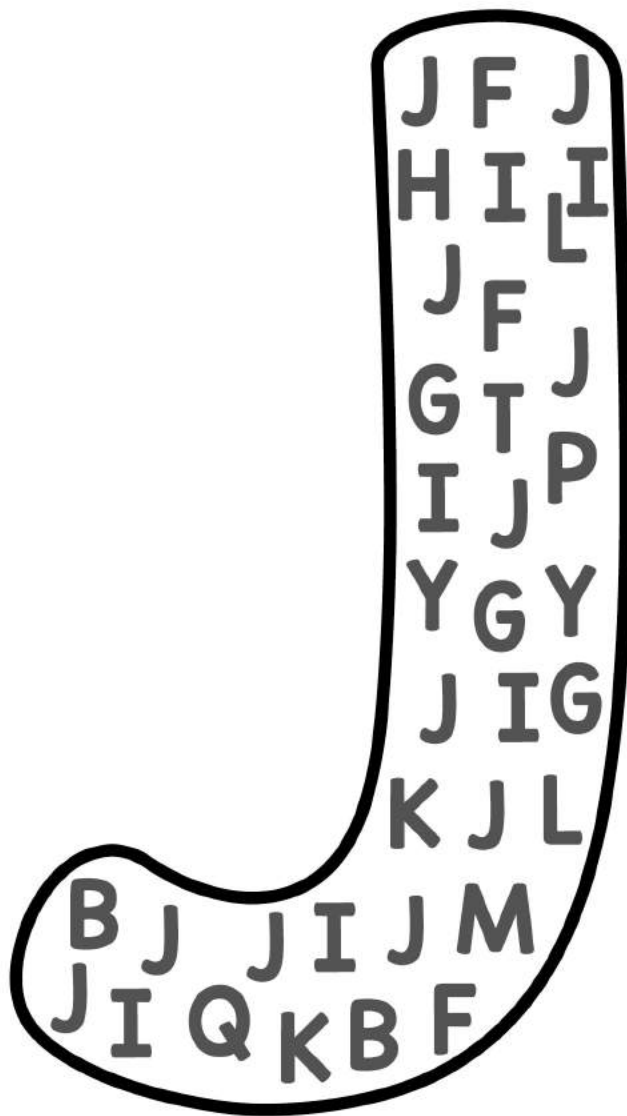

How Many?

How Many?

TRACE

NAME : _____







Color one for each row of letters you complete

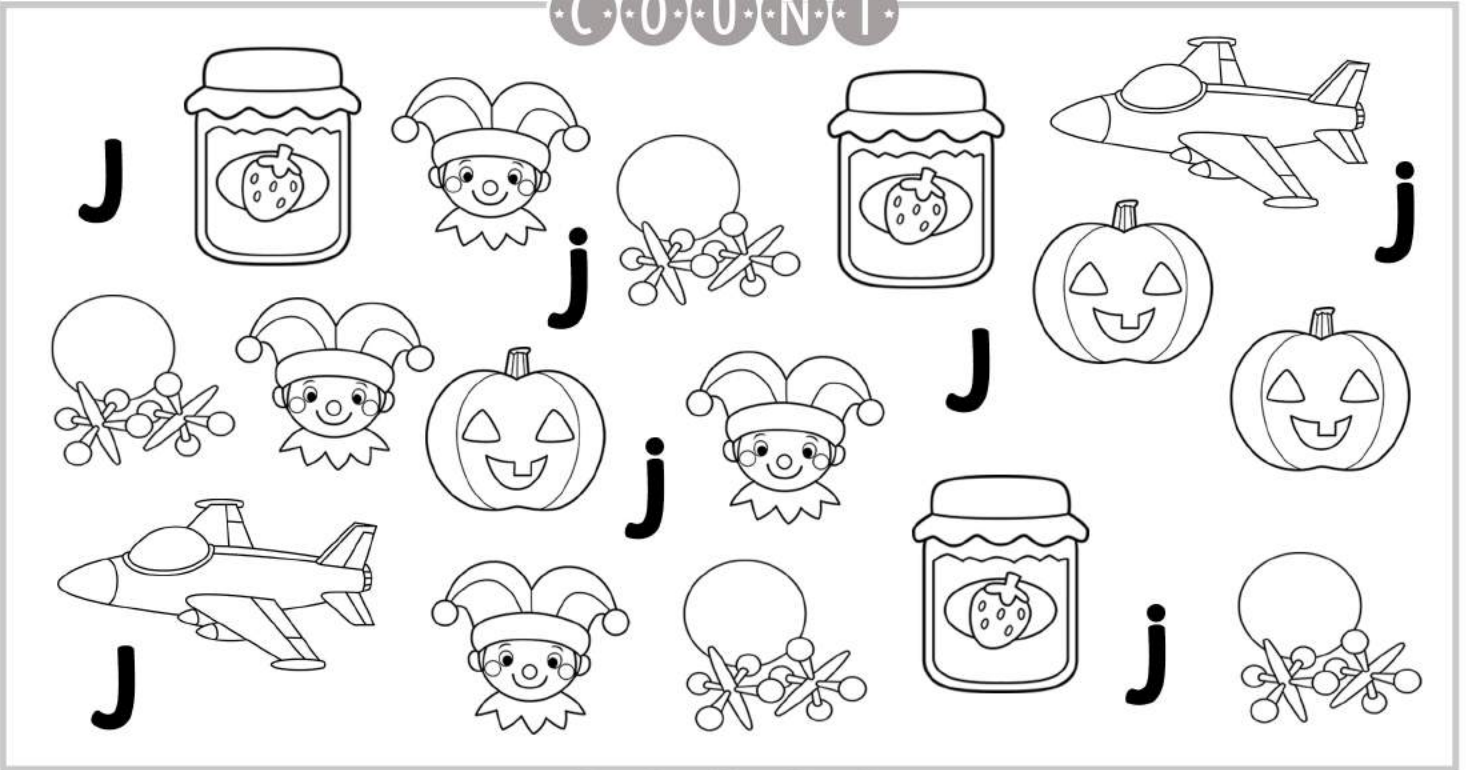

C · O · U · N · T

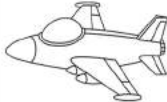

G · R · A · P · H

J	j					

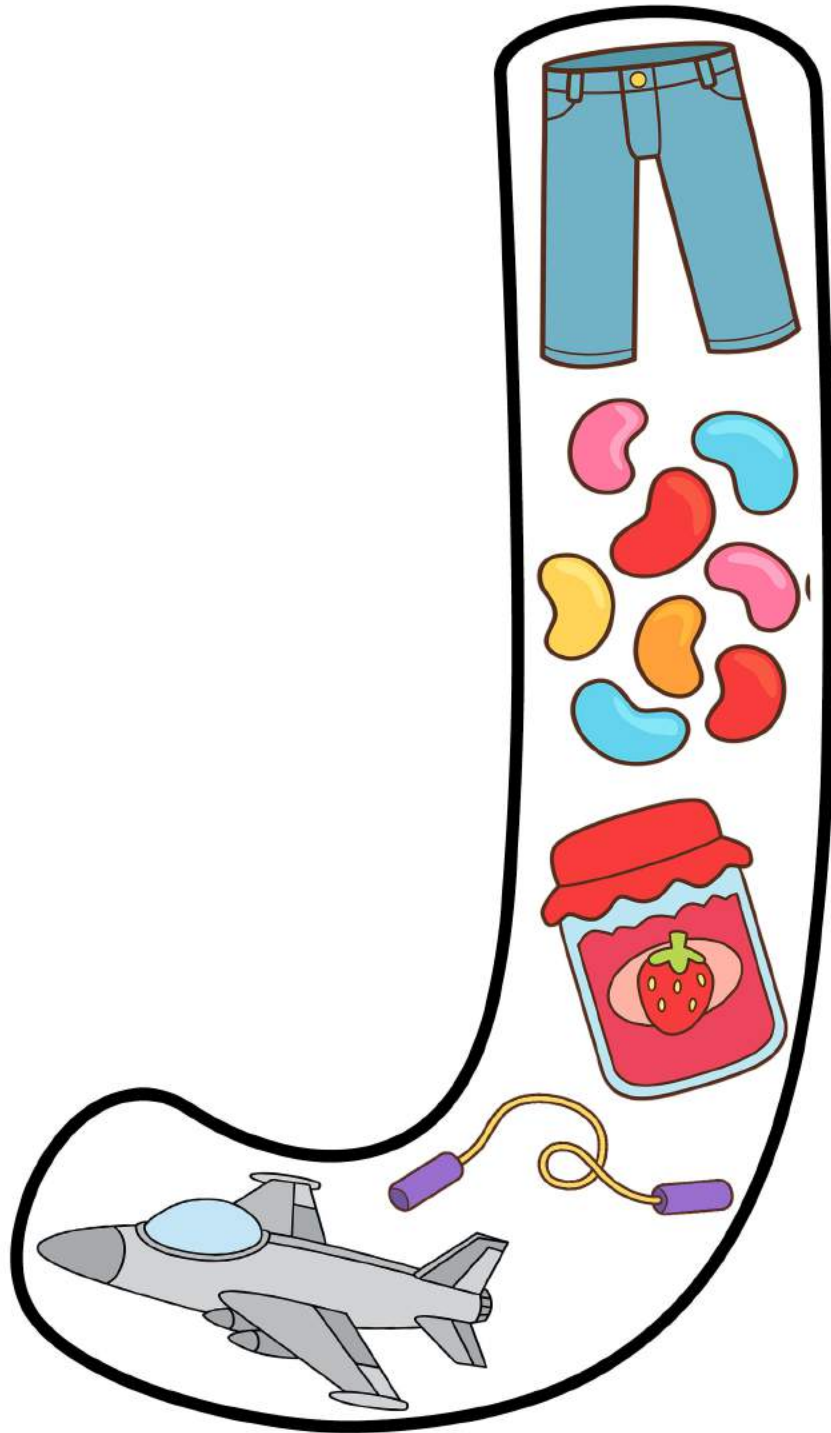

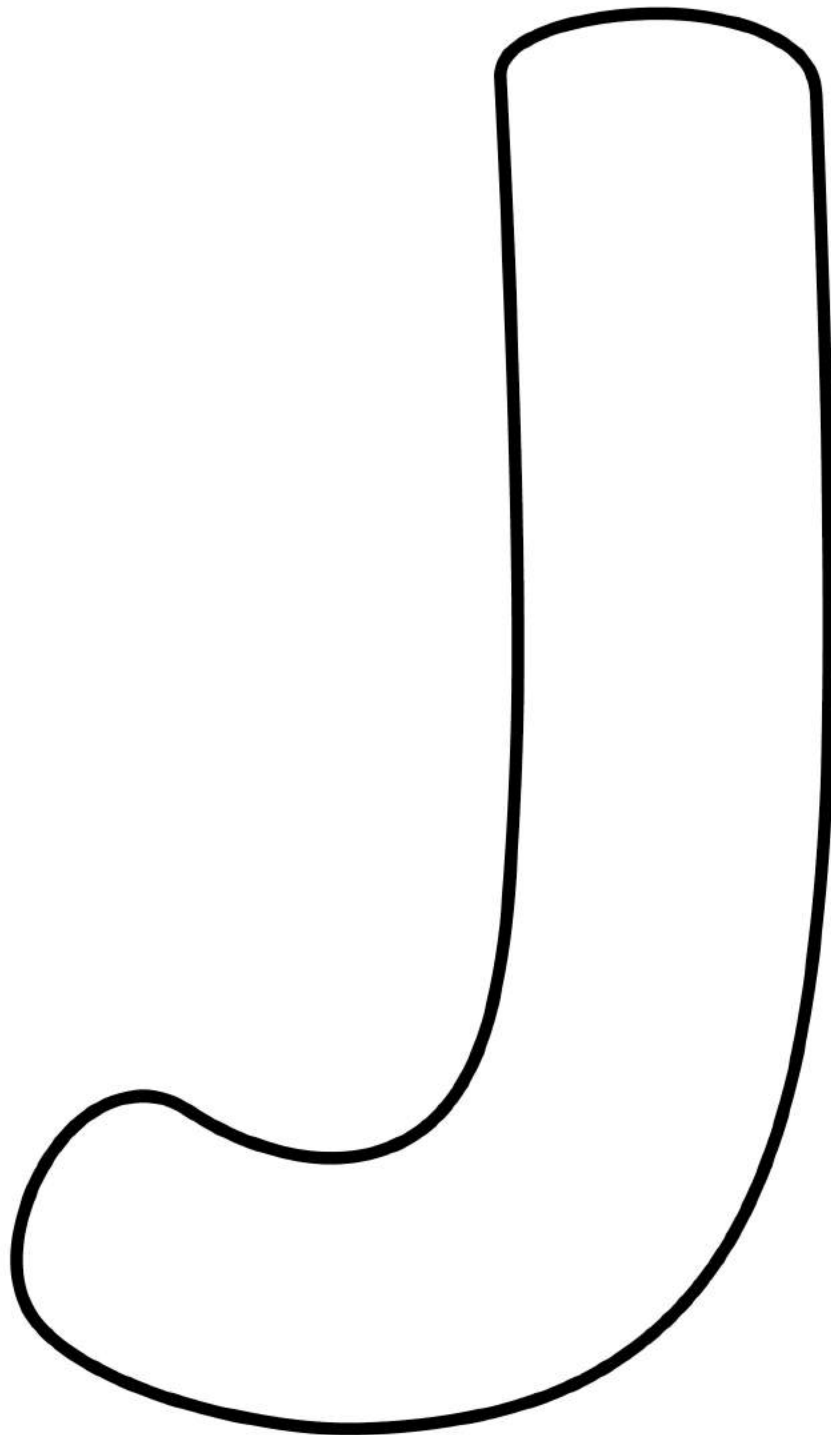

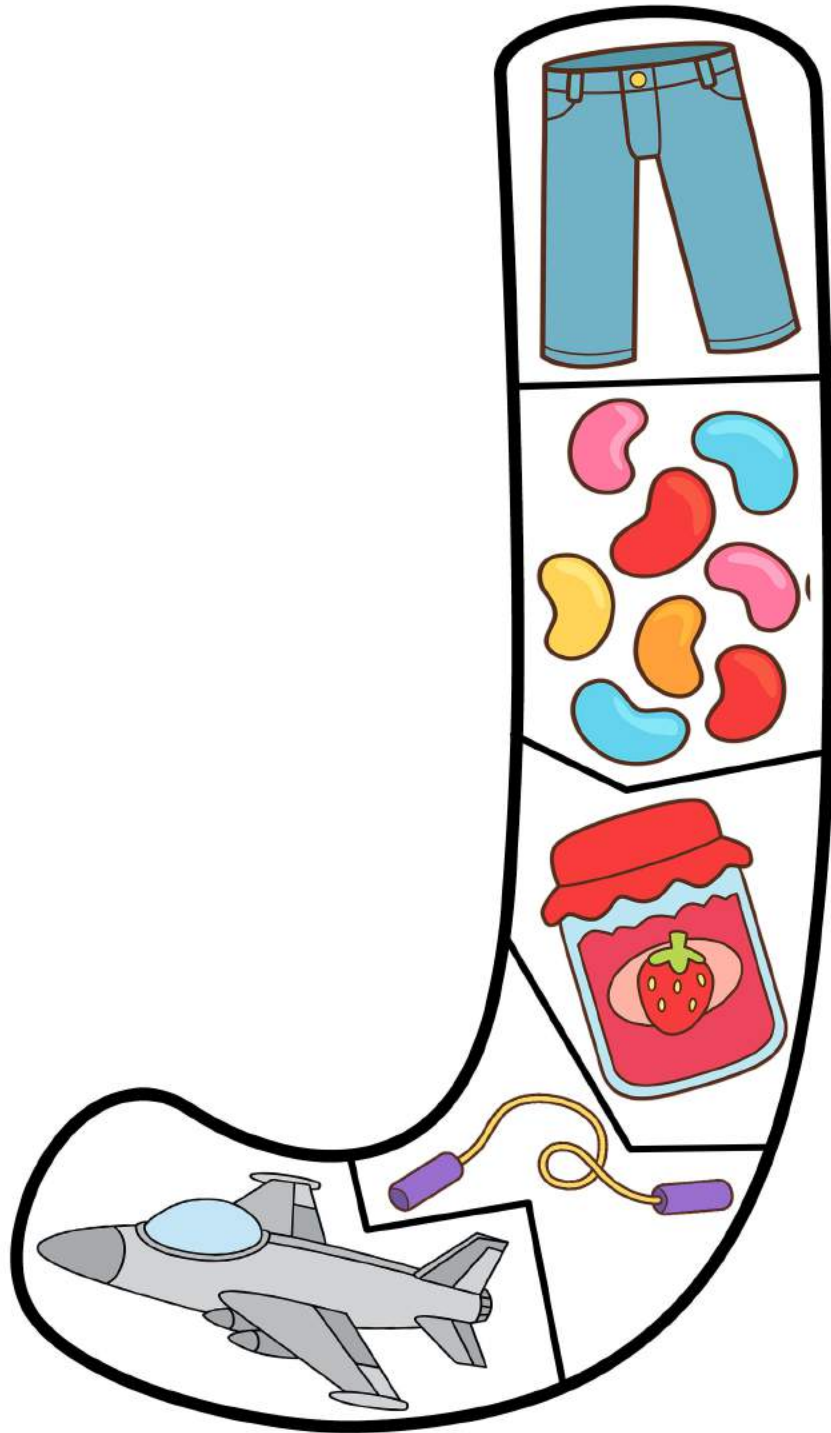

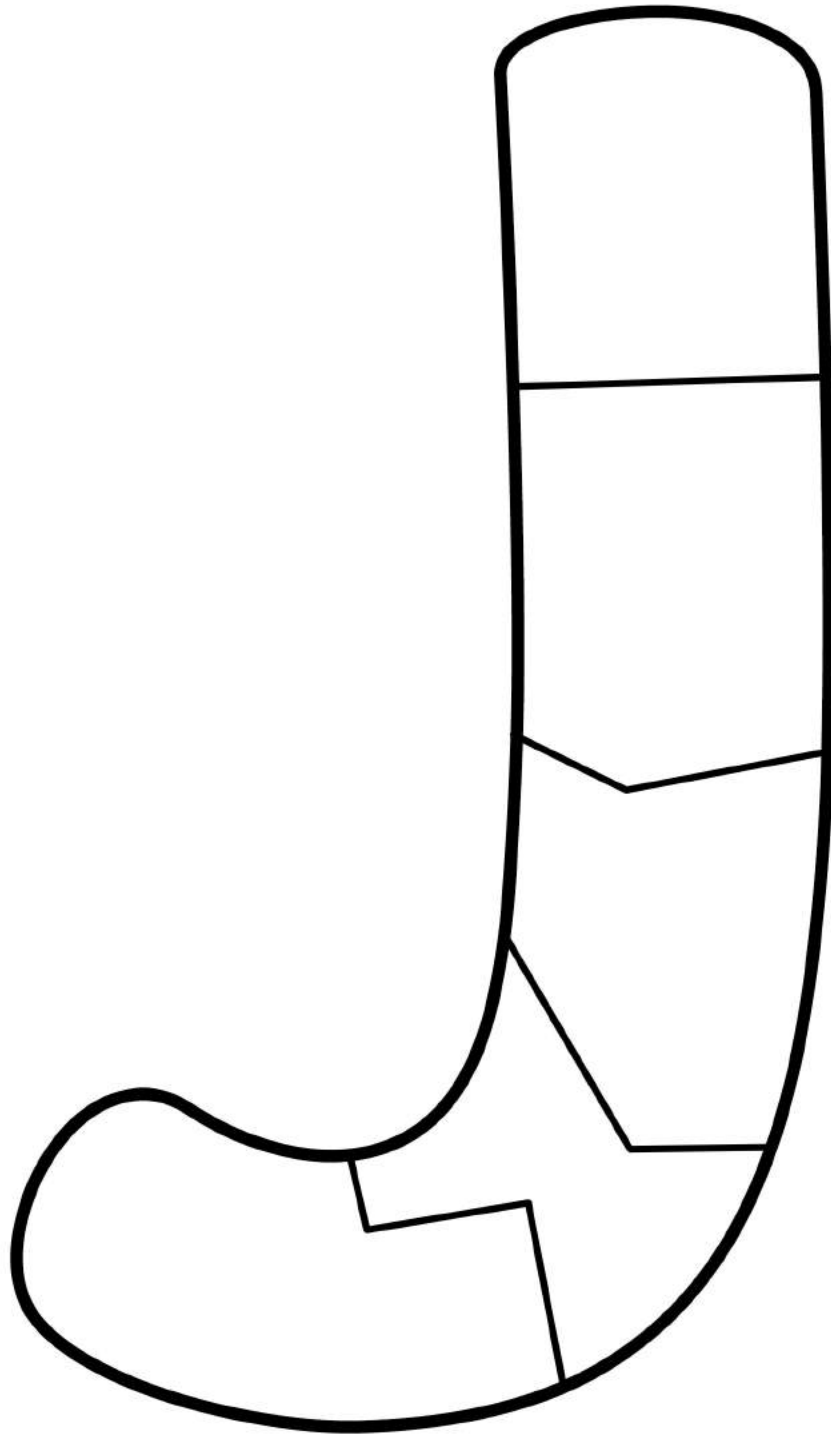

1. Write

2. Cut Out 

NAME : _____

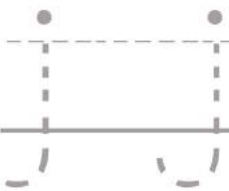
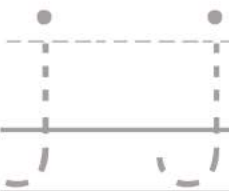

A B C Q U I L T

3. Color

4. Cut out 

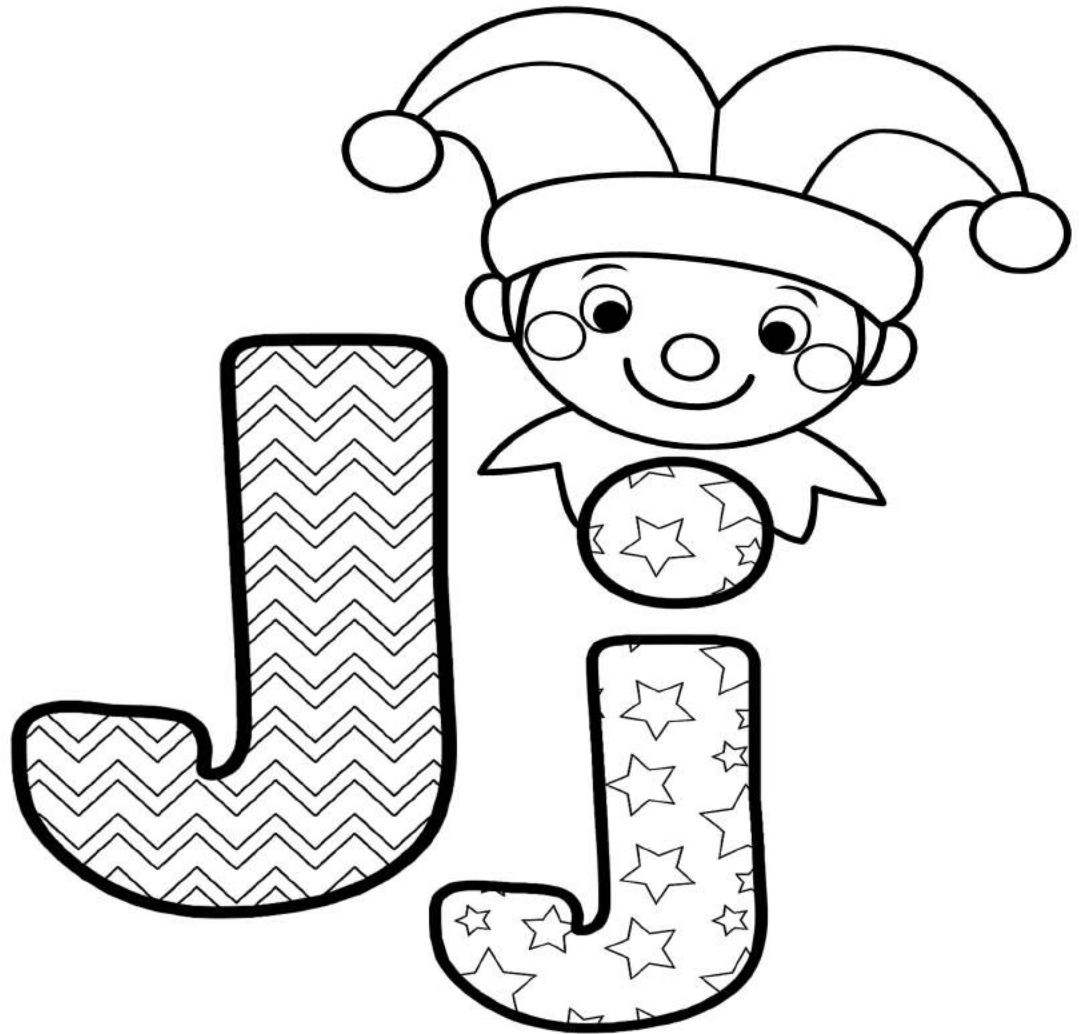

NAME : _____

NAME : _____

Jj

Write and read words that begin with letter j.



jam jam jam



jar jar jar

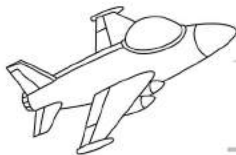

jet jet jet



juice juice

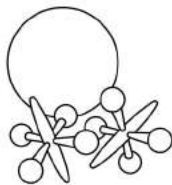

jacks jacks



jeans jeans



jellyfish

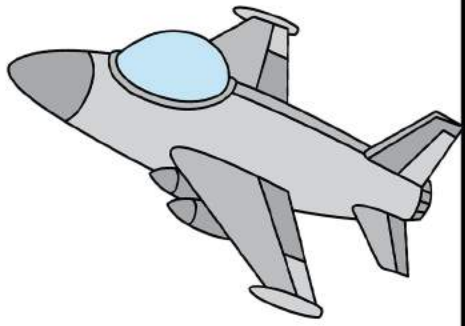

jet



jug



jar



jewelry

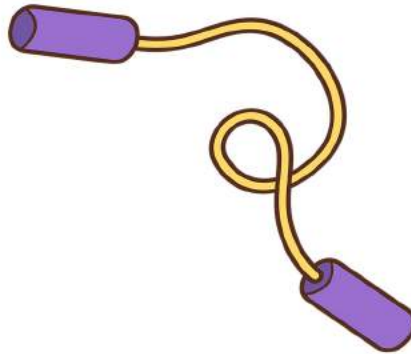

jump rope

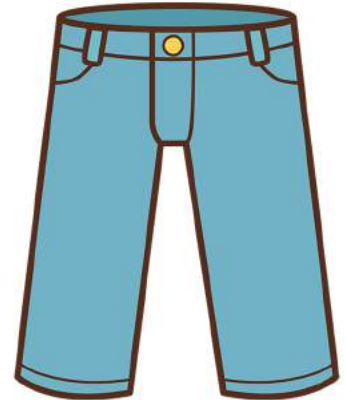

jeans

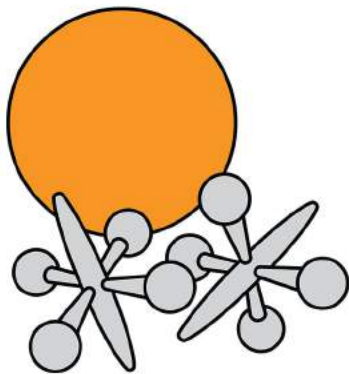

jacks

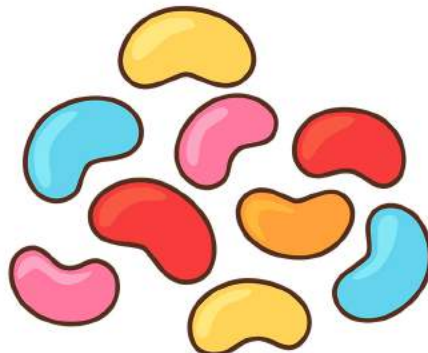

jelly beans



jam

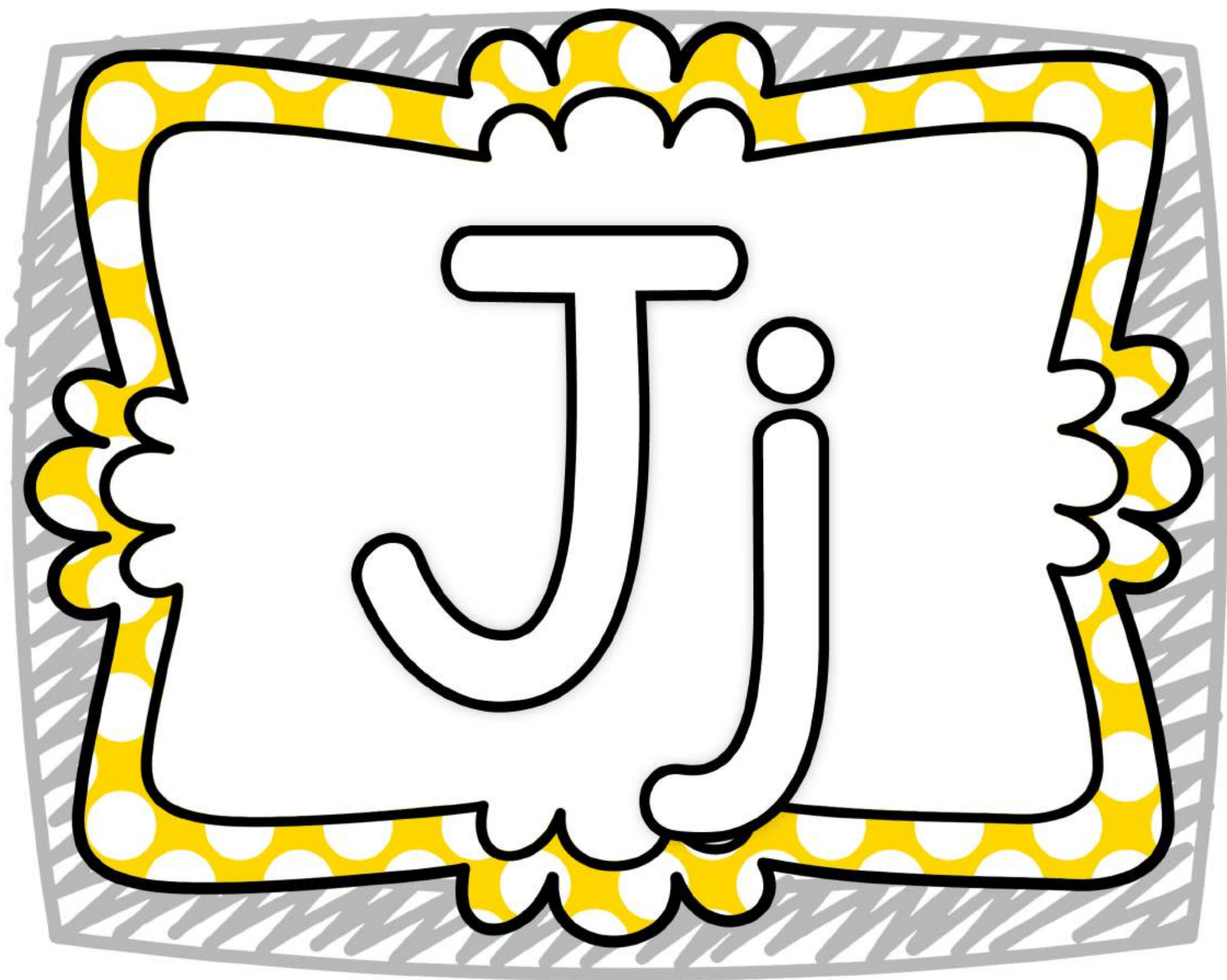

LETTER J



4 IN A ROW

LETTER J



4 IN A ROW

Images (c) Little Red's Clipart, Zip-a-De-Doo-Dah Designs & Miss Giraffe

LETTER J



4 IN A ROW

LETTER J



4 IN A ROW

I C A N W R I T E

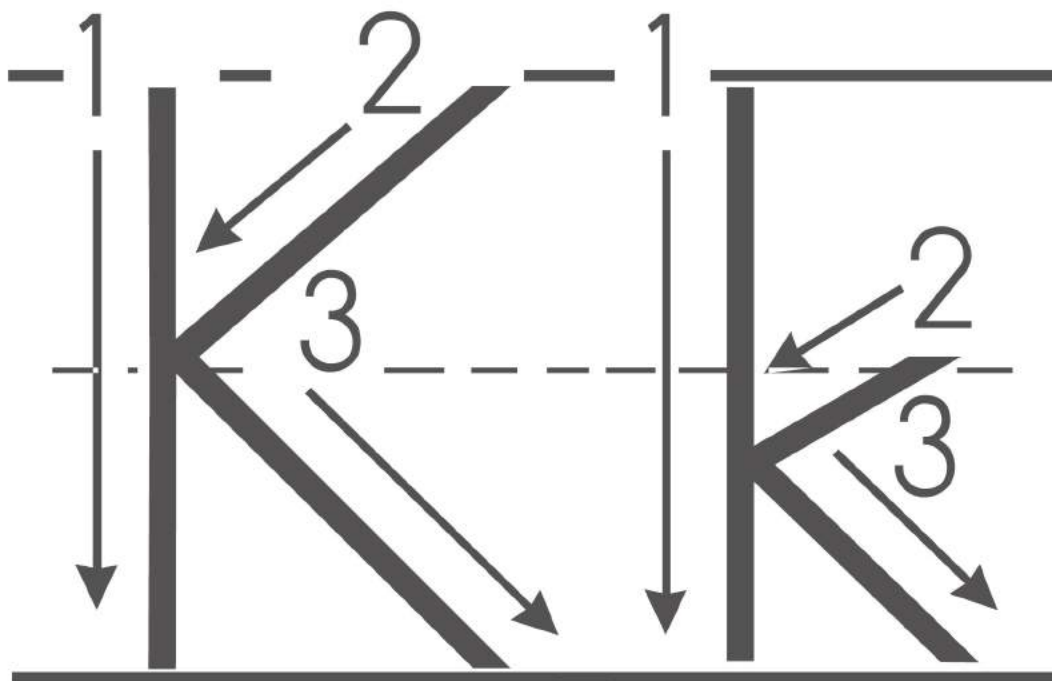

Line Down

Pick Up

Kick In

Kick Out

Line Down

Pick Up

Little Kick In

Little Kick Out

Kite

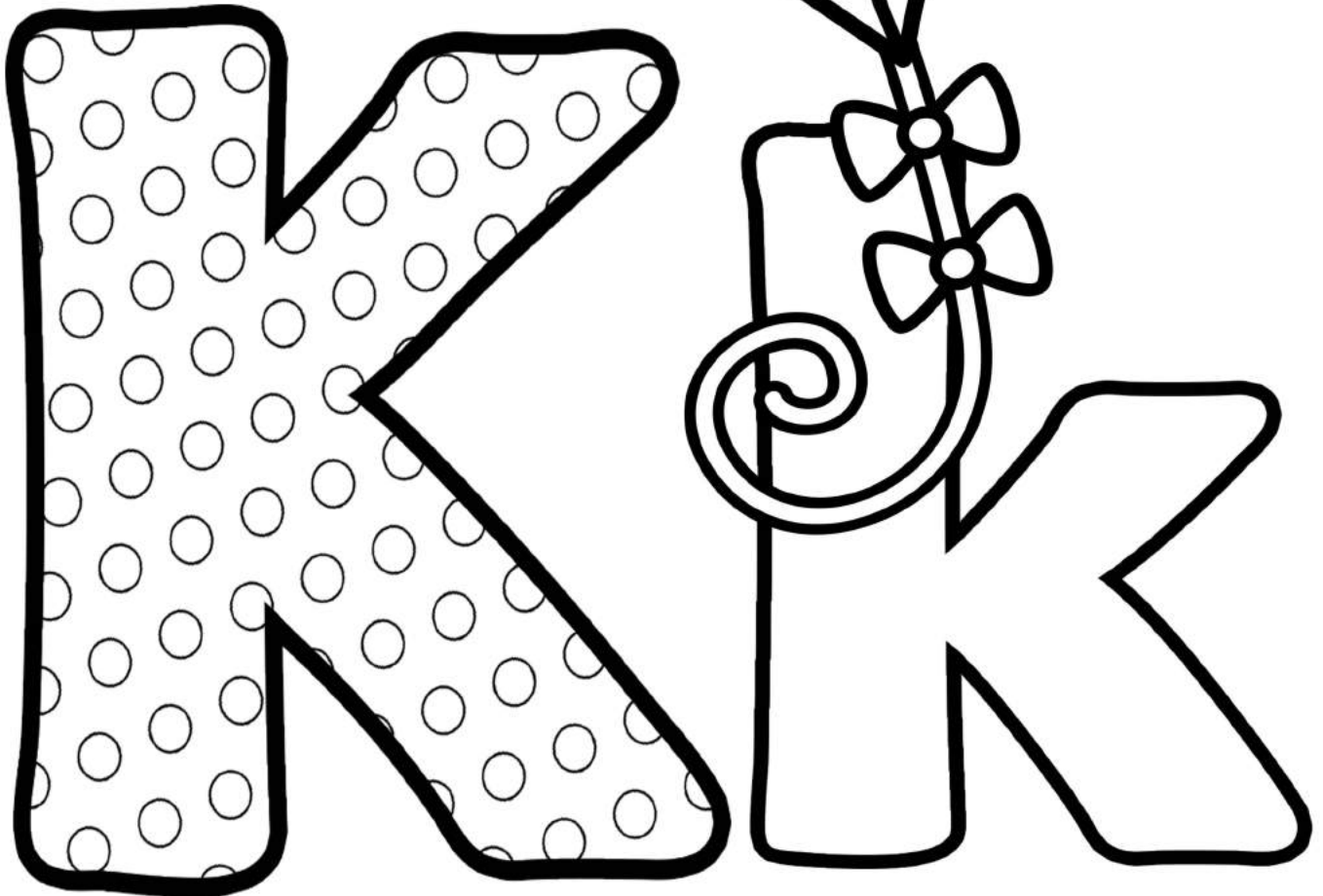
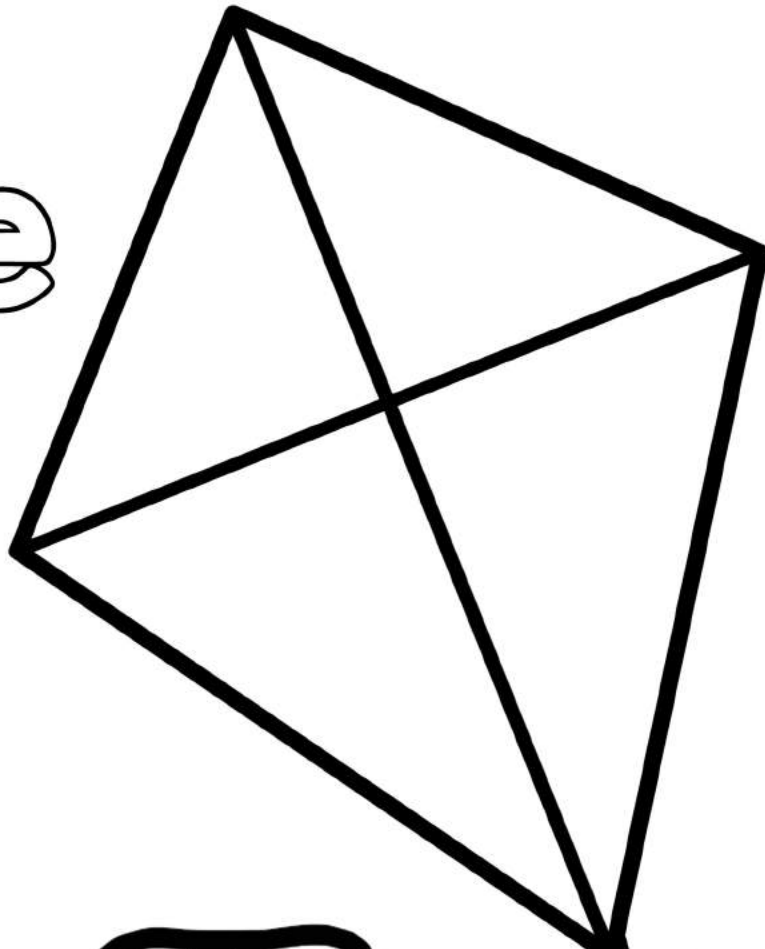

Kk

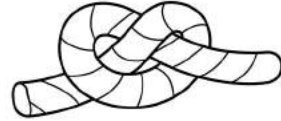
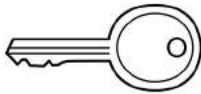
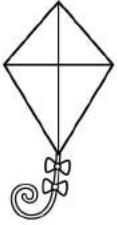
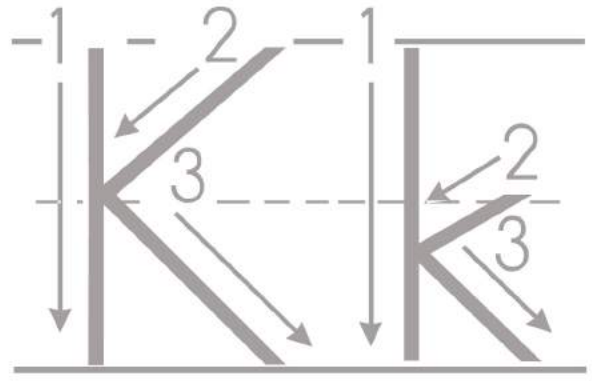

kite

king

key

kitten

knot

knight

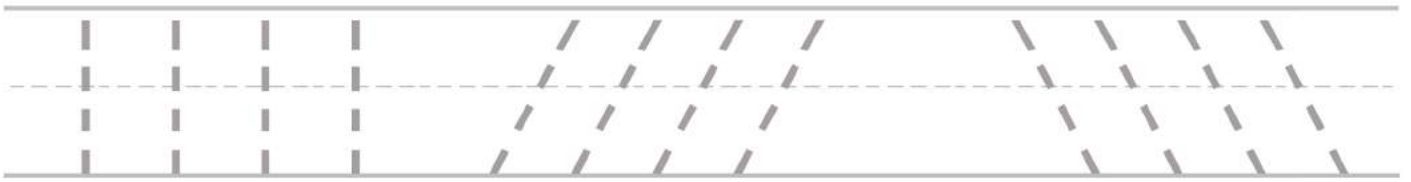

Match the keys by size

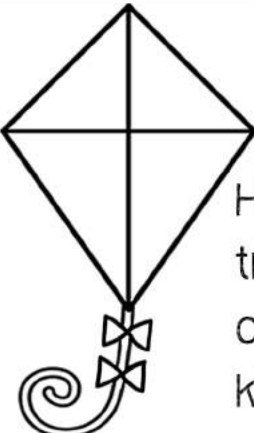

How many triangles on the kite?

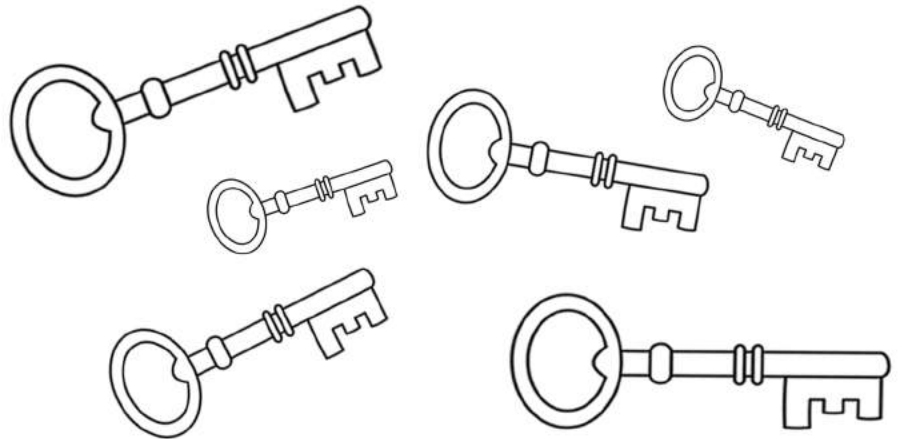
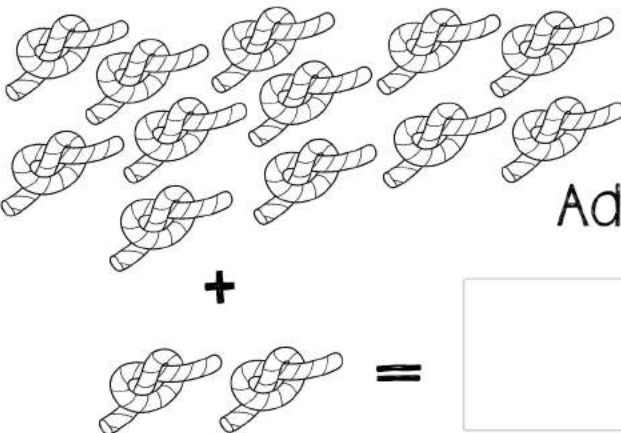
Add

$+$

$=$

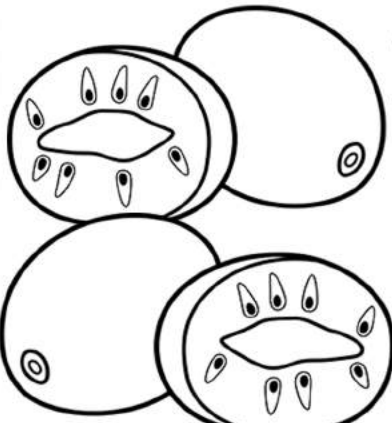

Count & Tally the kiwi seeds

$12 + 1 =$

$12 + 2 =$

12	1
+ 1	+ 12
<input type="text"/>	<input type="text"/>

Draw a mat under the cat.

Draw a bowl of milk in front of the cat.



Cross out every other knight.

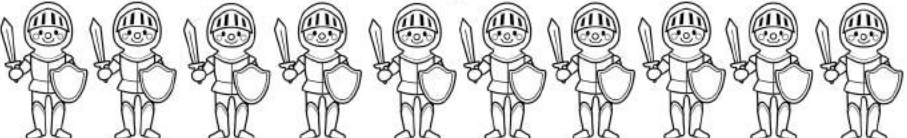

Draw: $12 + 2 = 14$

$+$ $=$

Kk

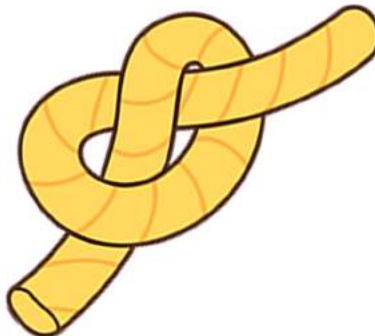
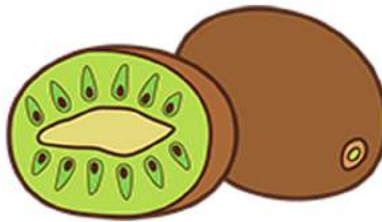
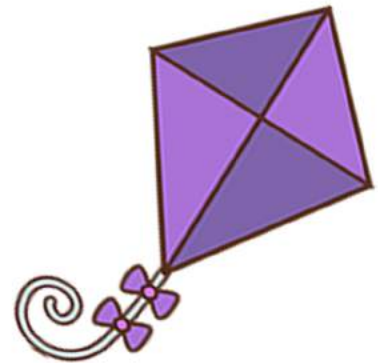
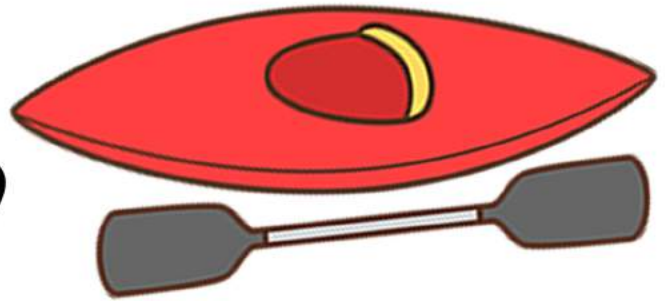

I CAN COLOR

words with:

-  = kite
-  = kitten
-  = key
-  = kiwi
-  = king
-  = kayak
-  = knight
-  = knot

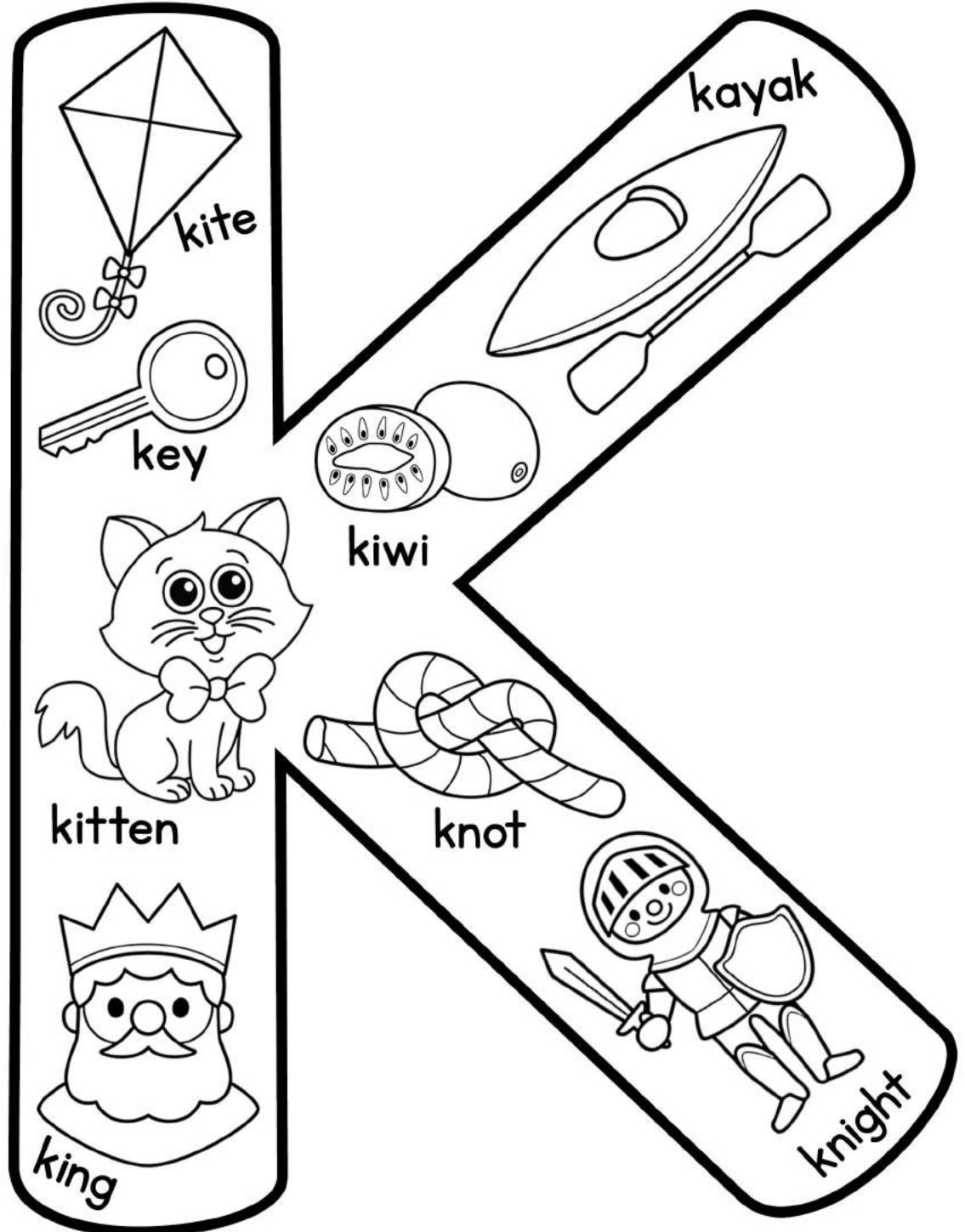

NAME : _____

Kk

Write and read words that begin with letter k.



key key key

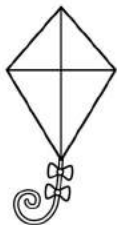

kite kite kite

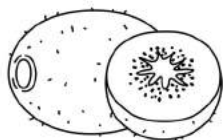

kiwi kiwi kiwi



king king king



knot knot



kettle kettle



kayak kayak

NAME : _____

Kk

Write and read words that begin with letter k.



key key key

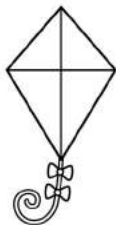

kite kite kite

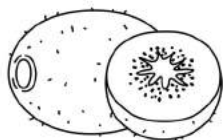

kiwi kiwi kiwi



king king



knot knot



kettle kettle

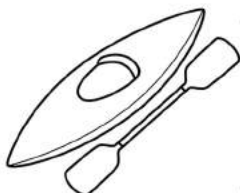

kayak kayak

NAME : _____

RACE TO THE TOP

Use a paperclip and a pencil to complete the spinner.

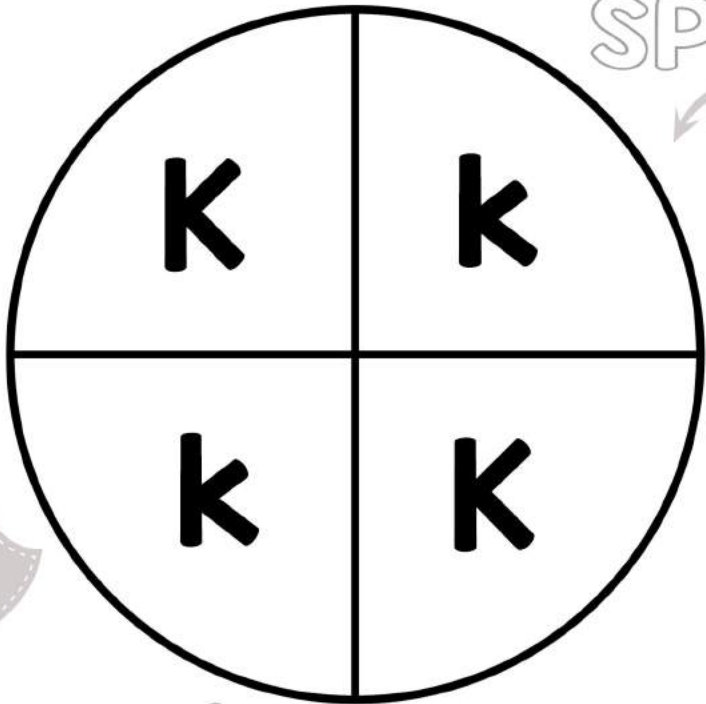

SPIN



Record

Report:

How many spins landed on K?

How many spins landed on k?

Which had more?

Write an inequality: >

How many spins total?

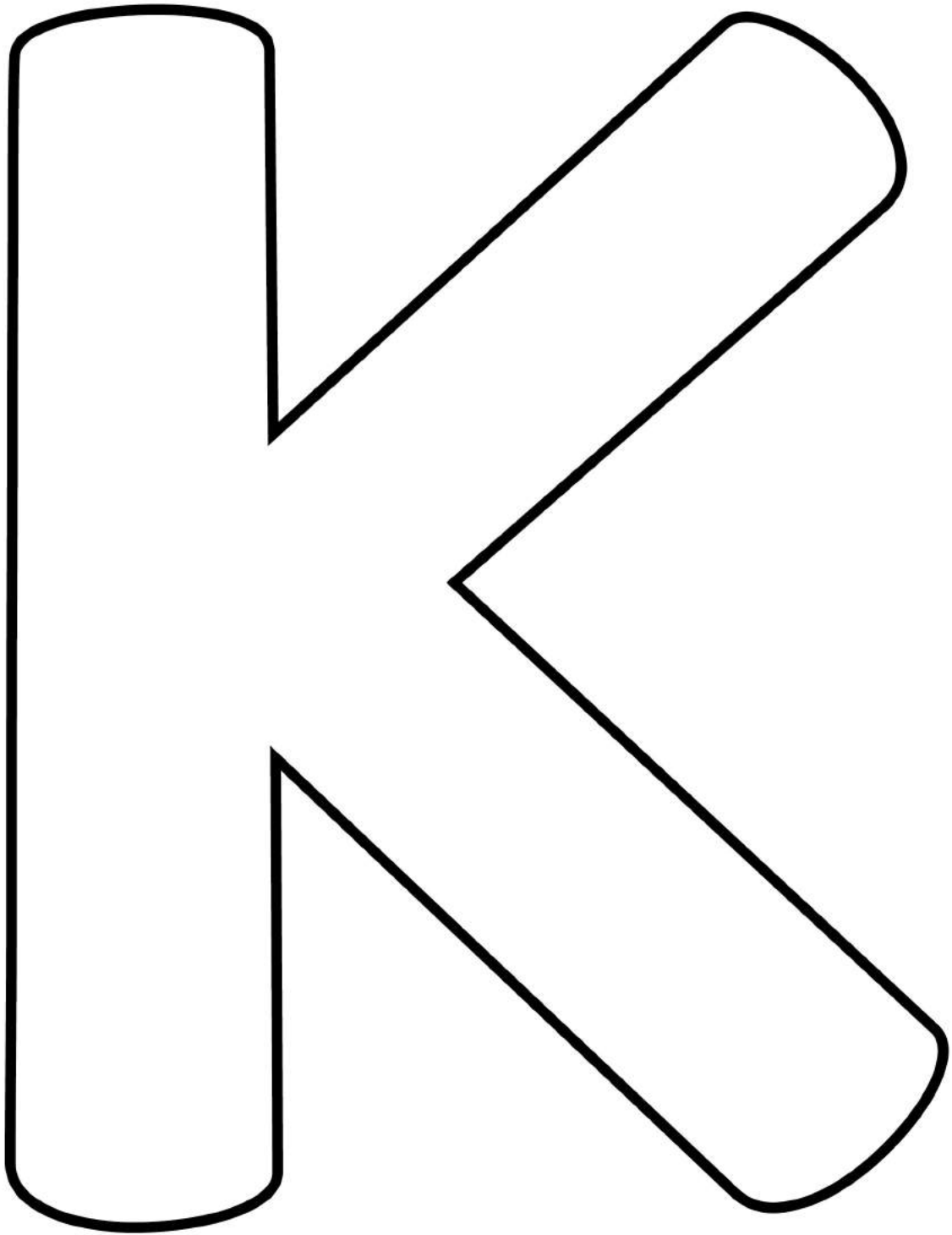

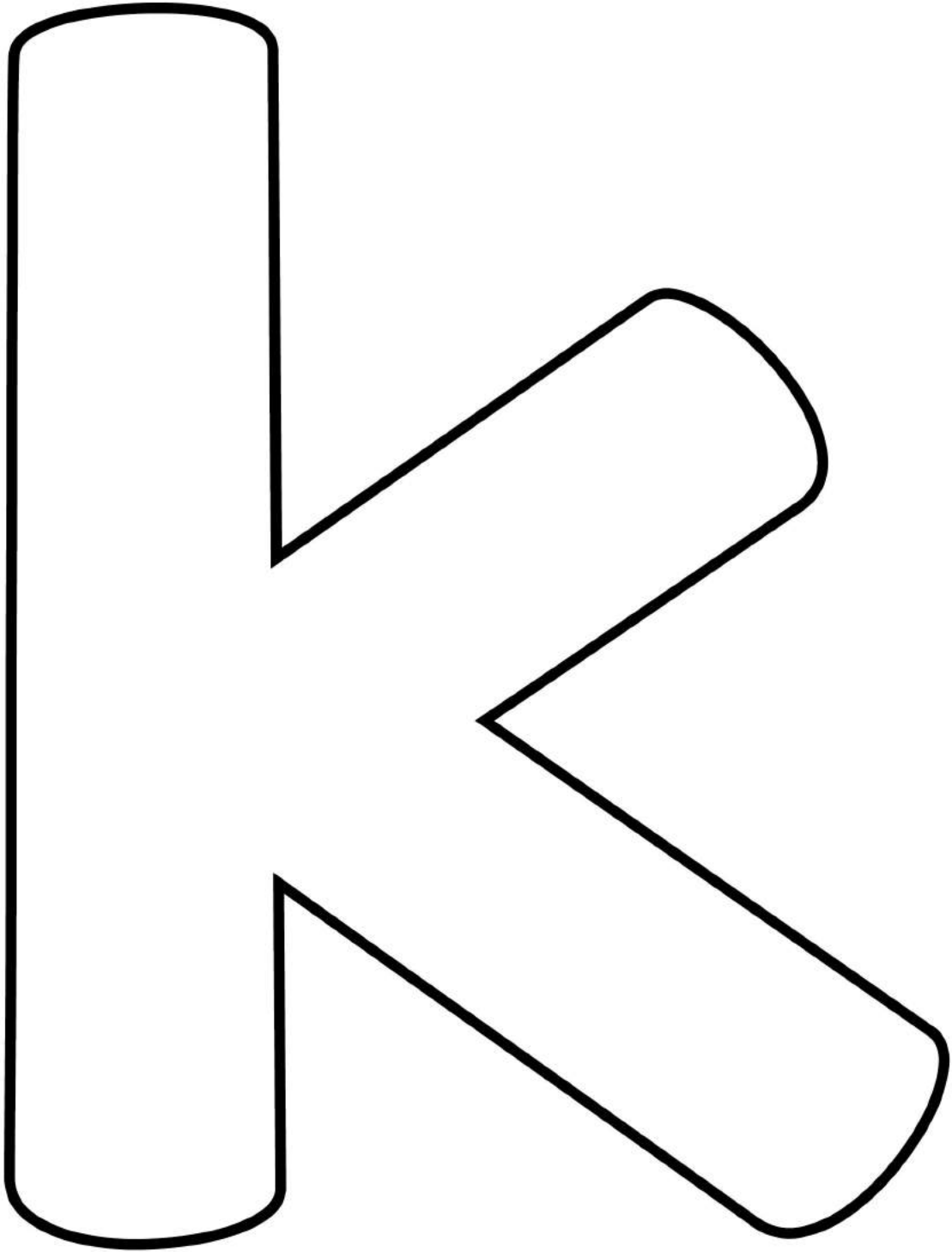

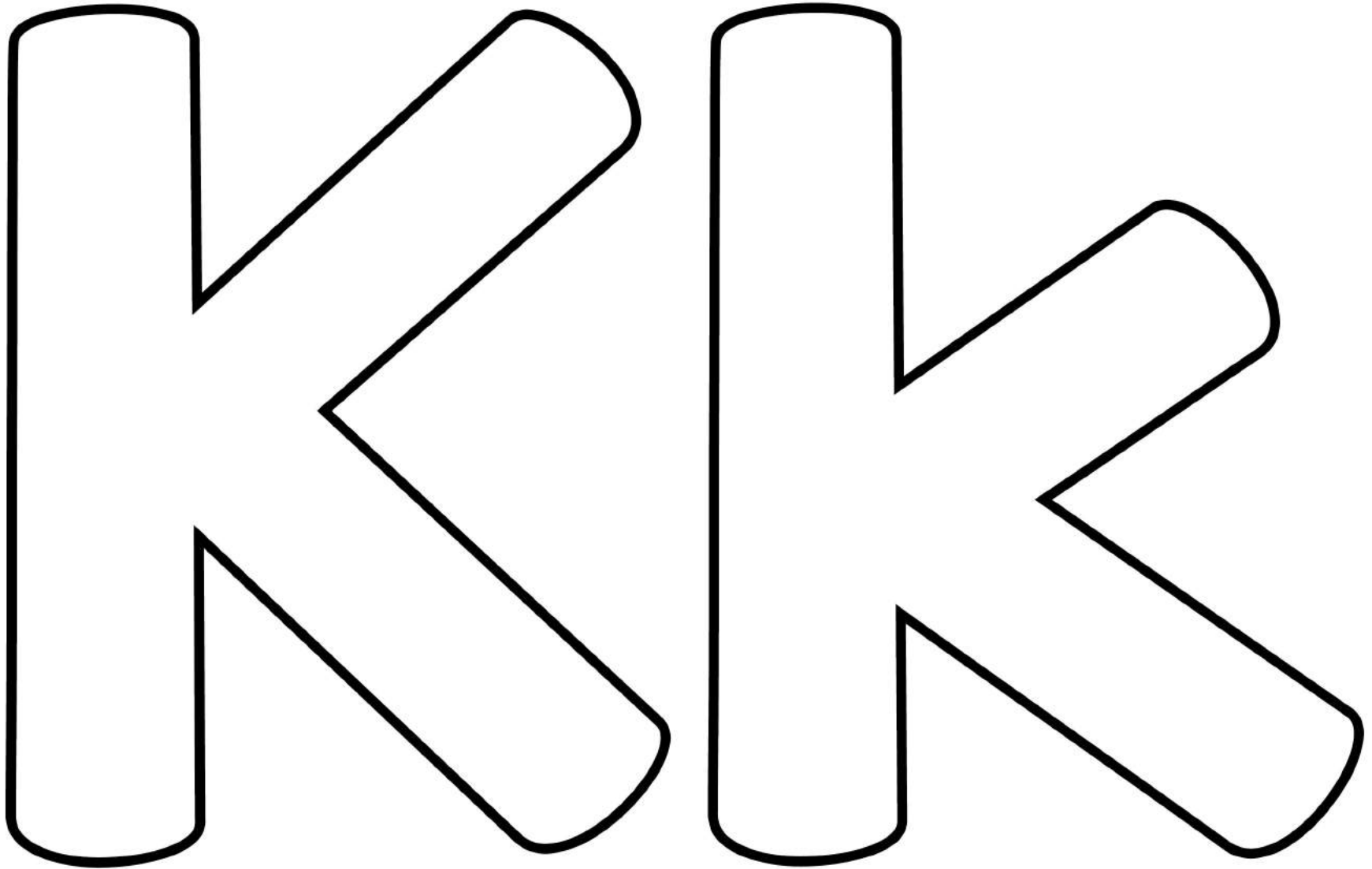

★ I ★

★ C ★ ★ A ★ ★ N ★

★ F ★ ★ I ★ ★ N ★ ★ D ★

the letter:

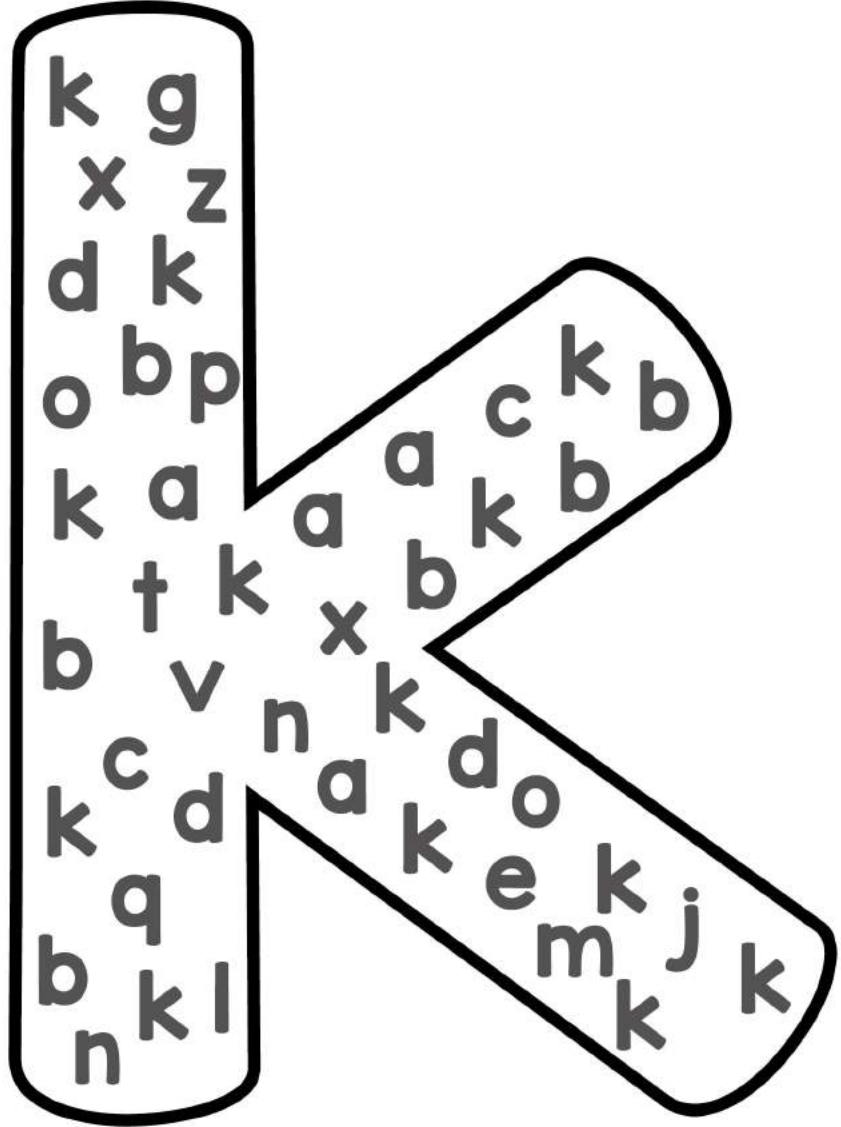
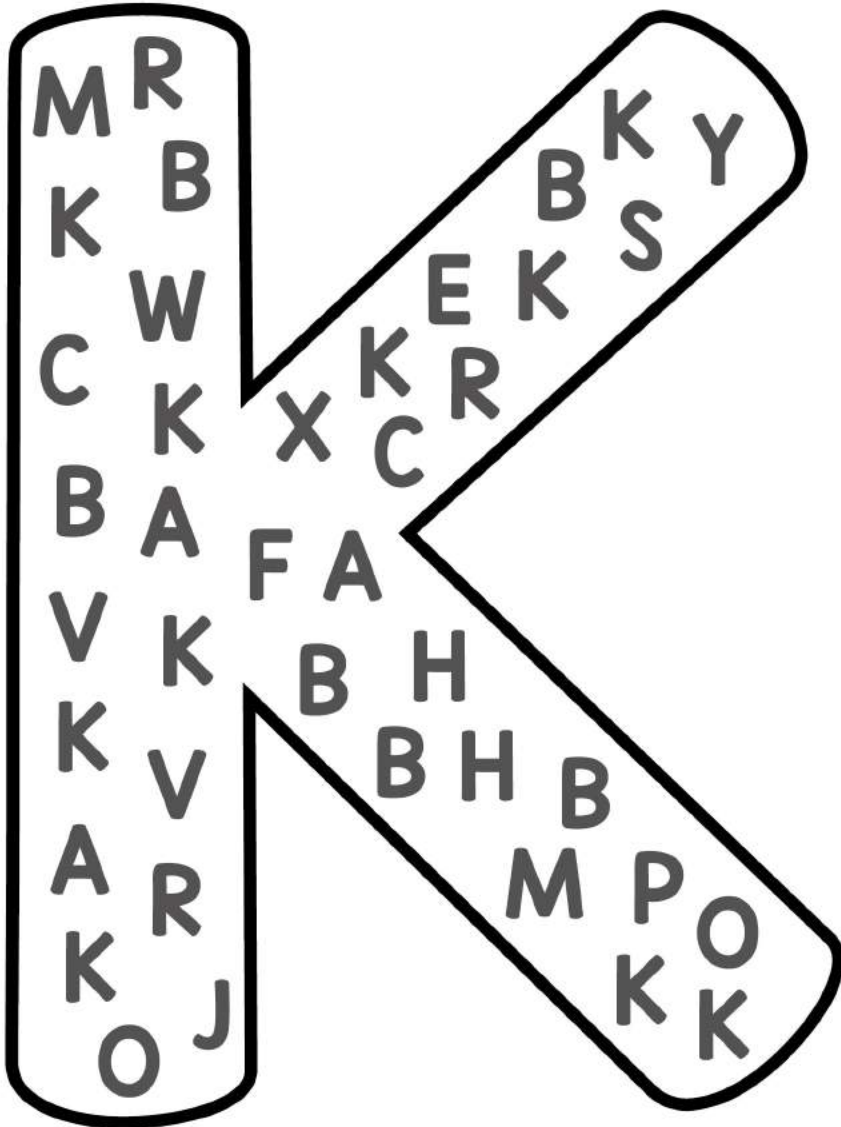

How Many?

How Many?

TRACE

NAME : _____



Color one for each row of letters you complete

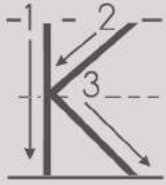

K K K K K K

K K K K K K

K K K K K K

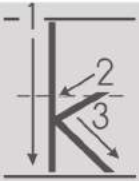

k k k k k k k

k k k k k k k





k k k k k k k

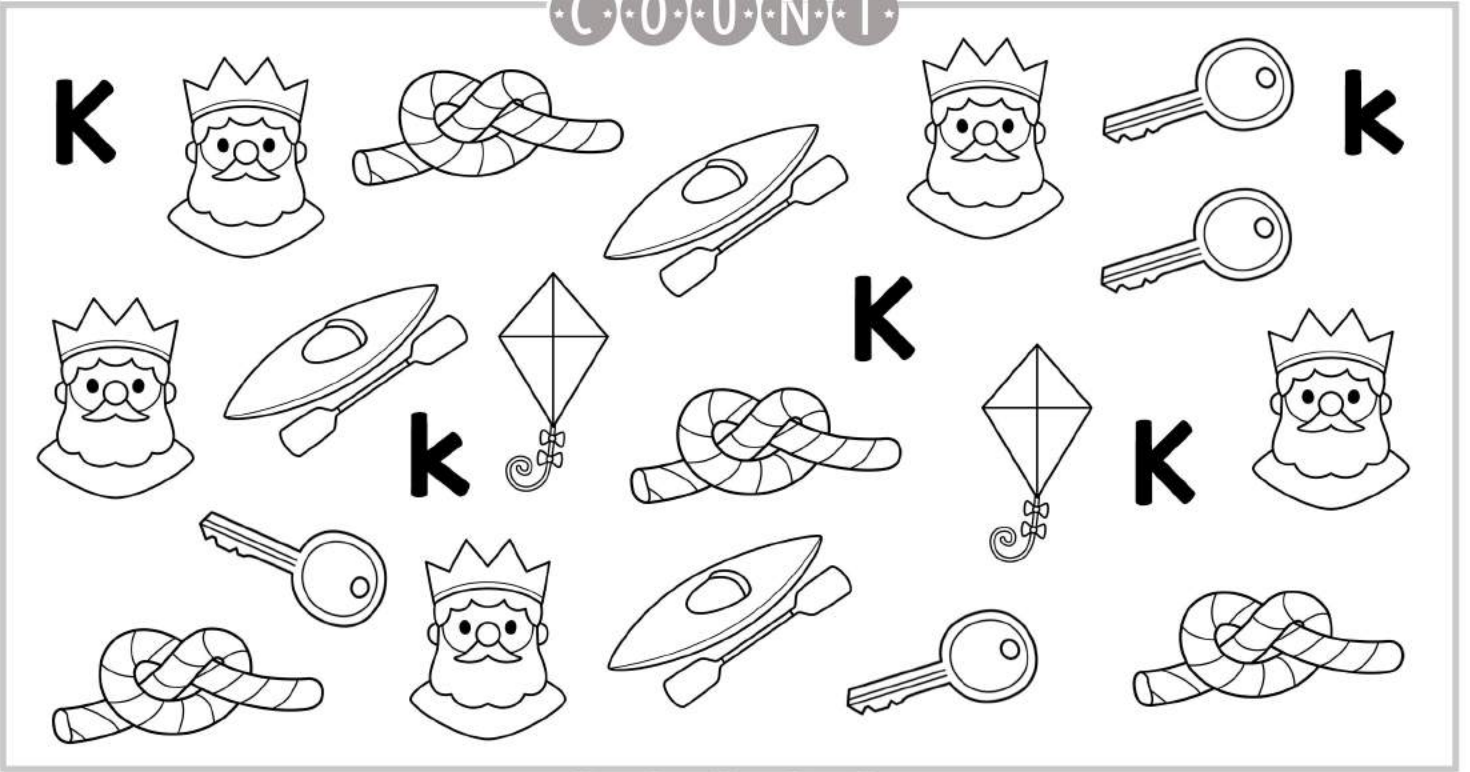

C · O · U · N · T



G · R · A · P · H

K	k					

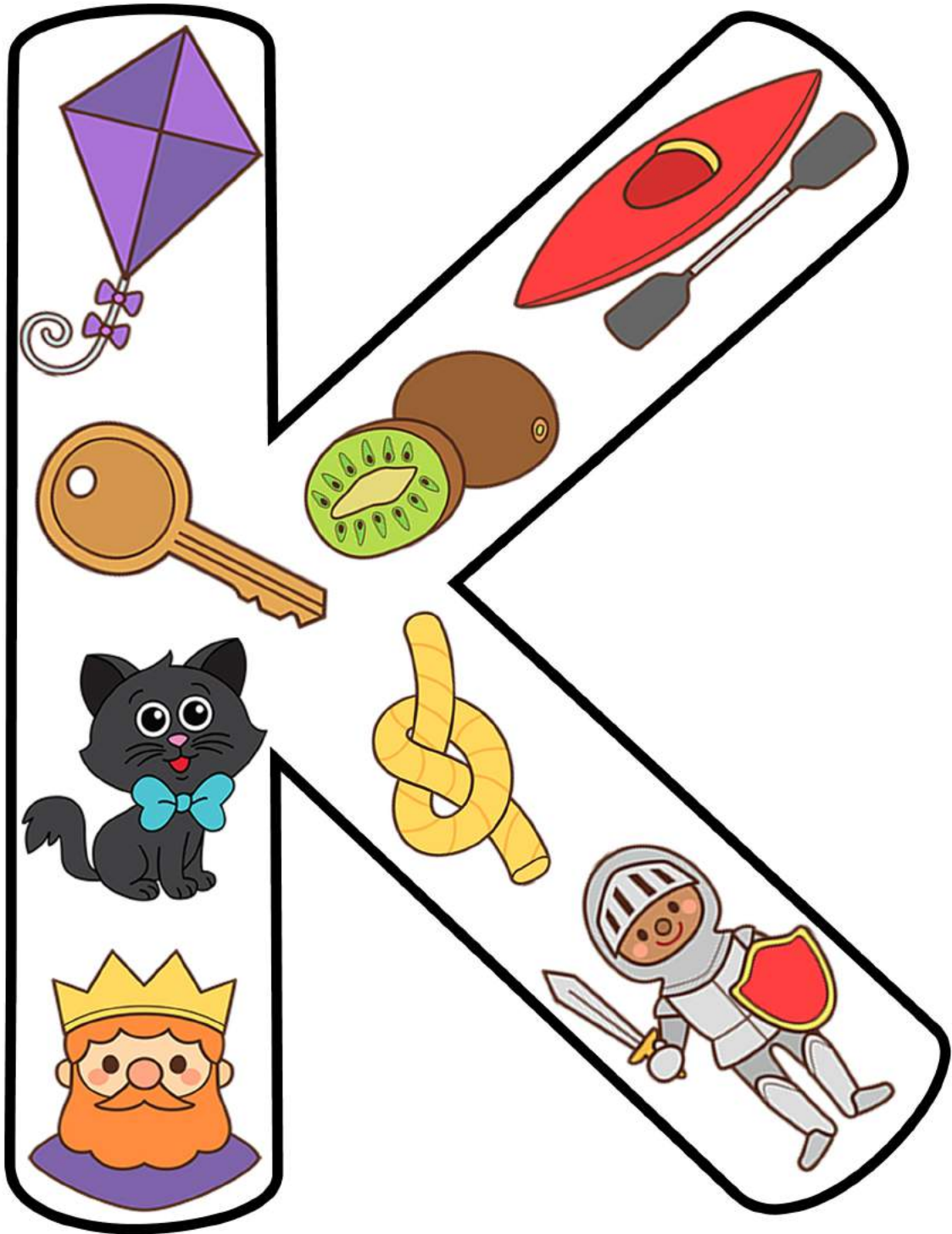

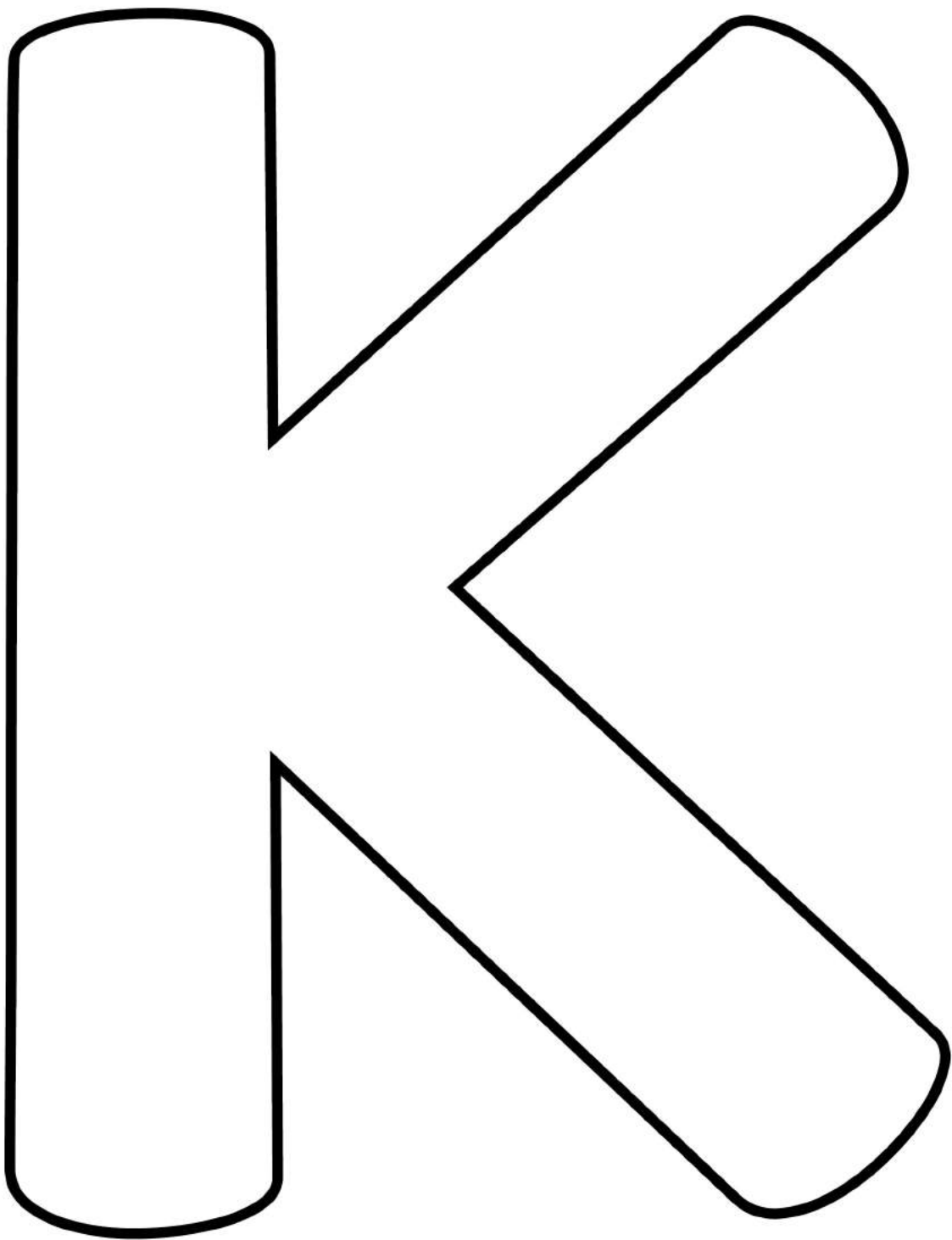

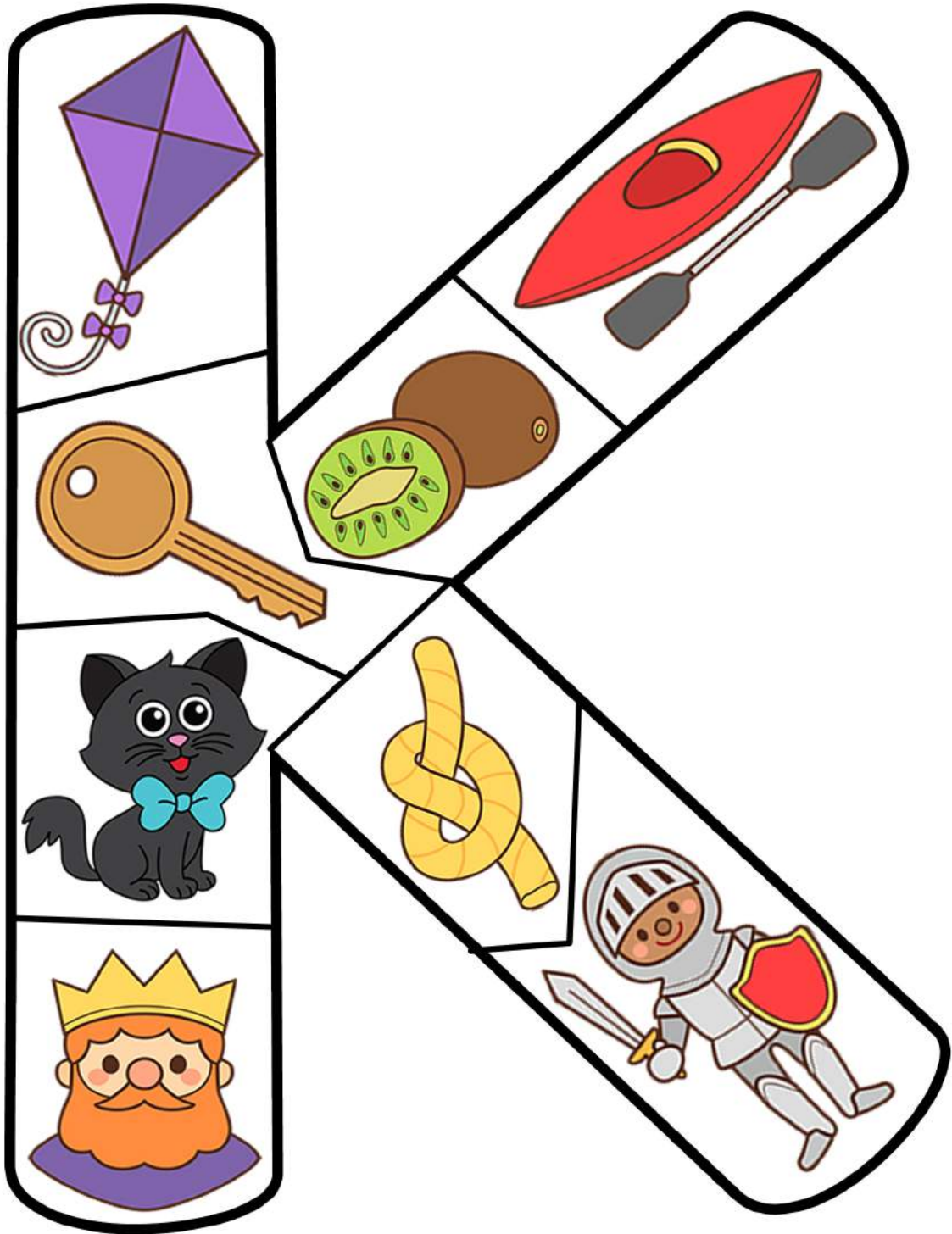

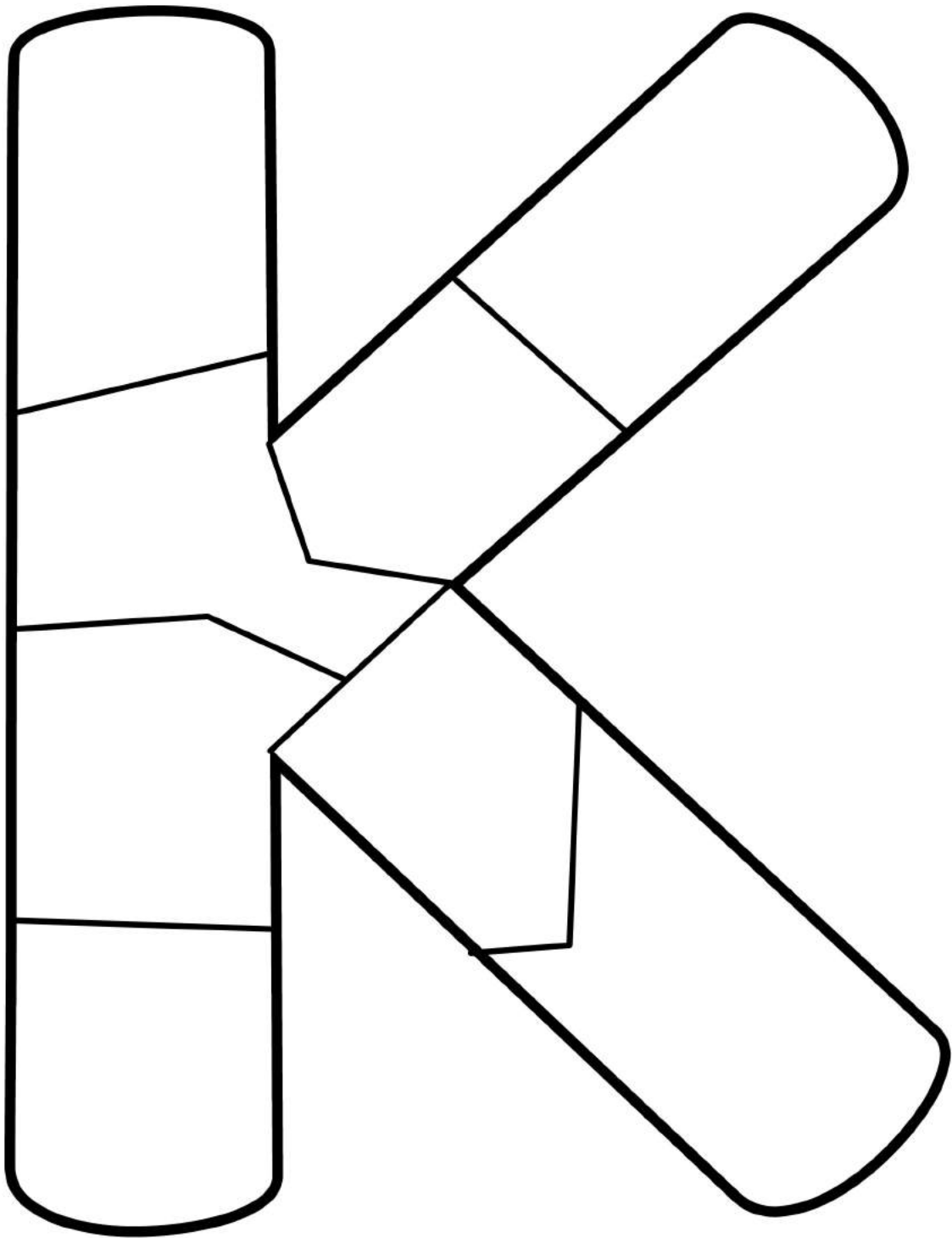

1. Write

2. Cut Out 

NAME : _____



A B C Q U I L T

3. Color

4. Cut out 

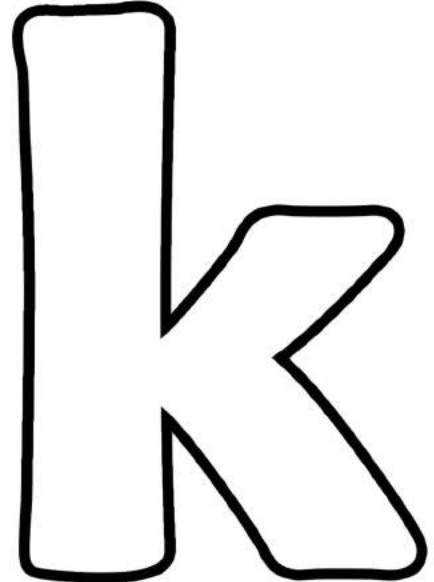
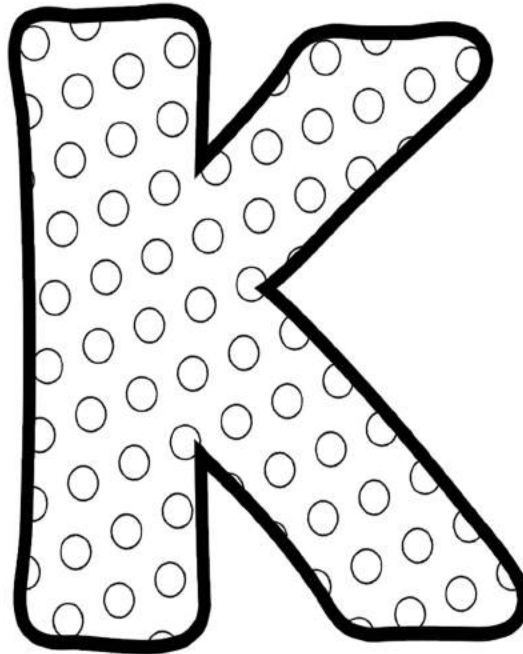
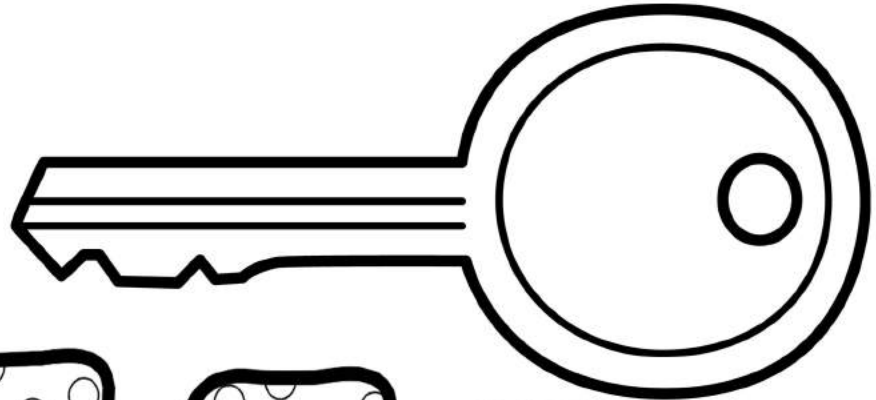

NAME : _____

NAME : _____

Kk

Write and read words that begin with letter k.



key key key

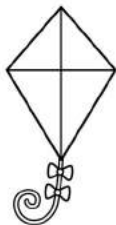

kite kite kite

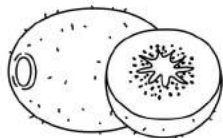

kiwi kiwi kiwi



king king king



knit knit



kettle kettle



kayak kayak



kitten



king



kayak



kite

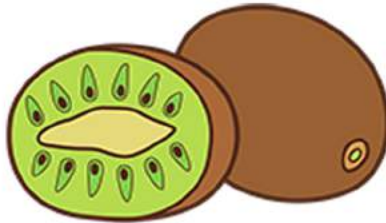

kiwi



knight



key

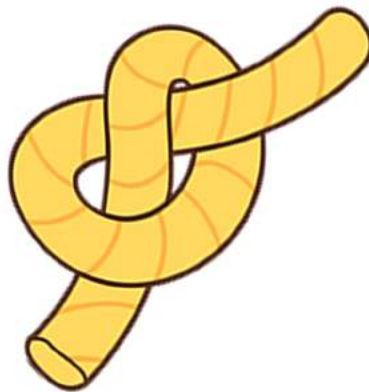

knot



kettle

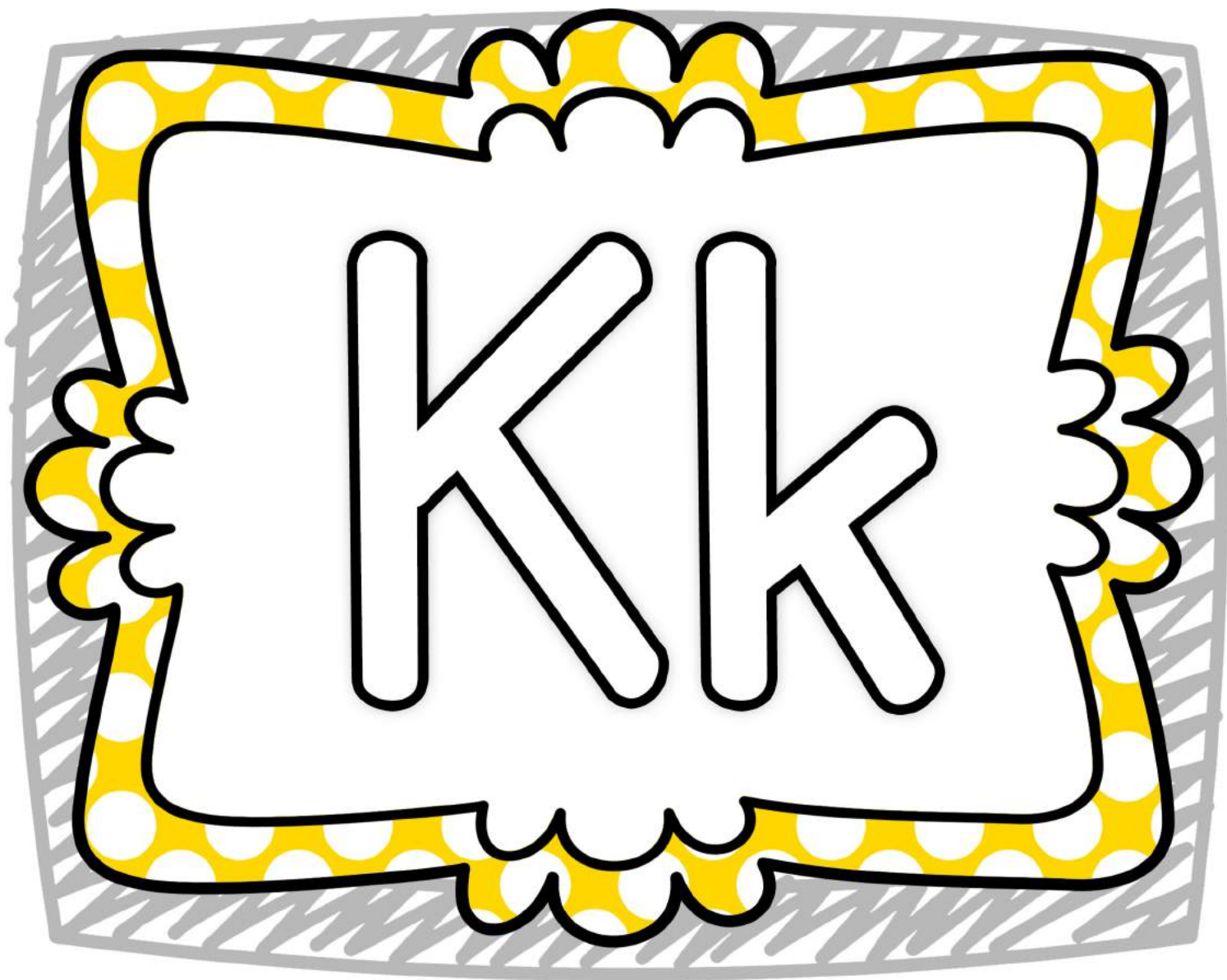

LETTER K



4 IN A ROW

K			
			k

LETTER K



4 IN A ROW

			K
k			

LETTER K



4 IN A ROW

LETTER K



4 IN A ROW

I C A N W R I T E

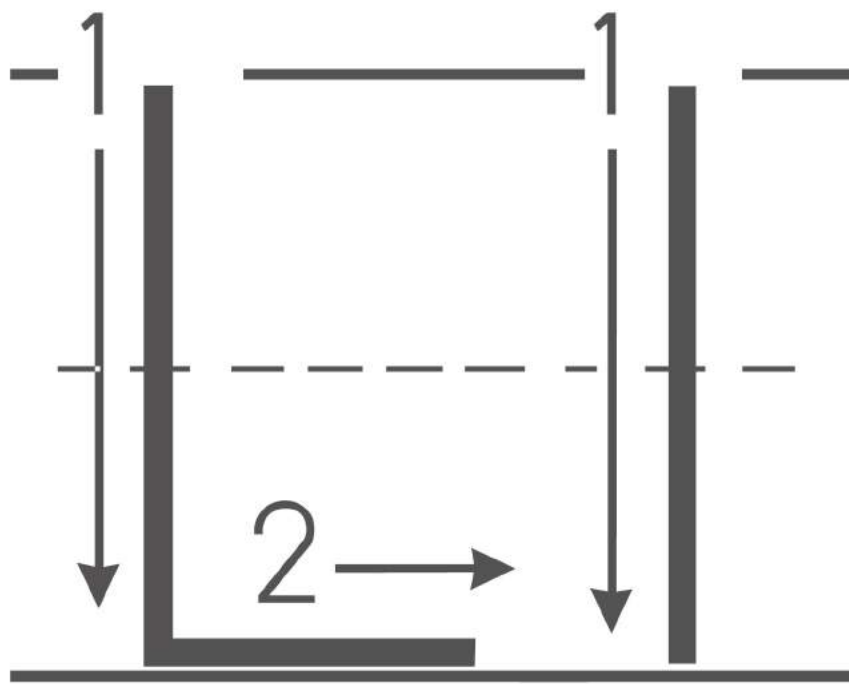

Line Down

Line Down

Pick up

Slide Over

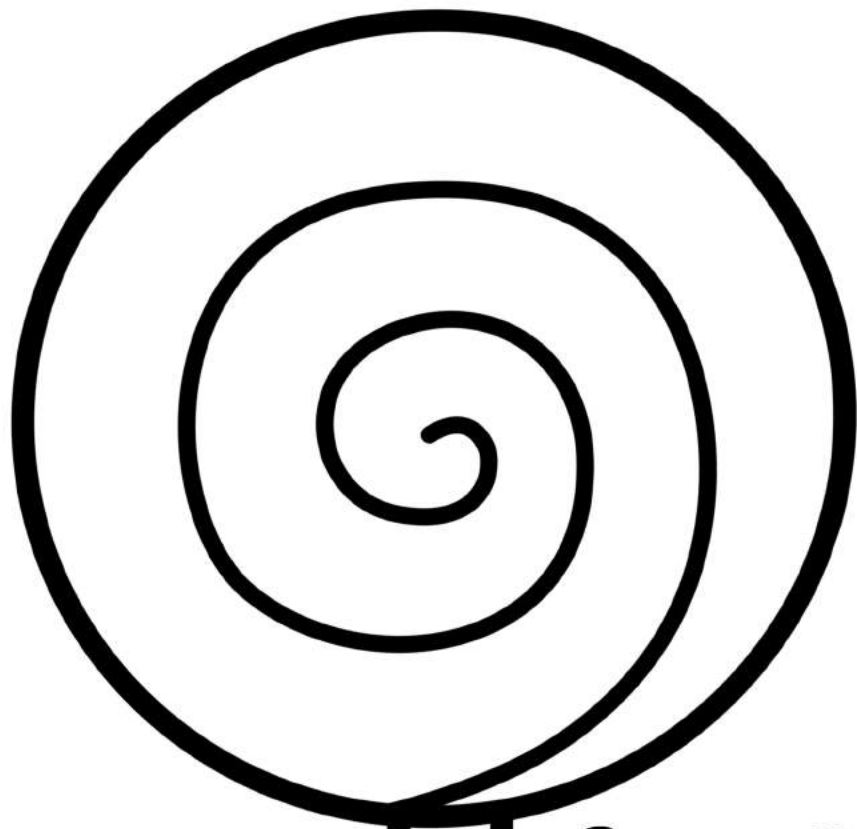

Lollipop

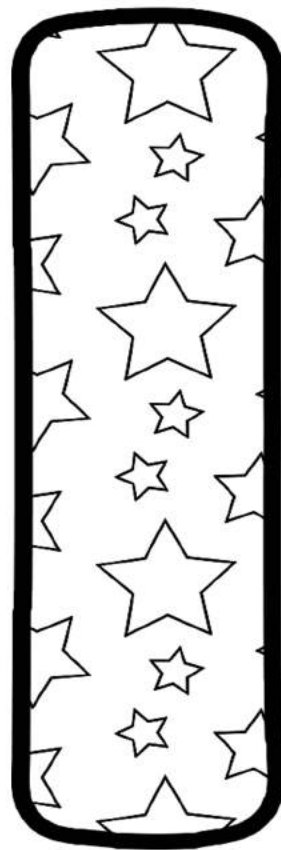
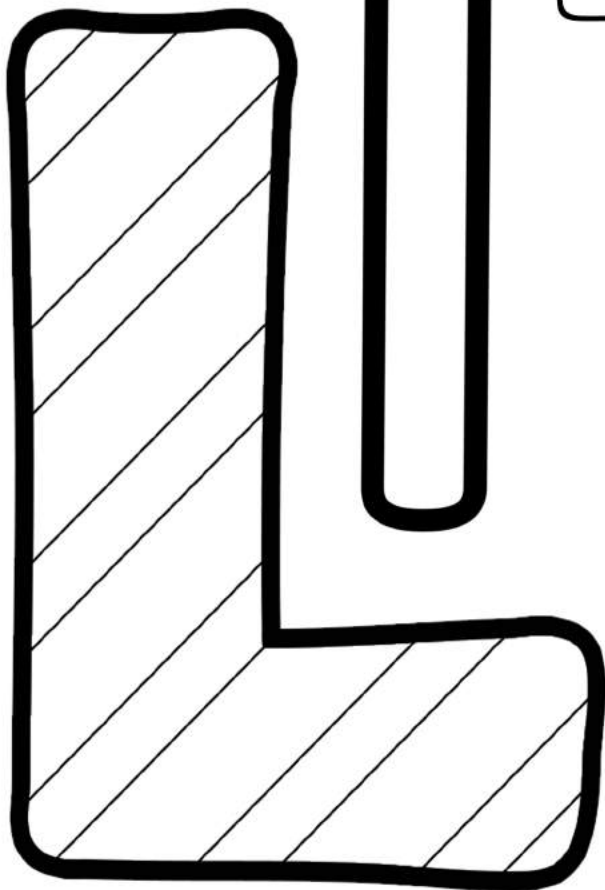

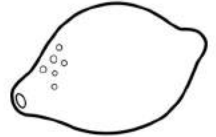
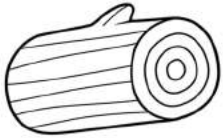
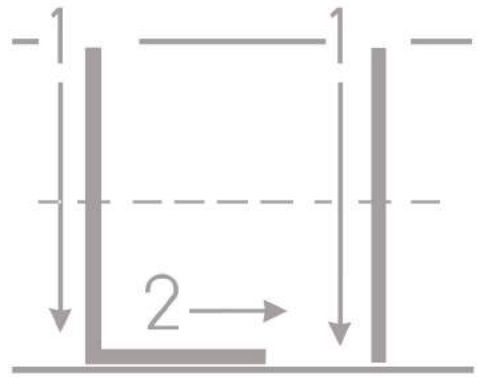
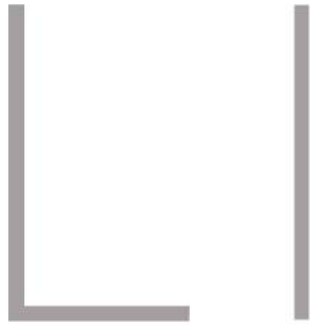

log

lamp

lion

lock

lollipop

lemon

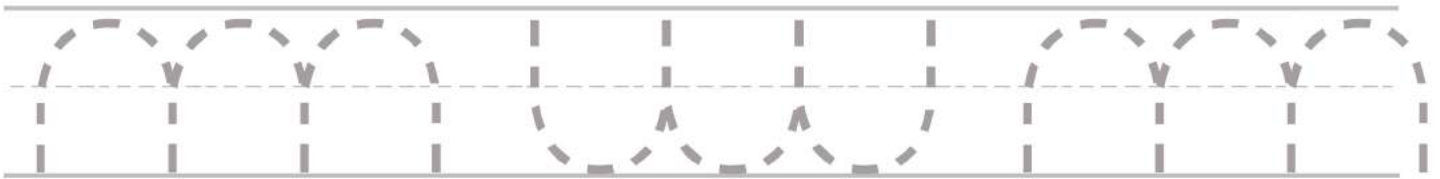

Match each leaf to its shadow

Trace the spiral in the lollipop

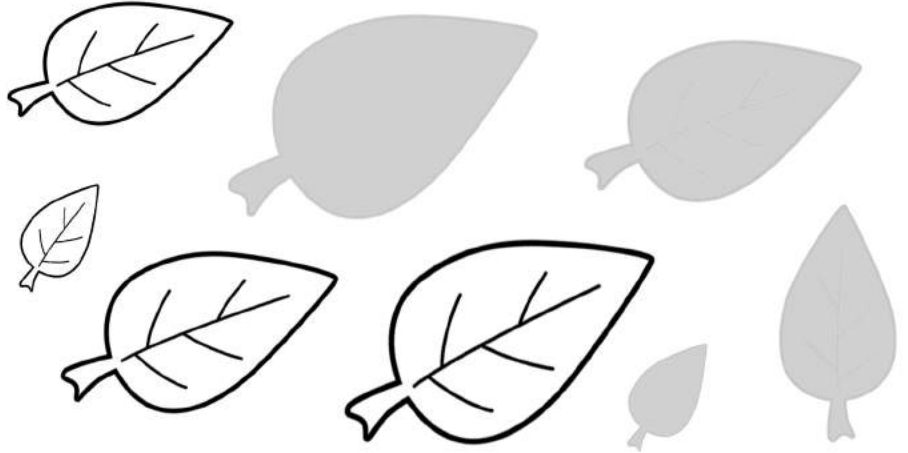
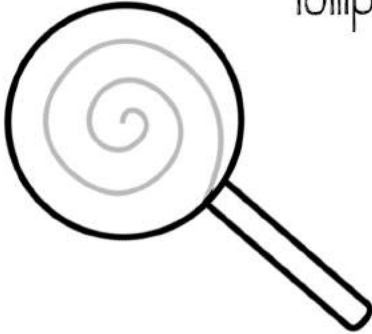

Add

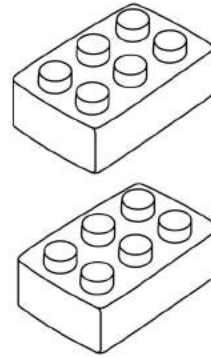
$$13 + 1 = \square$$

Count & Tally the pegs.

$$13 + 1 = \square$$

$$13 + 2 = \square$$

$$\begin{array}{r} 13 \\ + 1 \\ \hline \square \end{array} \quad \begin{array}{r} 12 \\ + 2 \\ \hline \square \end{array}$$

Draw a hat on the lion.
 Draw a lollipop in his paw.
 Draw a log under his paw.
 Draw an "L" behind the lion.

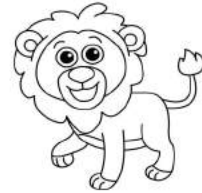

Color the 2nd, 3rd, 4th, 7th, 9th and 11th lollipop.



Draw: $13 + 1 = 14$

$$+ =$$

L l

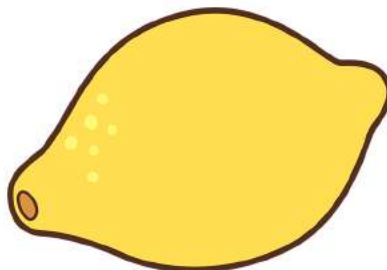
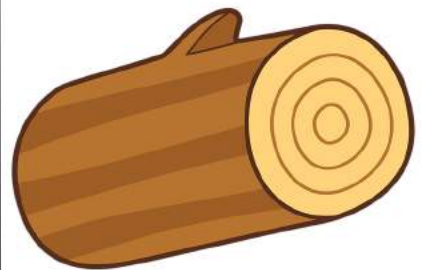
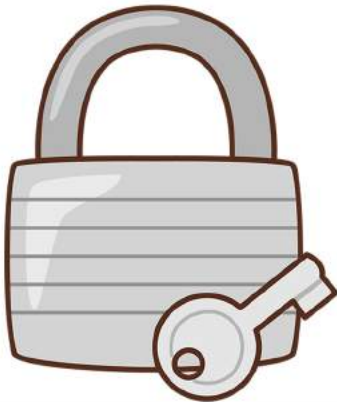



I CAN COLOR

 = lollipop

 = lion

 = ladder

 = lego

 = log

words with:

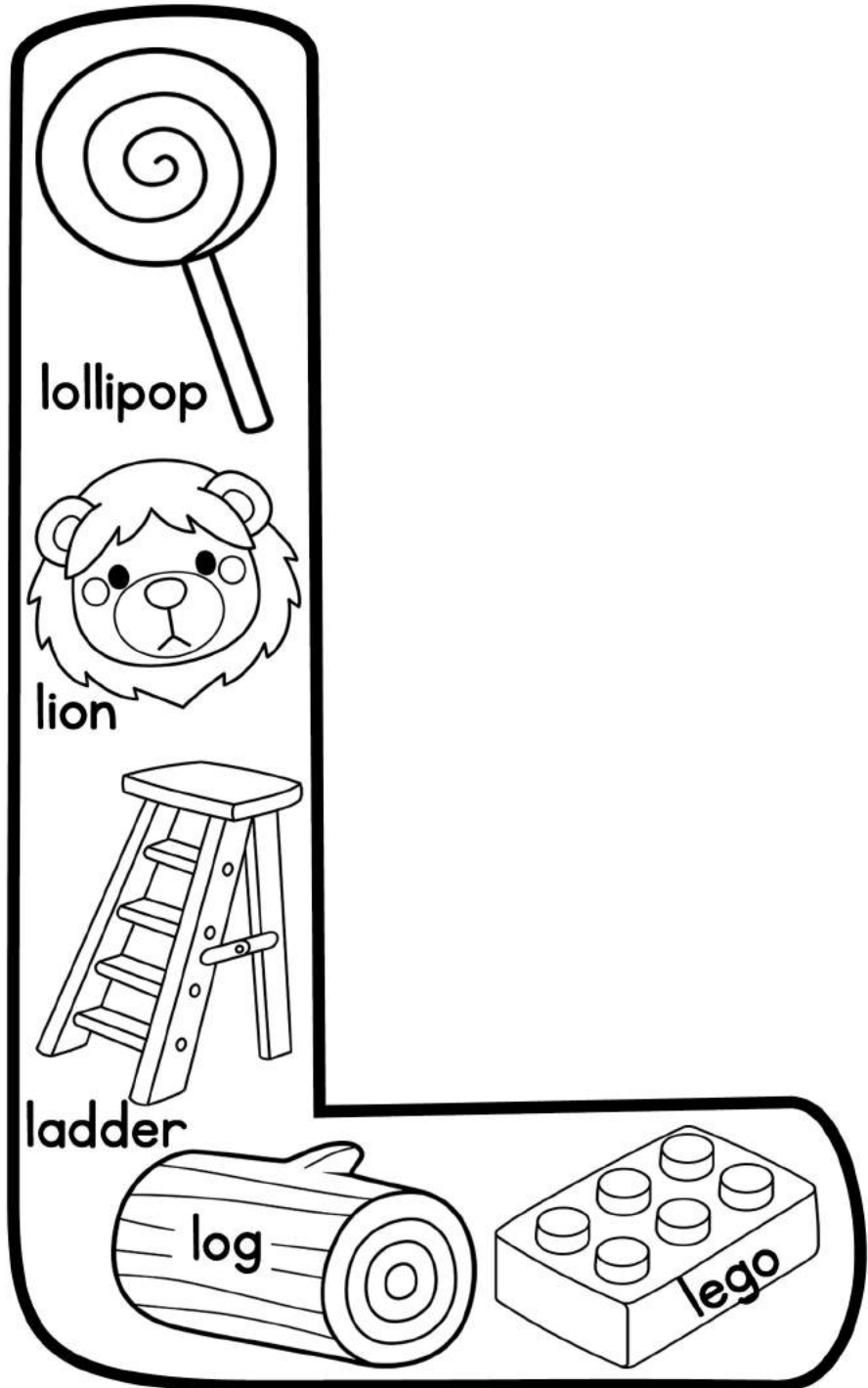

NAME : _____

LI

Write and read words that begin with letter l.



log log log



lock lock lock



leaf leaf



lion lion lion

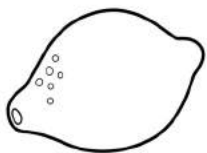

lemon lemon



lamp lamp



lollipop lollipop

NAME : _____

LI

Write and read words that begin with letter l.



log | log | log



lock | lock



leaf | leaf



lion | lion

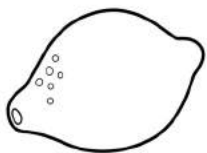

lemon | lemon



lamp | lamp



lollipop

NAME : _____

RACE TO THE TOP

Use a paperclip and a pencil to complete the spinner.

L	I
L	I
L	I
L	I
L	I
L	I
L	I
L	I
L	I
L	I

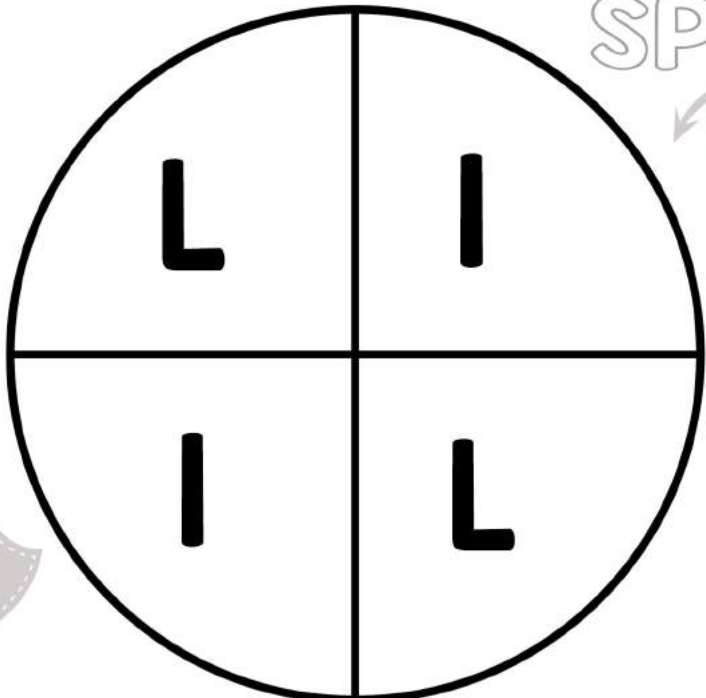

SPIN

Record

Report:

How many spins landed on L?

How many spins landed on I?

Which had more?

Write an inequality: >

How many spins total?

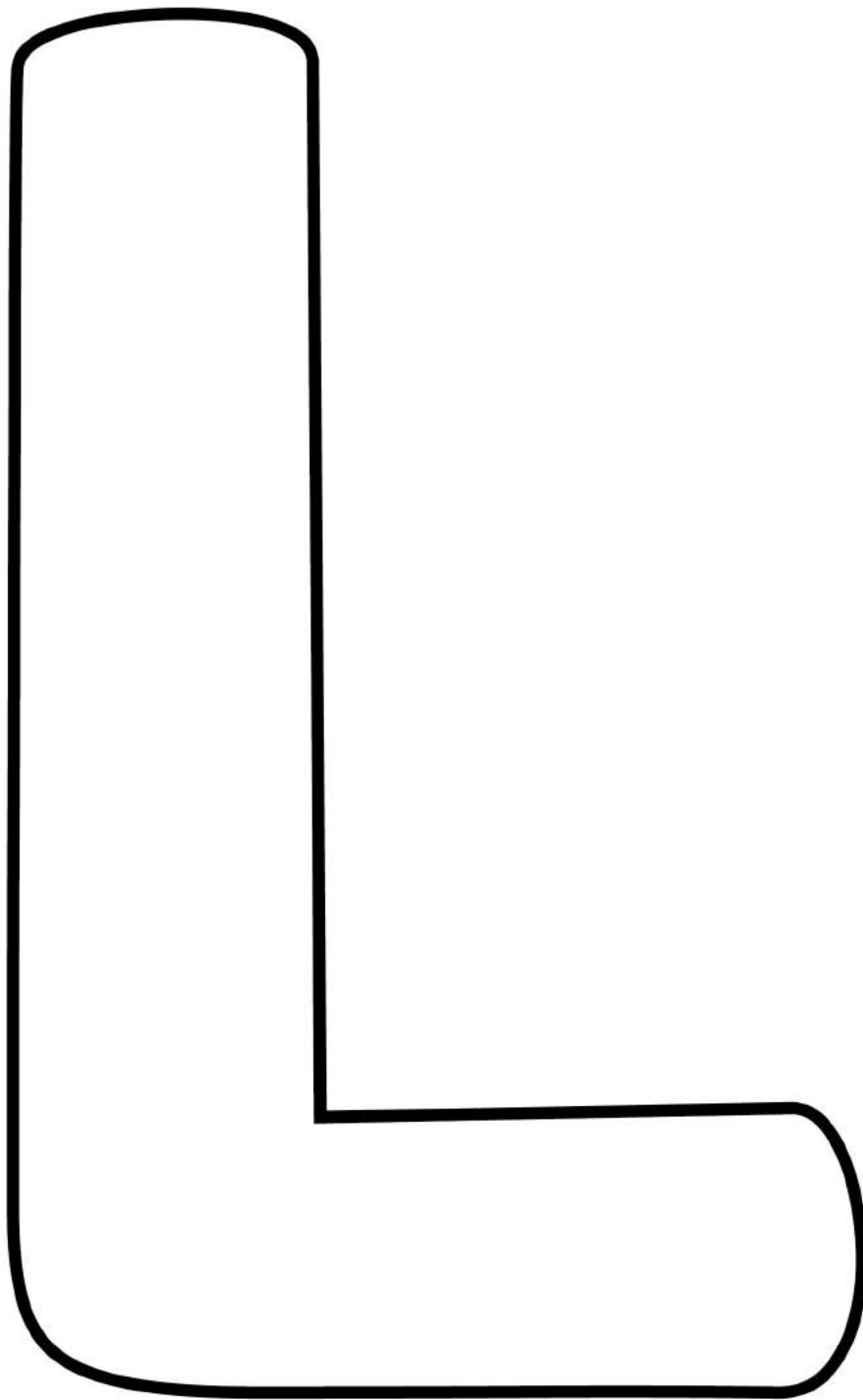

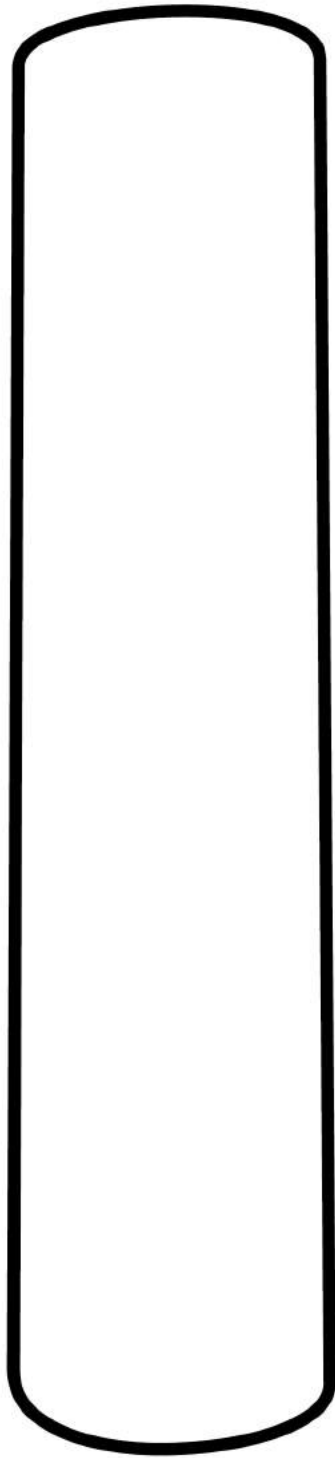

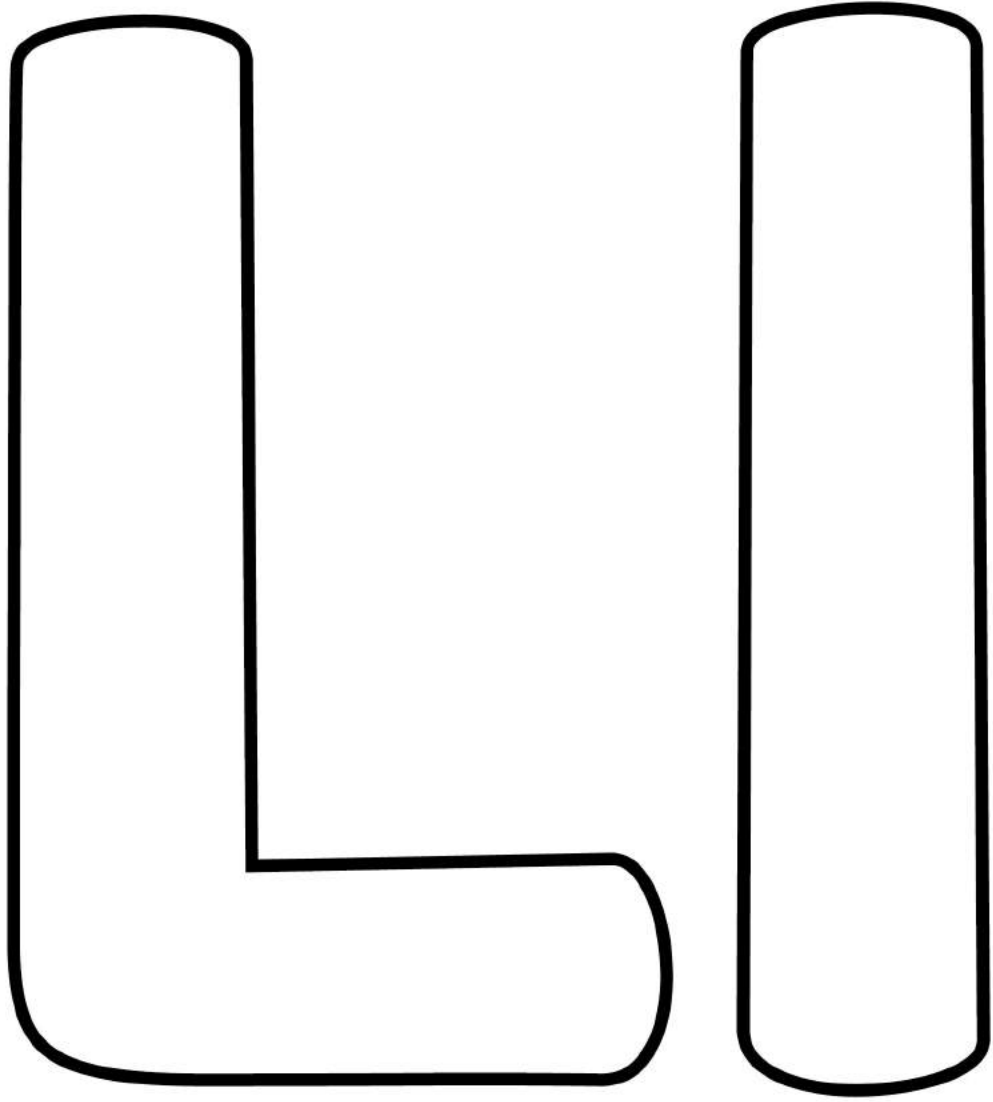

I C A N F I N D

the letter:

L B S
 K L
 Y K
 L R B
 A K
 F
 H L
 B H
 L M
 P K O L O K L
 L K J R L V

g k l
 x k
 z b
 o i p
 k a a
 k t x i
 v i k
 d b n
 i q n i
 b k

How Many?

How Many?

TRACE

NAME : _____





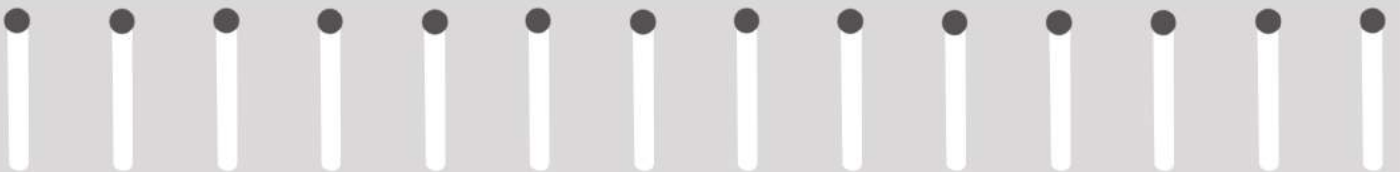
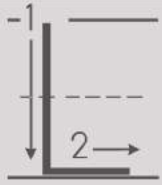

Color one for each row of letters you complete

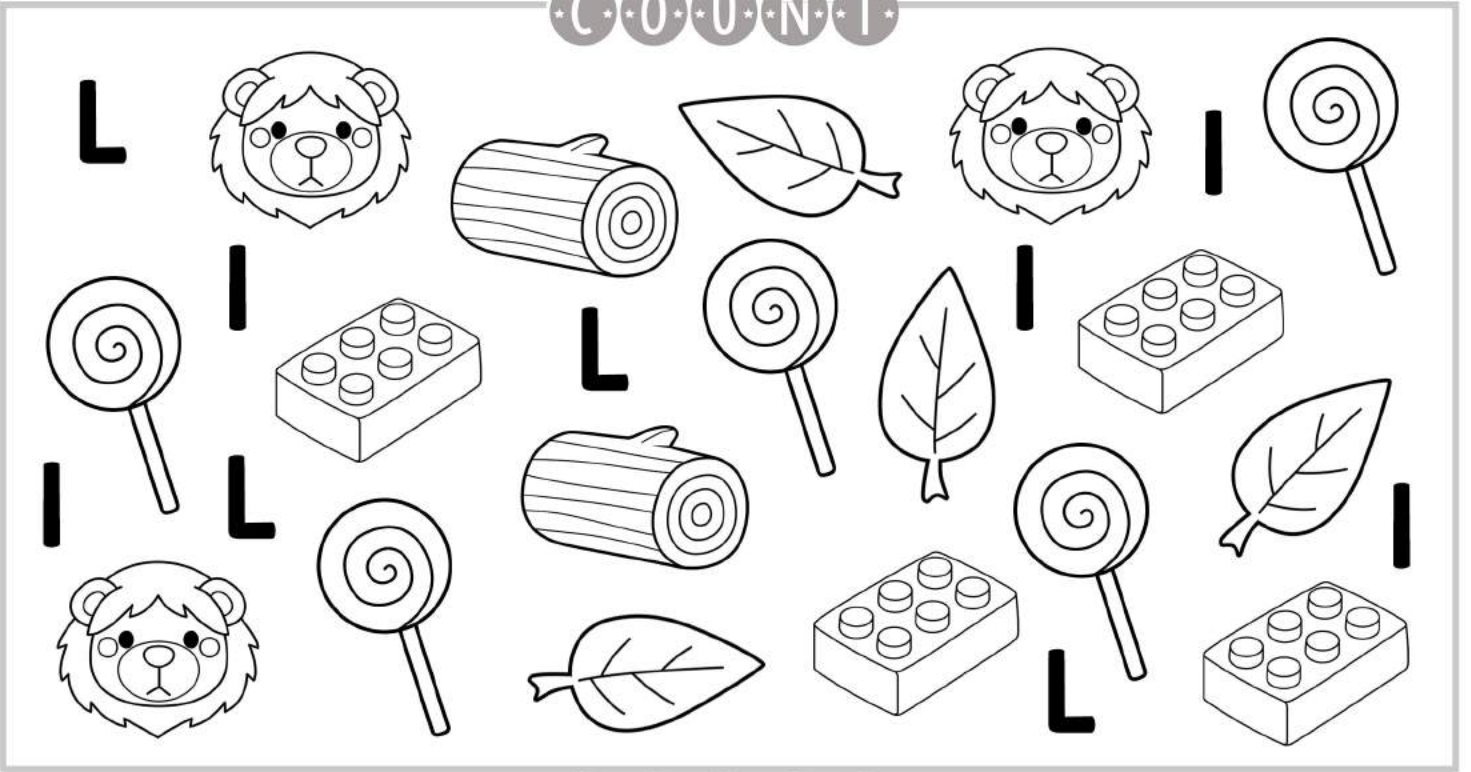

C · O · U · N · T

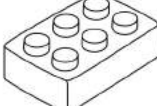

G · R · A · P · H

L	I					

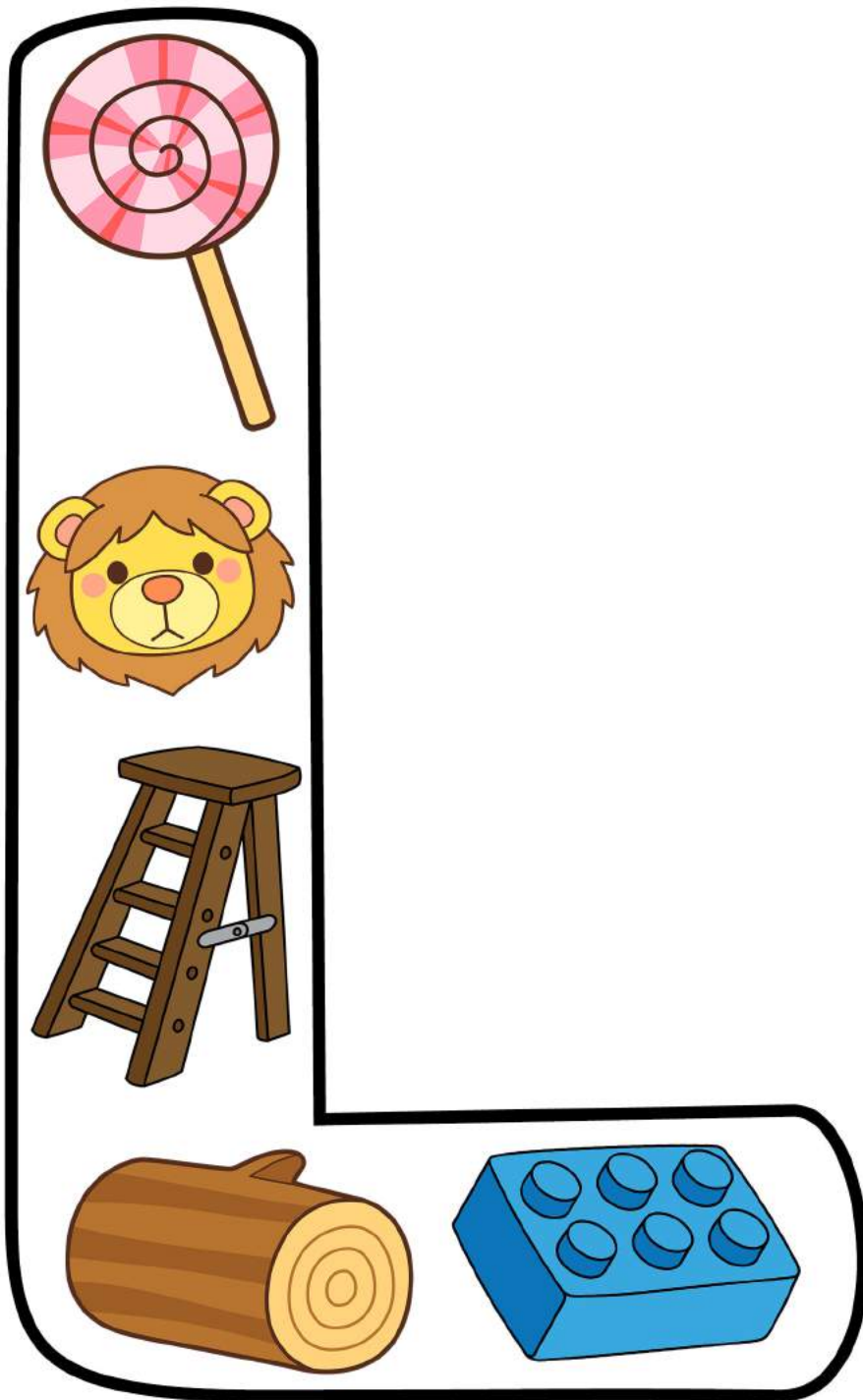

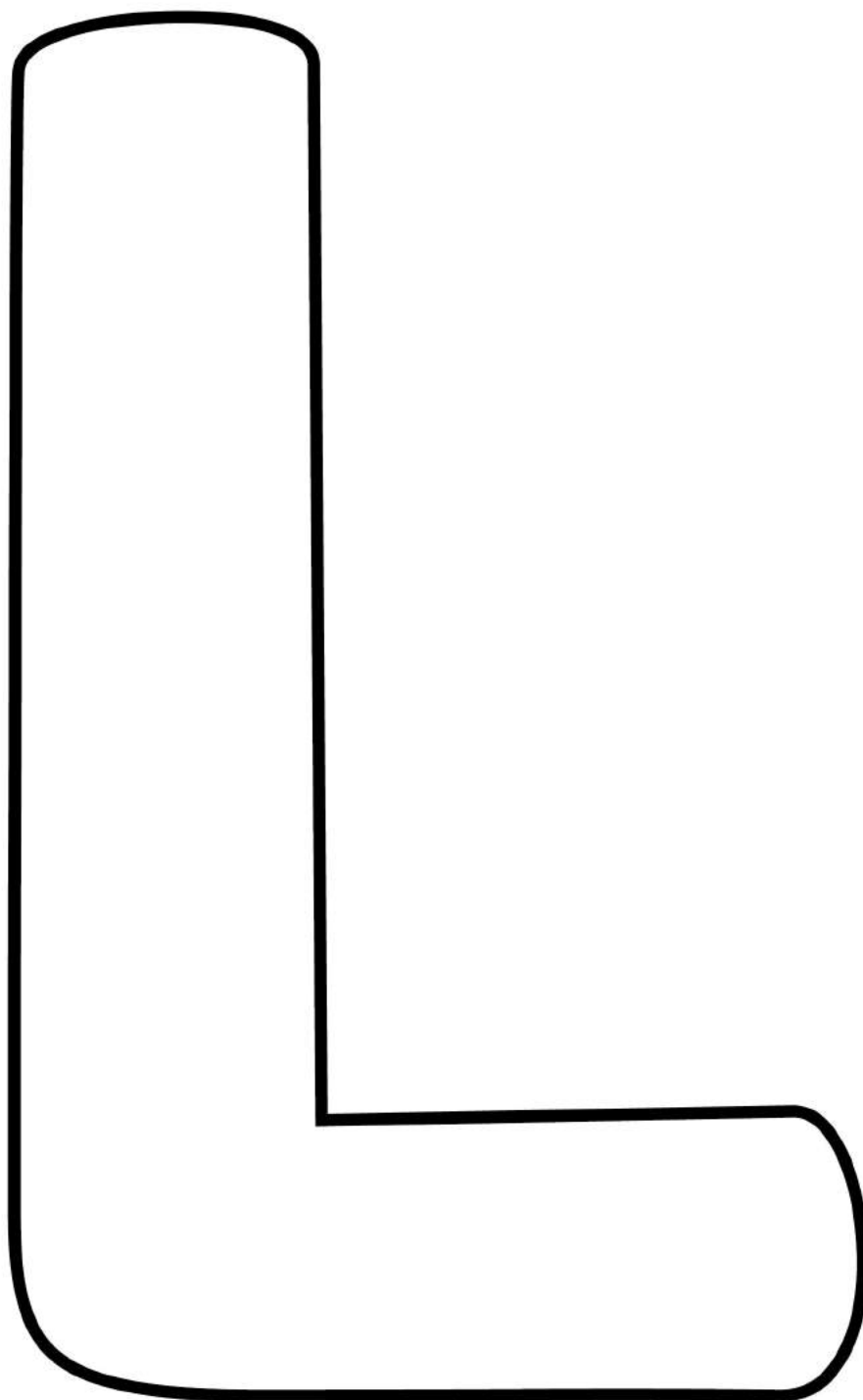

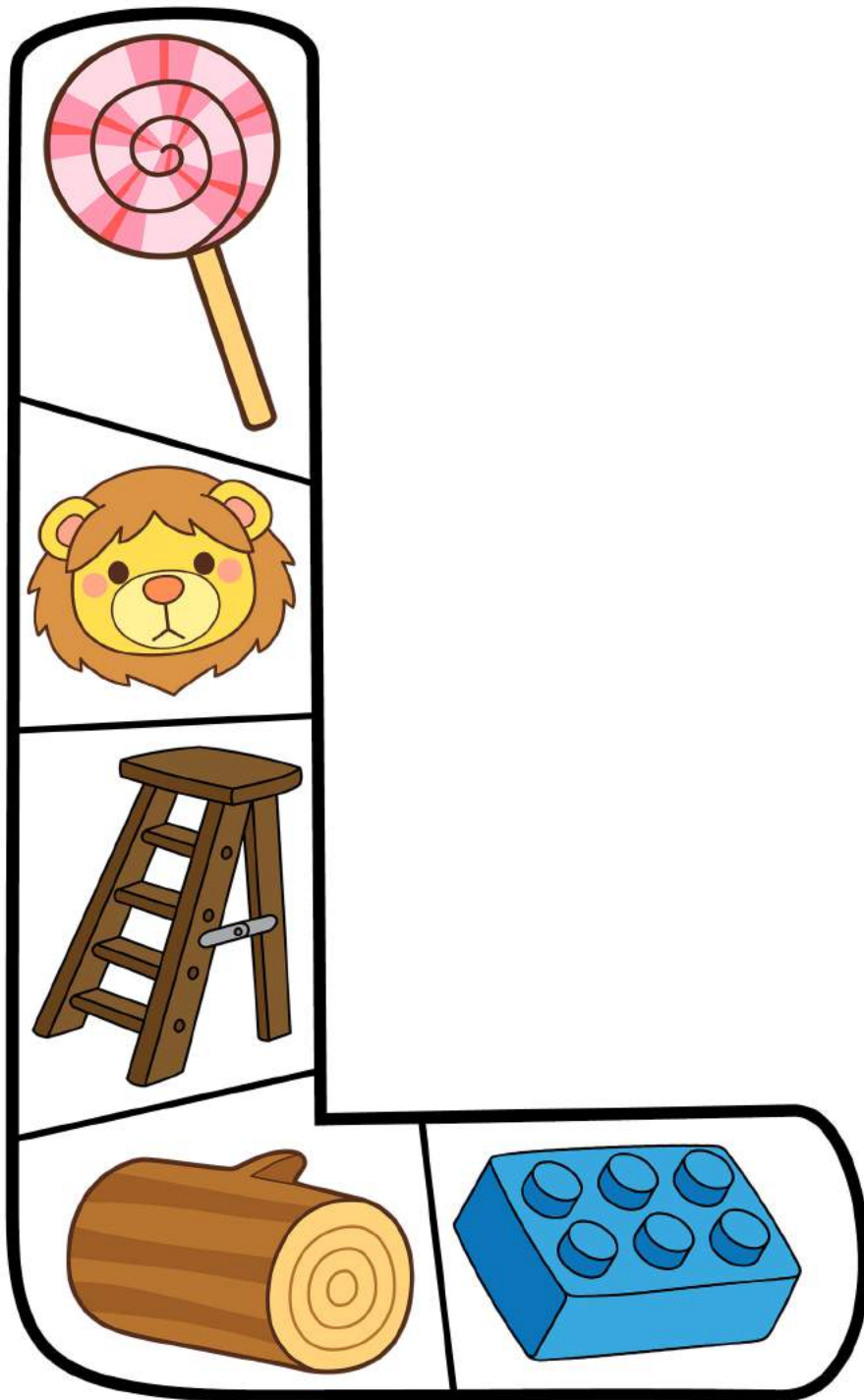

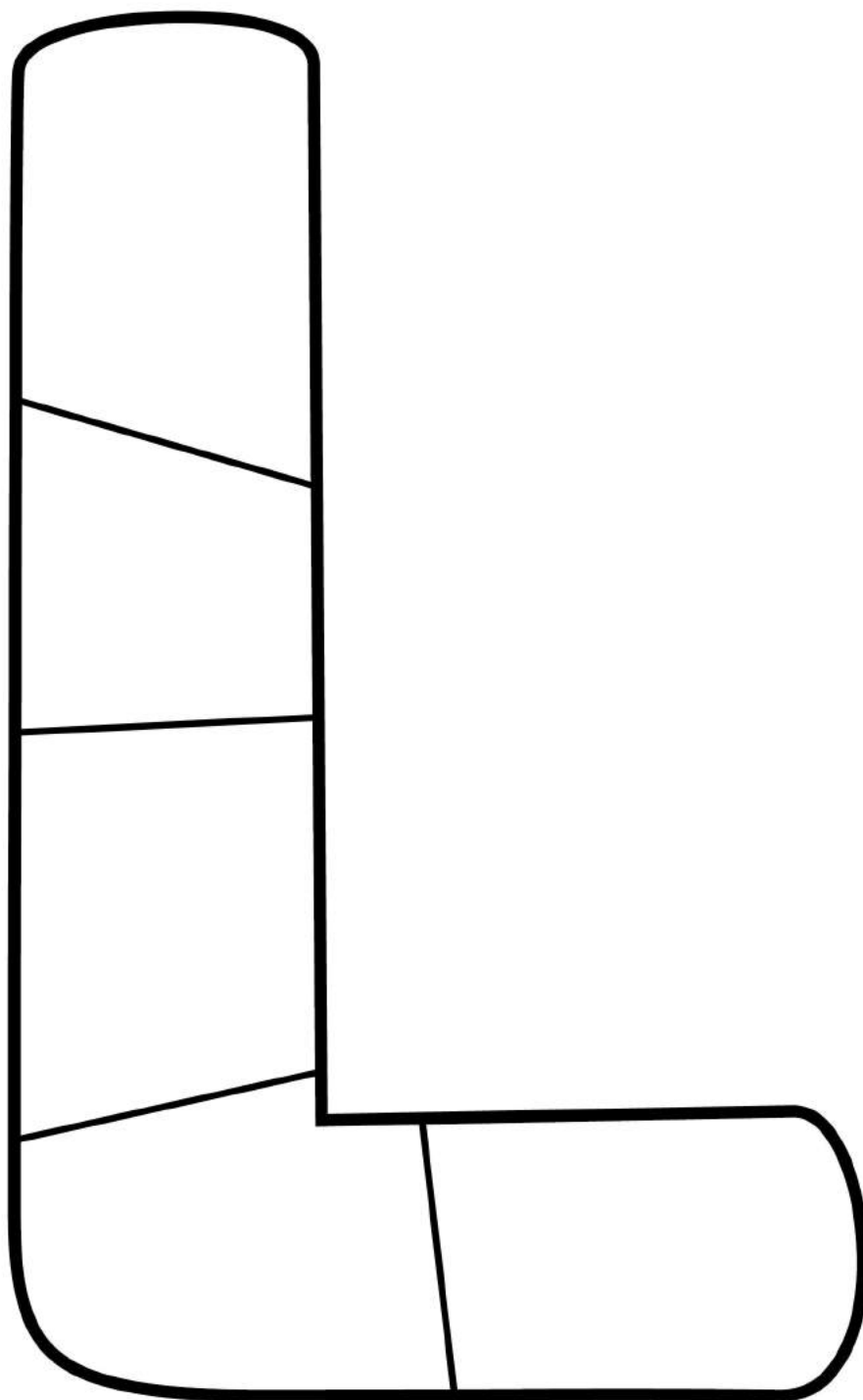

1. Write

2. Cut Out 

NAME : _____

A B C Q U I L T

3. Color

4. Cut out 

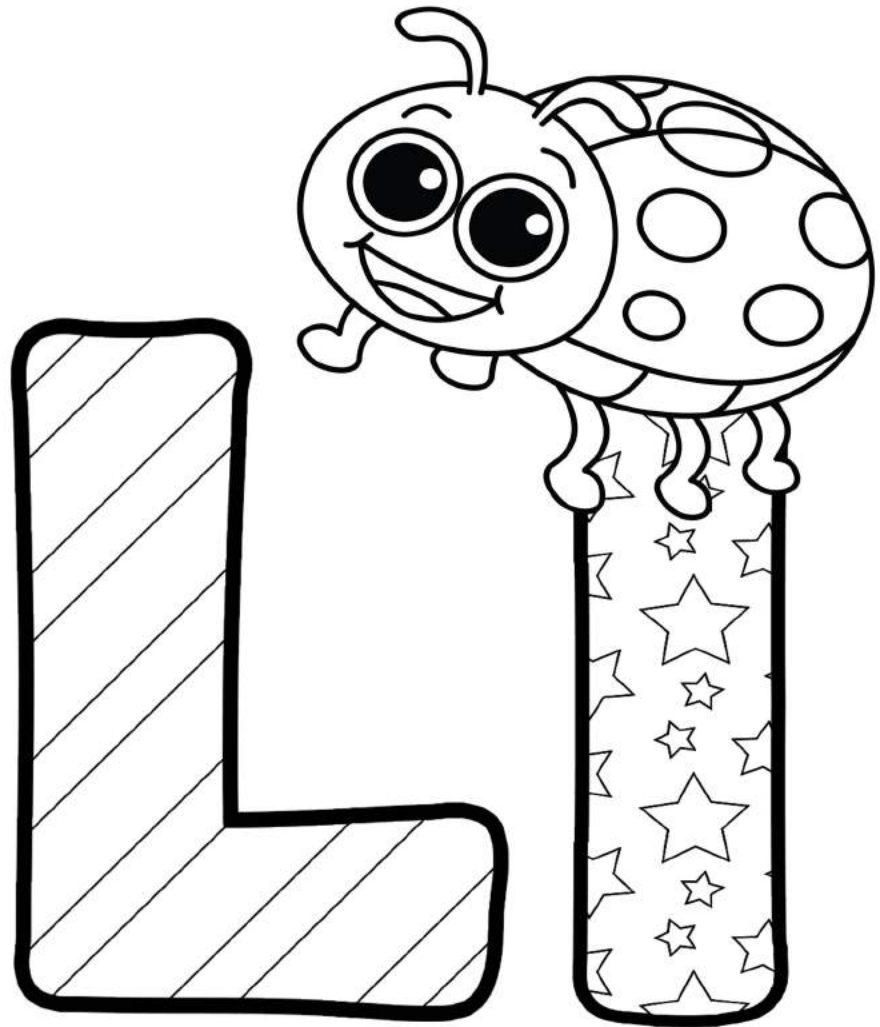

NAME : _____

NAME : _____

LI

Write and read words that begin with letter l.



log log log



lock lock lock



leaf leaf



lion lion lion

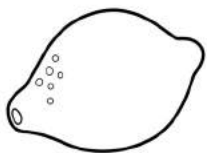

lemon lemon



lamp lamp



lollipop lollipop



lion



leaf



lamp



ladder



lock



lighthouse



lawn mower



lollipop



log

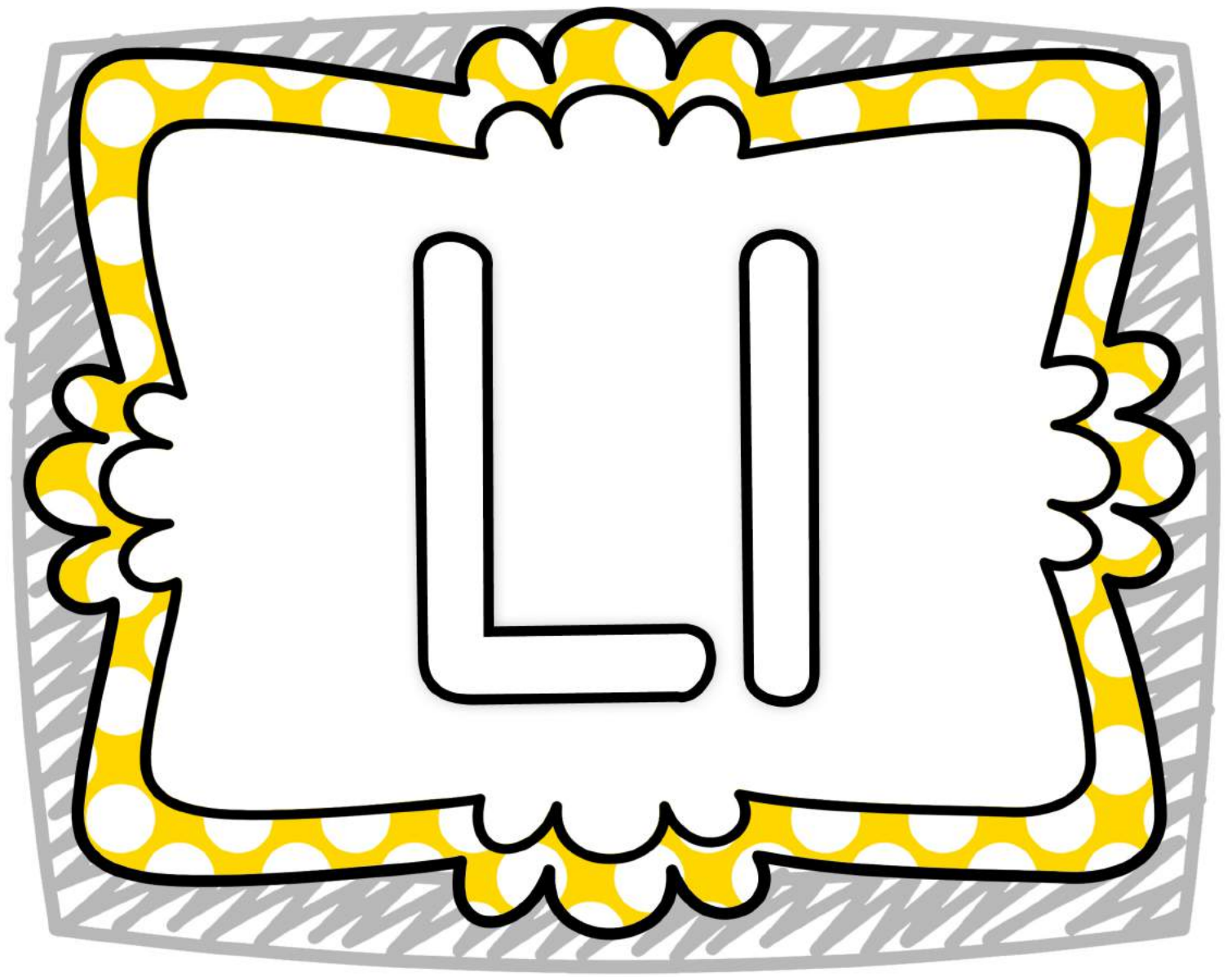

LETTER L















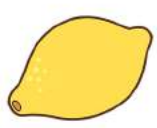

4 IN A ROW

LETTER L

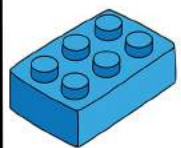

4 IN A ROW















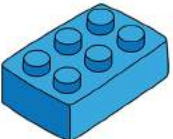

Images (c) Little Red's Clipart, Zip-a-De-Doo-Dah Designs & Miss Giraffe

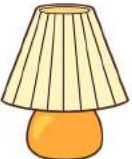
LETTER L















4 IN A ROW

LETTER L



4 IN A ROW

I CAN WRITE

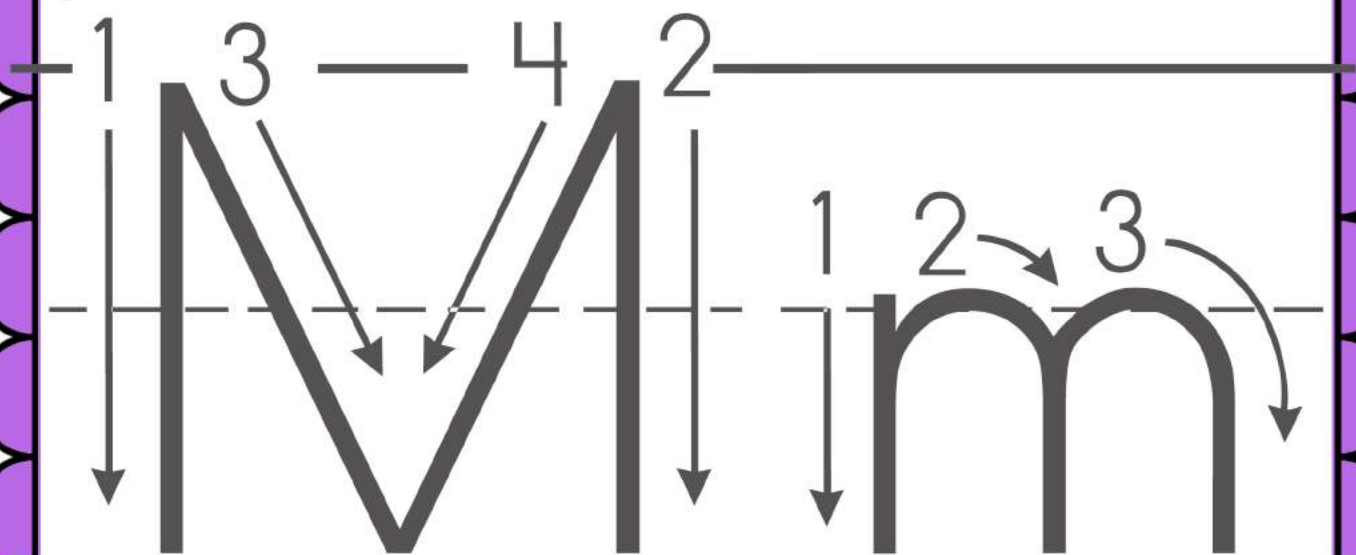

Line Down

Pick Up

Line Down

Pick Up

Slide In

Slide In

Line Down

Pick Up

Jump

Jump

Mushroom

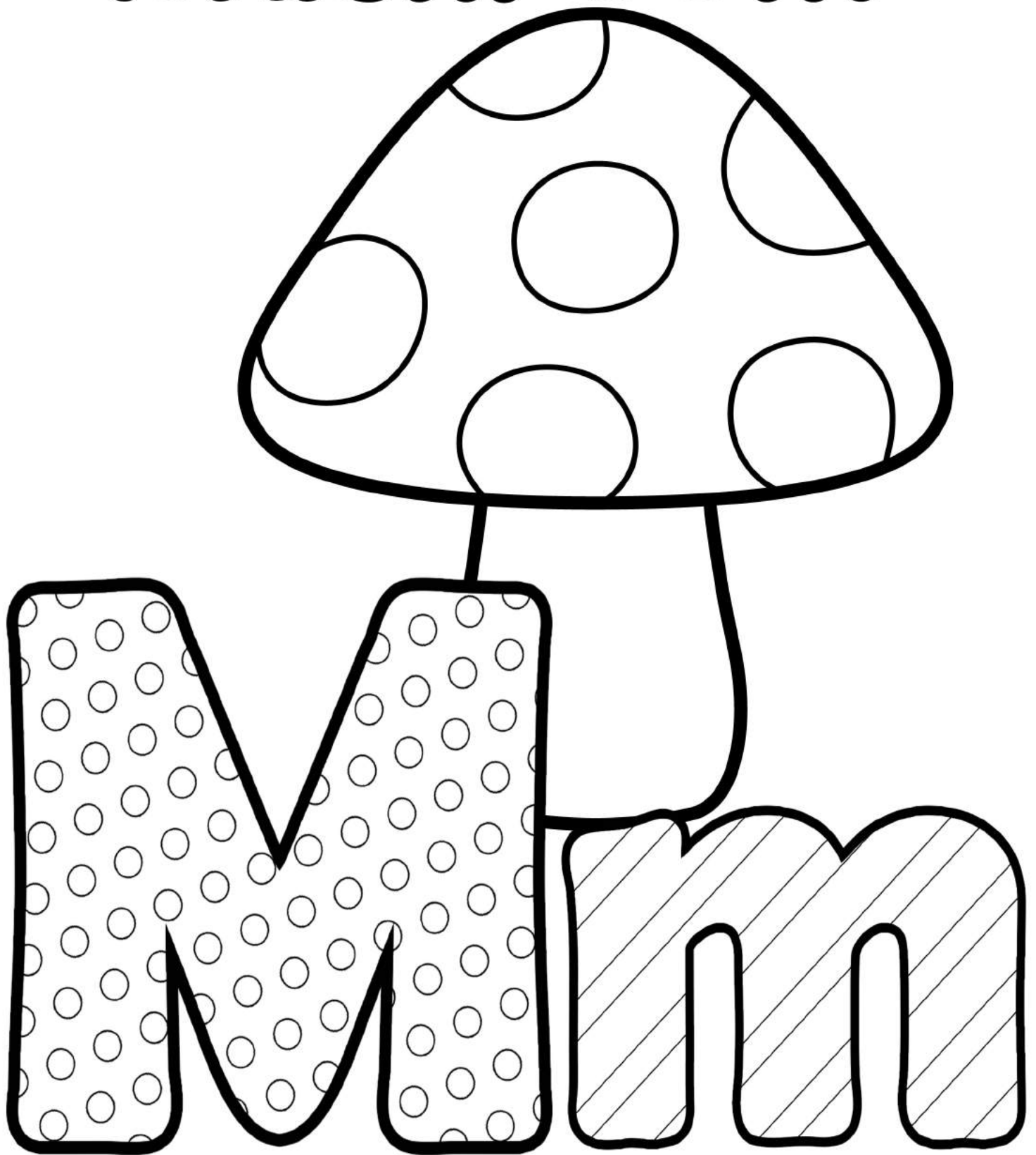

M m

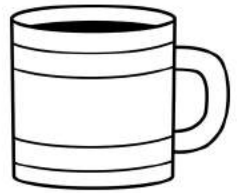
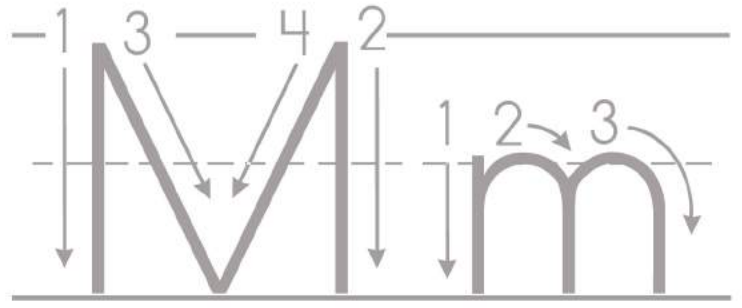

map mushroom mouse money mailbox mug

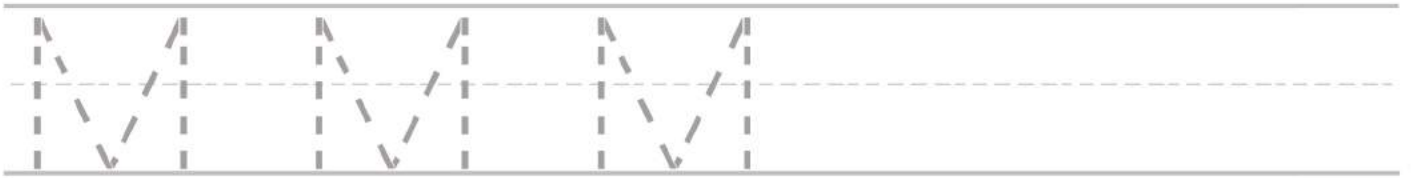
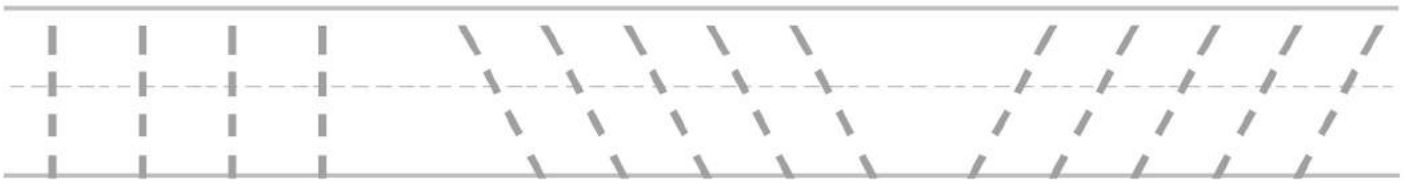

Draw three mice under the magnifying glass



Deliver the mail to the correct mailbox:

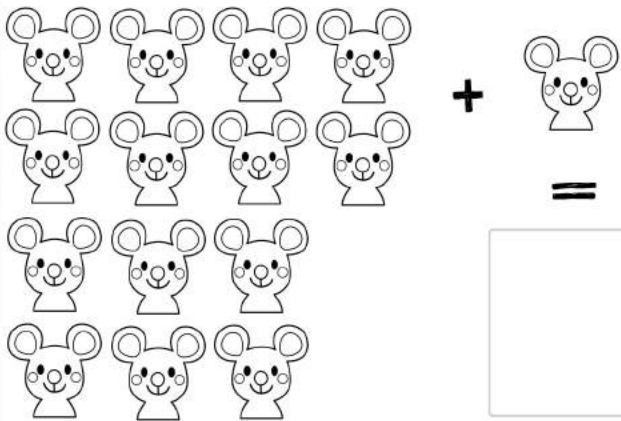
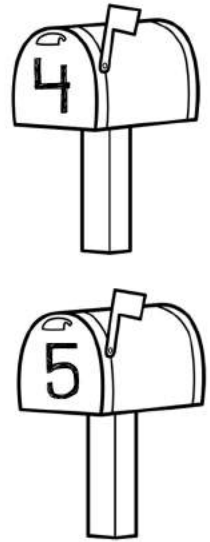
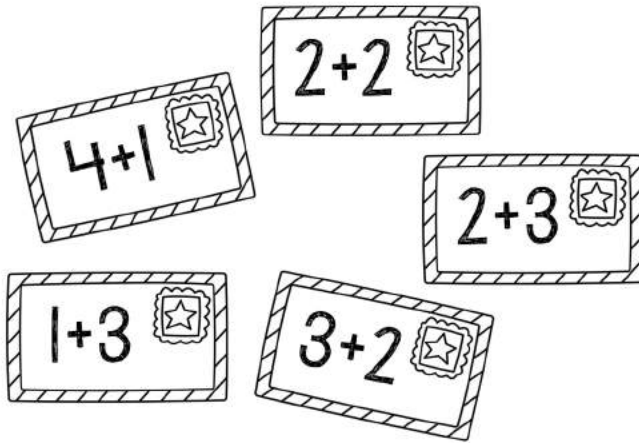

$$14 + 1 = \square$$

$$14 + 2 = \square$$

$$\begin{array}{r} 14 \\ + 1 \\ \hline \square \end{array} \quad \begin{array}{r} 14 \\ + 2 \\ \hline \square \end{array}$$

Draw a martian on the moon.
Draw a star on the right.
Draw a planet on the left.
Draw a ring around the planet.

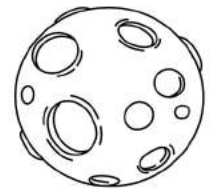

Cross out the different mushroom

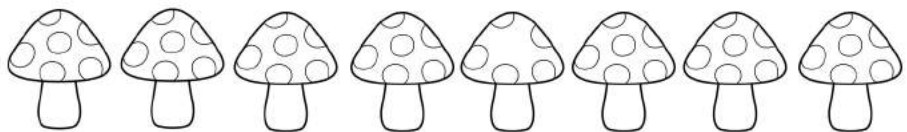

Draw: $14 + 1 = 15$
 $\quad \quad \quad + \quad \quad =$

M m

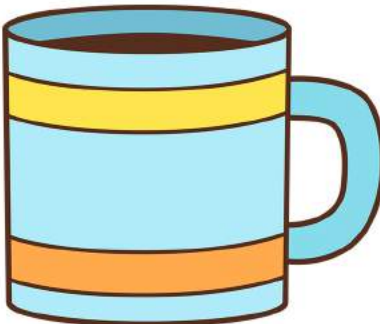
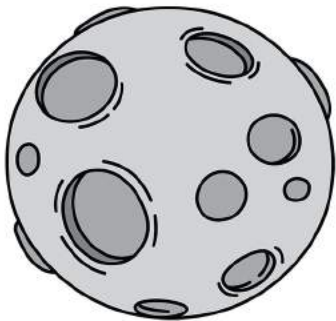

I CAN COLOR

● = mushroom

● = map

words with:

● = mailbox

● = markers

● = mug

● = mermaid

● = money

● = moon

● = mouse

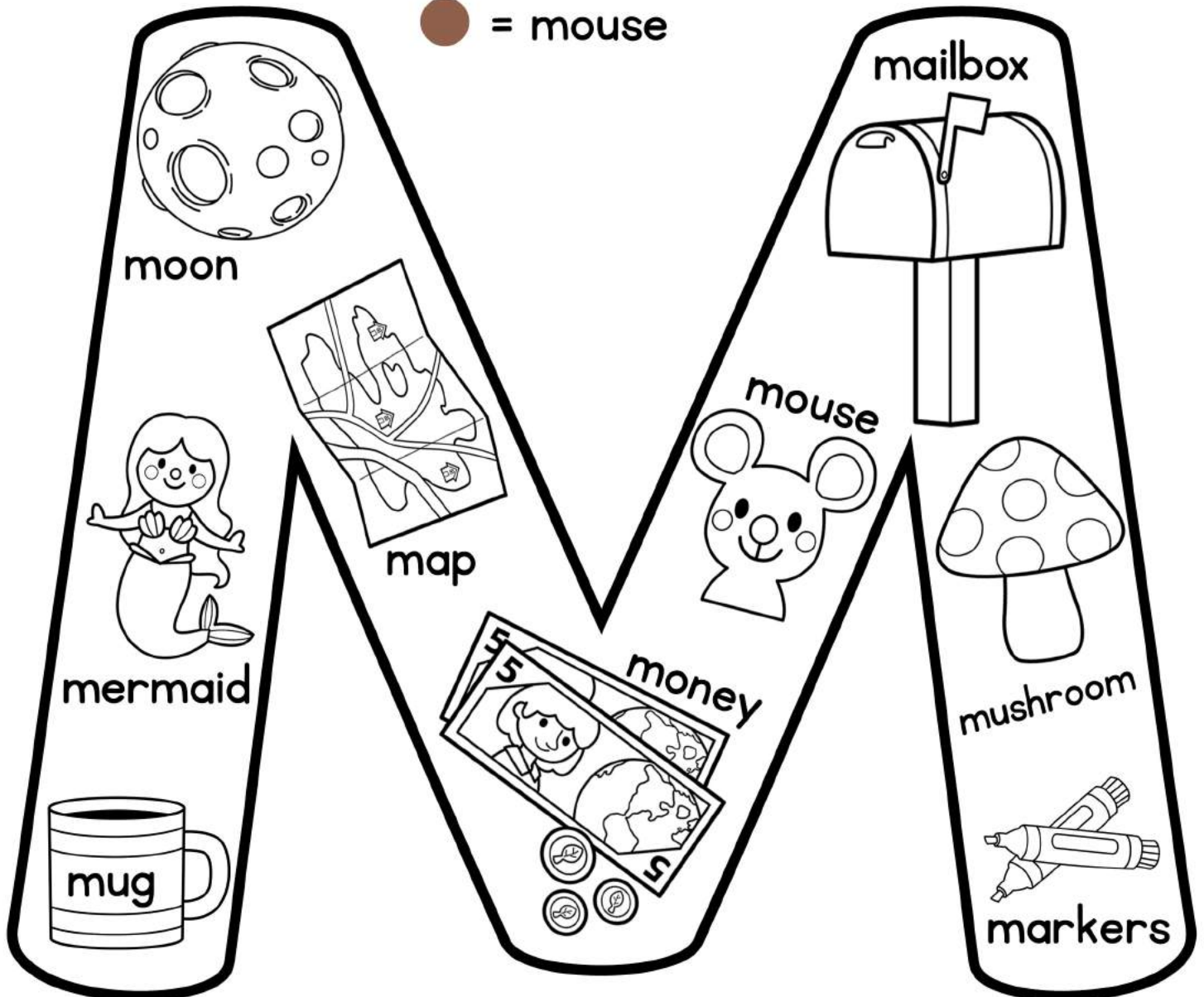

NAME : _____

Mm

Write and read words that begin with letter m.



map map

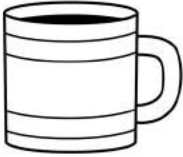

mug mug



mop mop



mouse mouse



mitten mitten



money money



mushroom

NAME : _____

Mm

Write and read words that begin with letter m.



Map Map

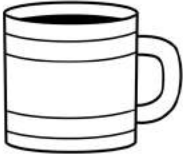

Mug Mug



Mop Mop



Mouse



Mitten



Money



Mushroom

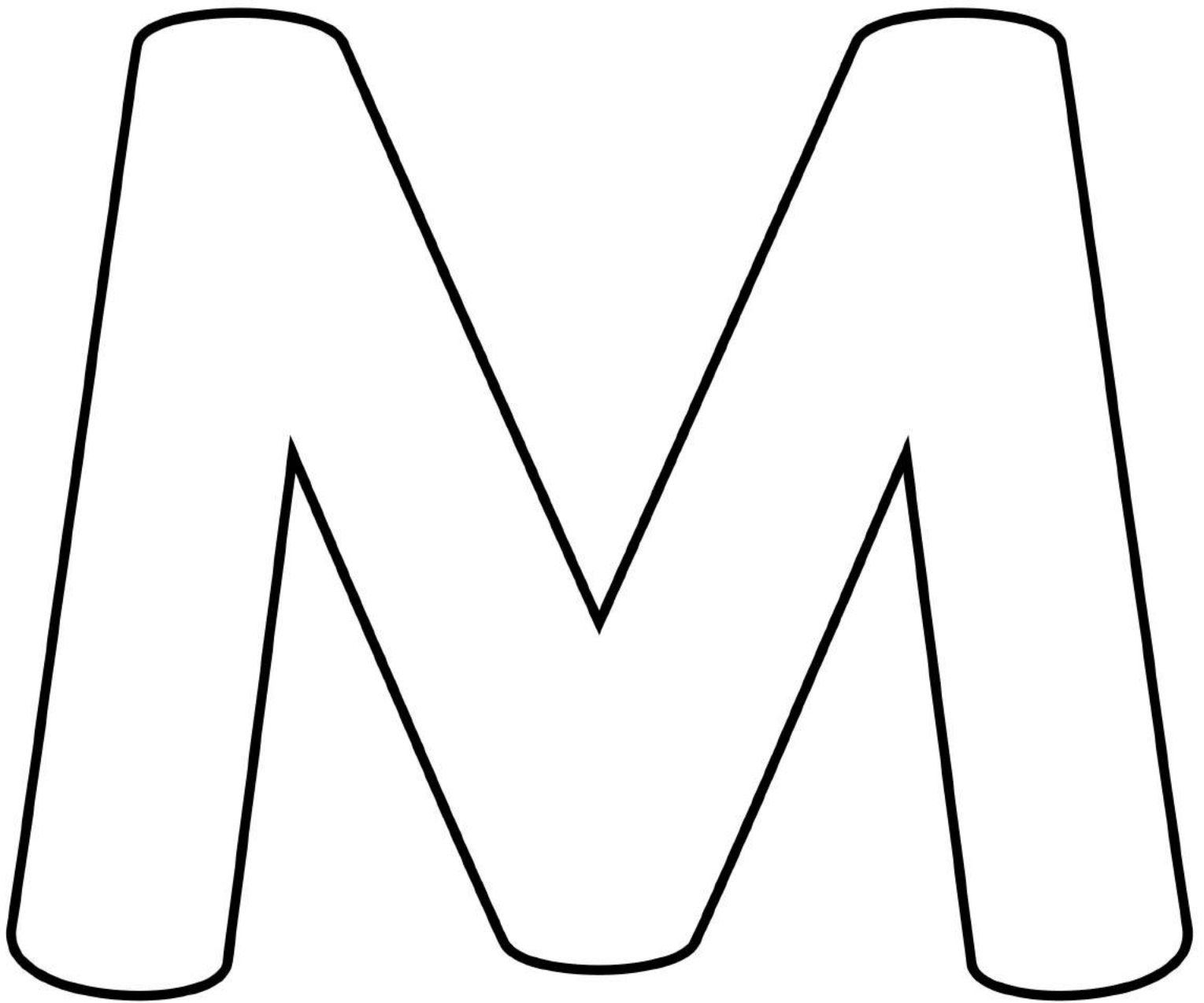

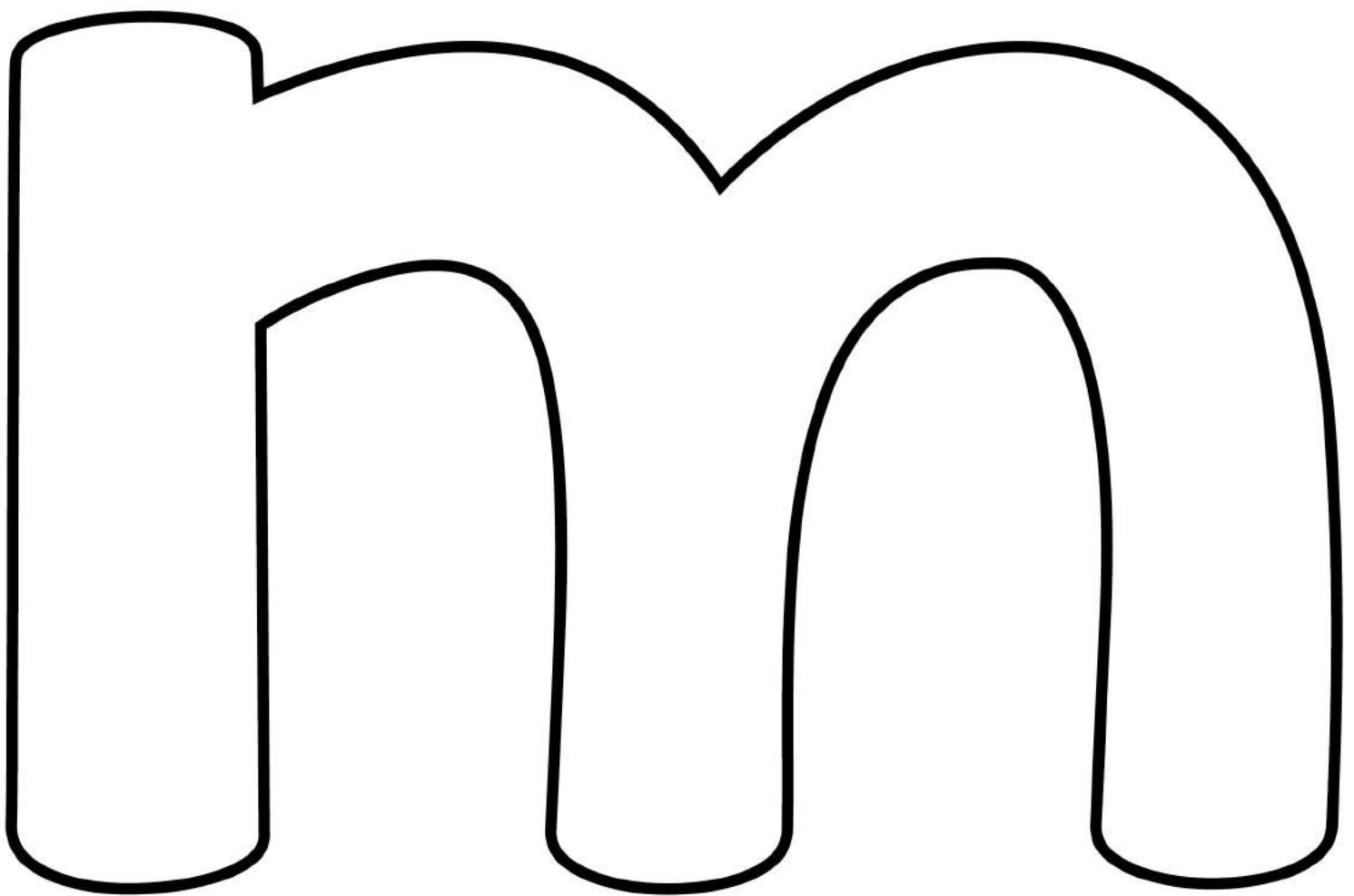

Mm

★ I ★

★ C ★ ★ A ★ ★ N ★

★ F ★ ★ I ★ ★ N ★ ★ D ★

the letter:

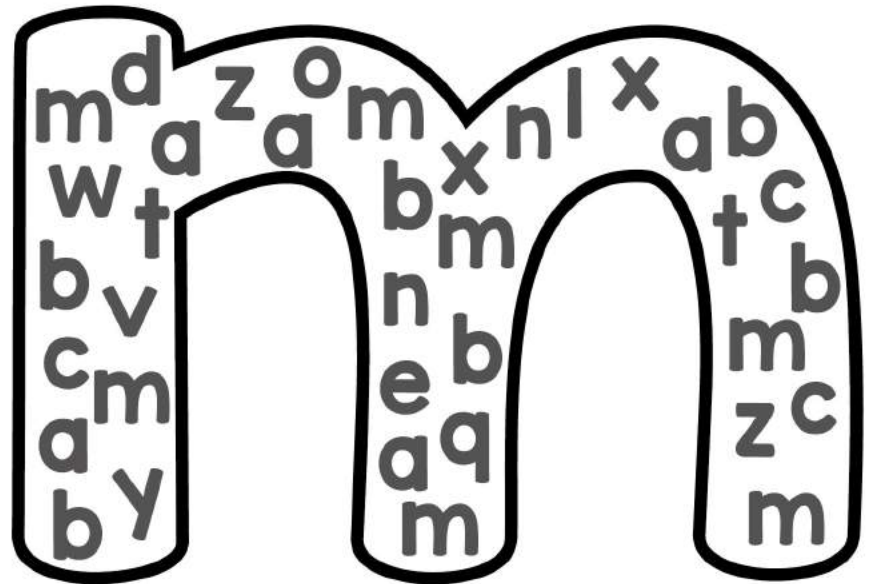
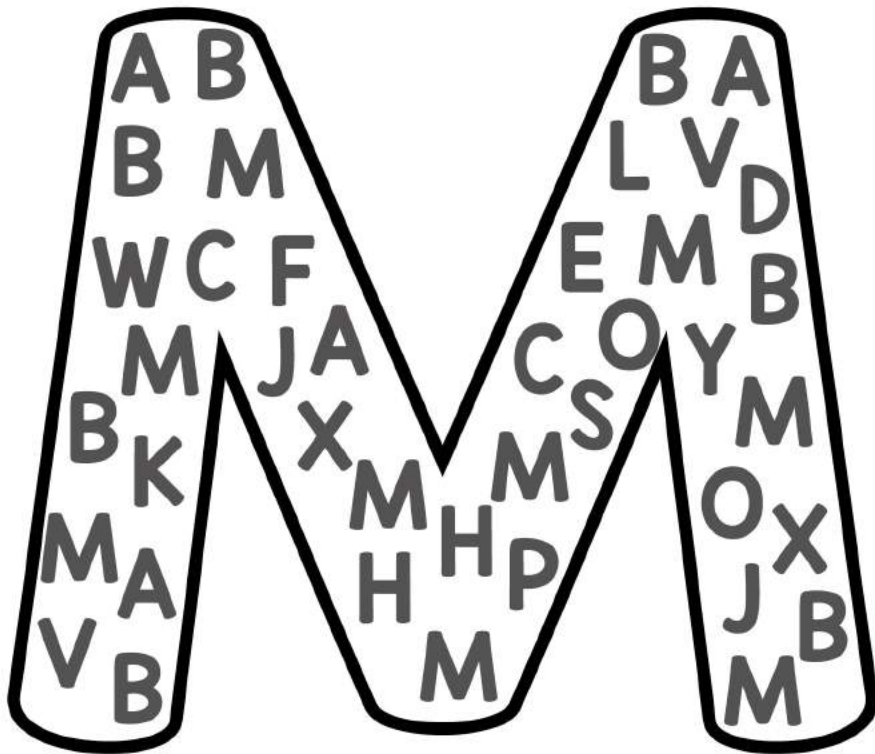

How Many?

How Many?

TRACE

NAME : _____





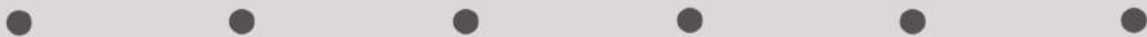
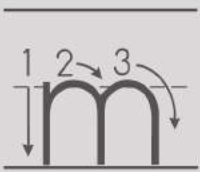
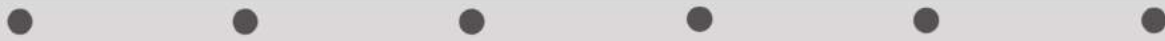
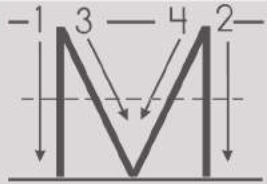

Color one for each row of letters you complete



C · O · U · N · T



G · R · A · P · H

M	m					



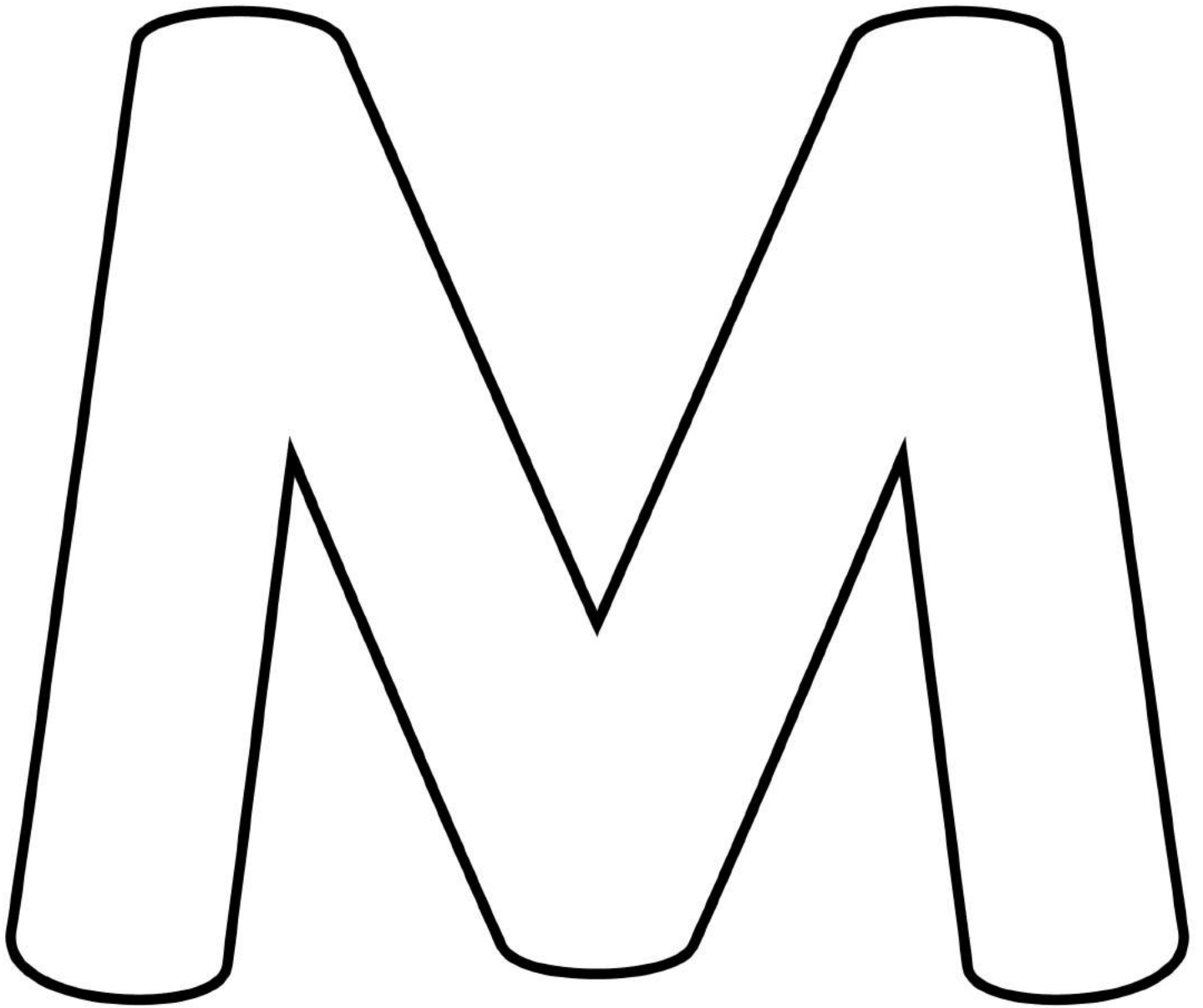



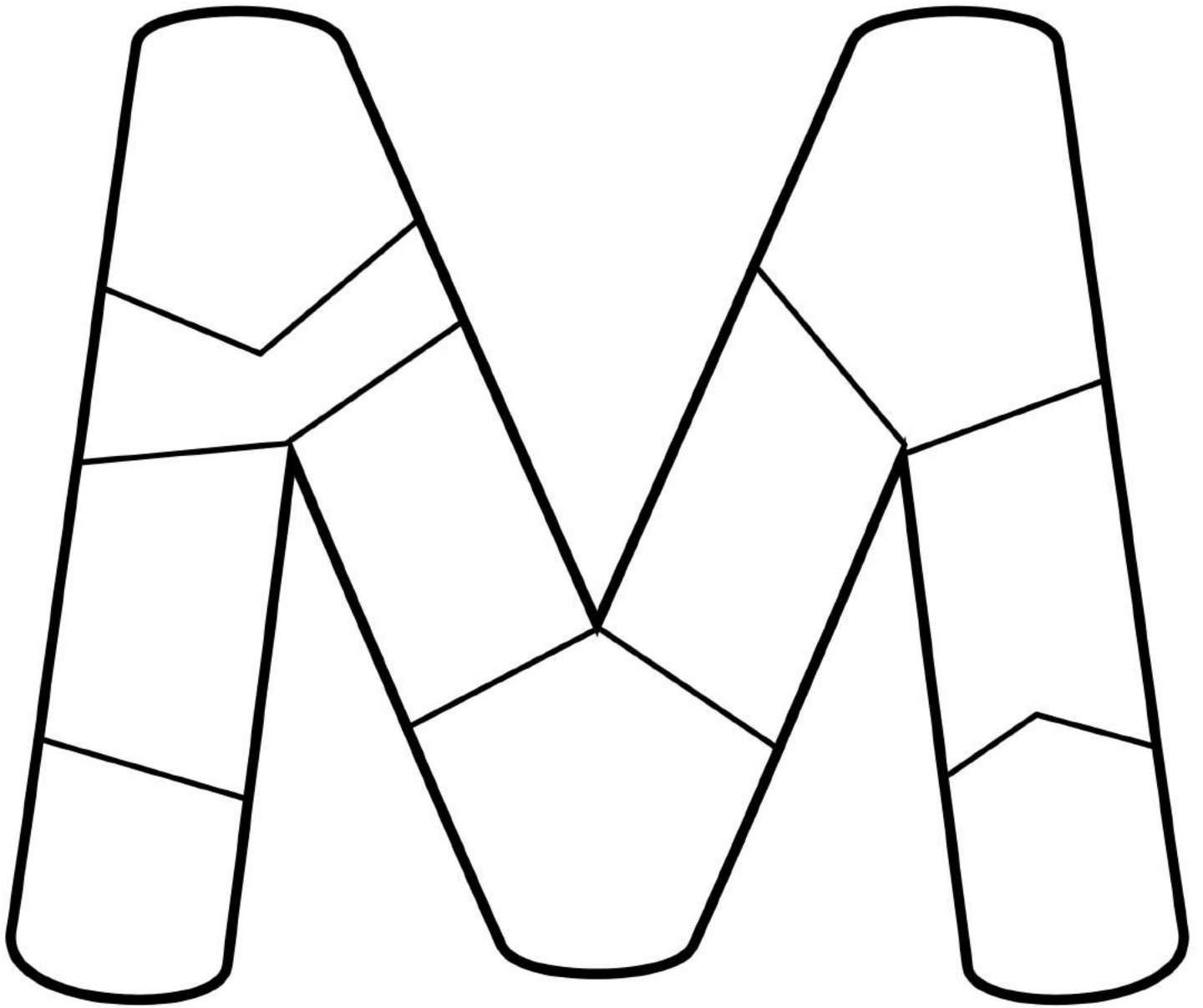

1. Write

2. Cut Out 

NAME : _____

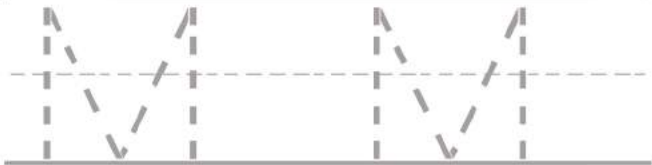

A B C Q U I L T

3. Color

4. Cut out 

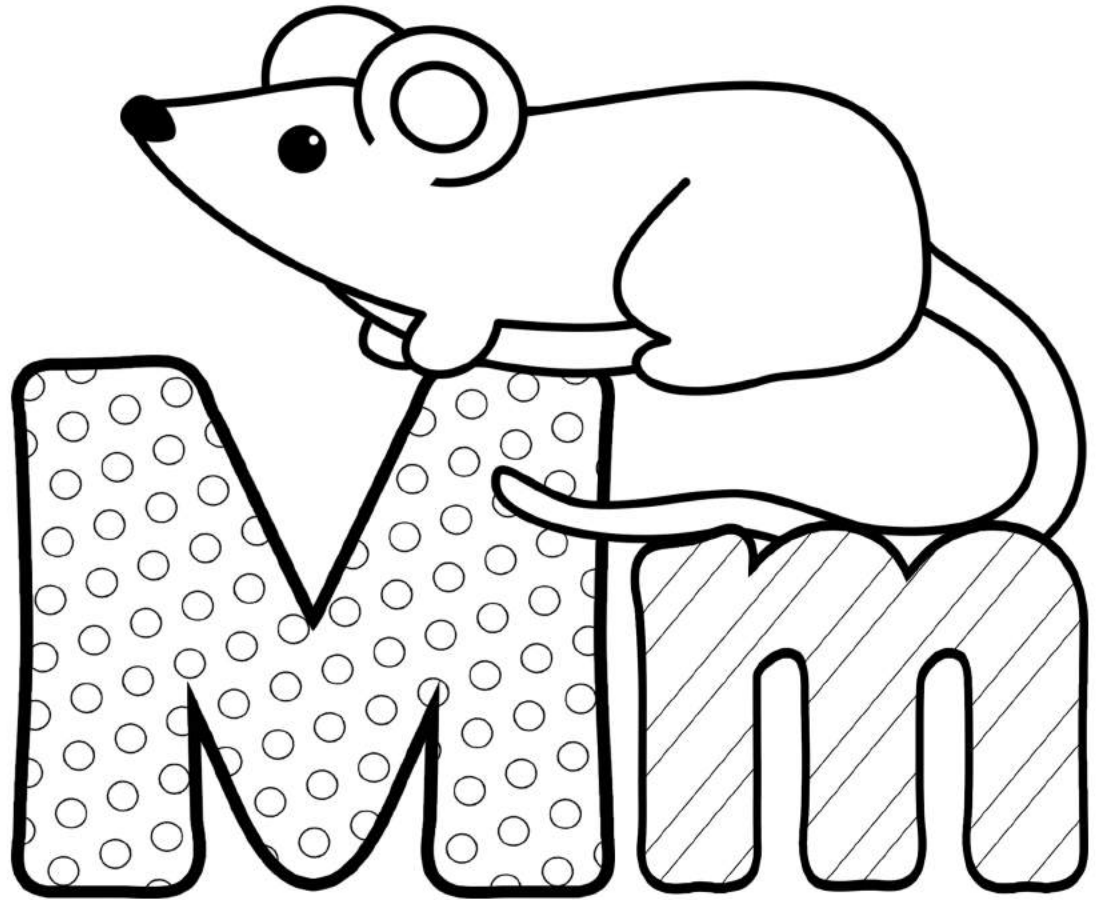

NAME : _____

NAME : _____

Mm

Write and read words that begin with letter m.



map map map

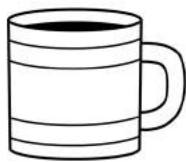

mug mug mug

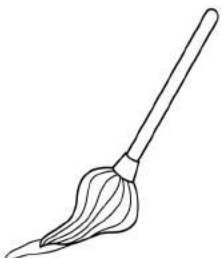

op op op



ouse ouse



itten itten



oney oney



ushroom



mermaid

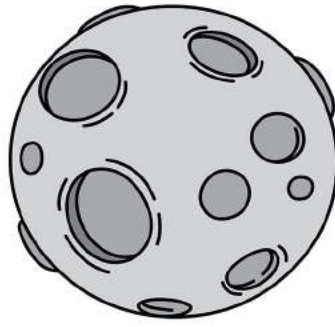

moon



mushroom



mouse



mailbox



map

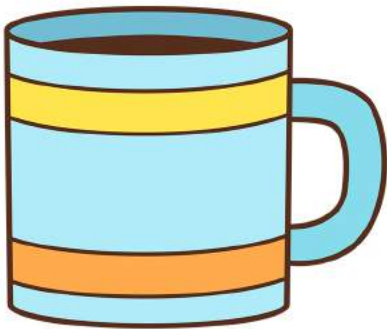

mug



money



mitten

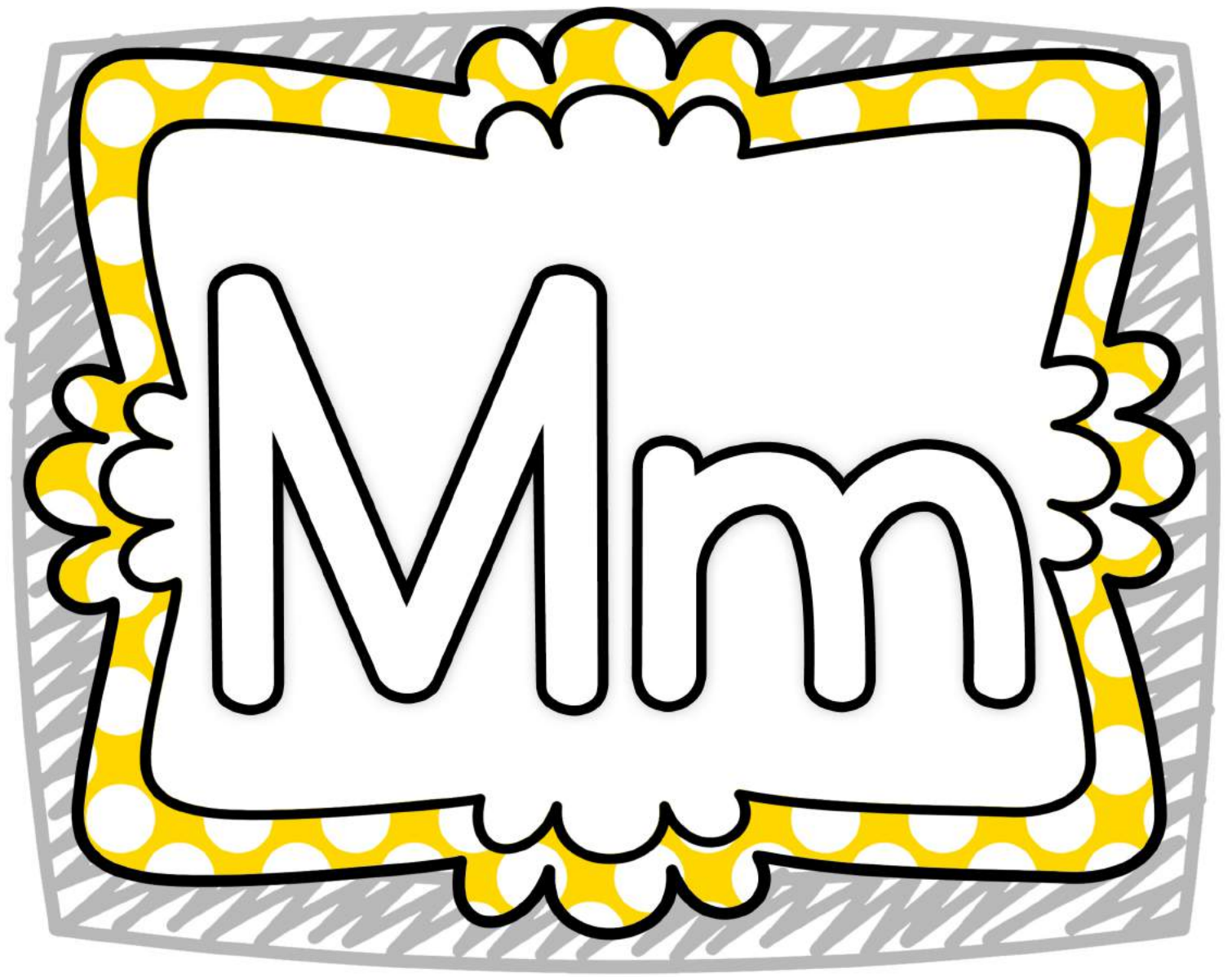

LETTER M



4 IN A ROW

LETTER M



4 IN A ROW

LETTER M



4 IN A ROW

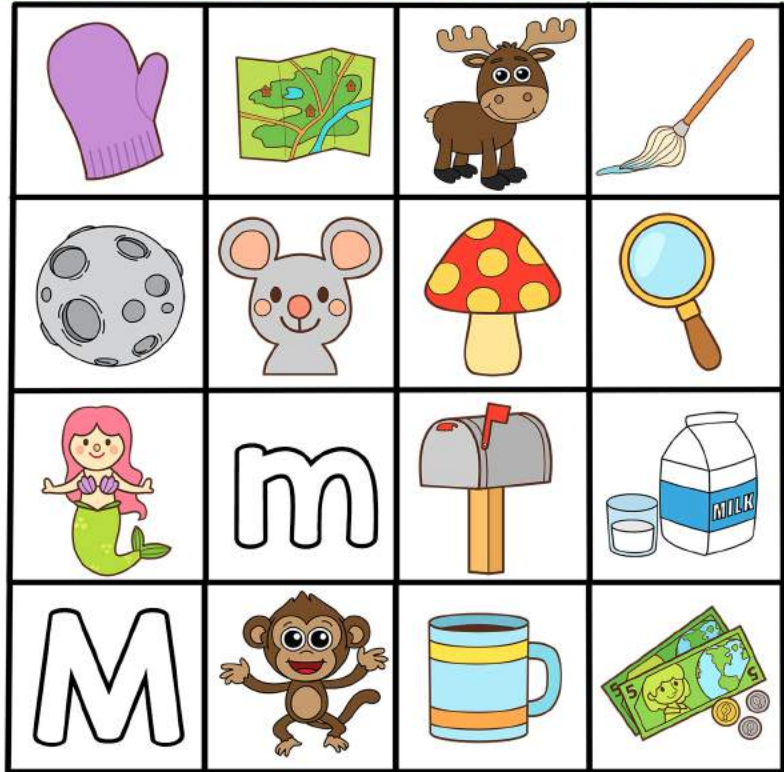

LETTER M



4 IN A ROW



I C A N W R I T E

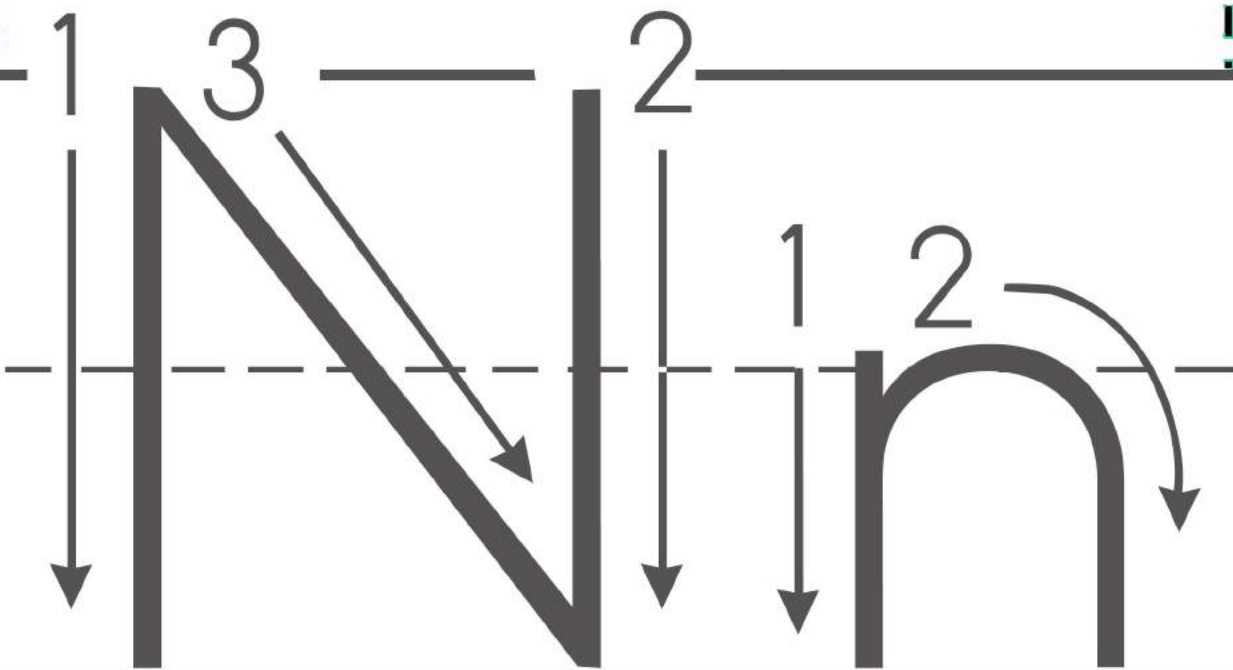

Line Down

Pick Up

Line Down

Pick Up

Slide Across

Line Down

Pick Up

Jump

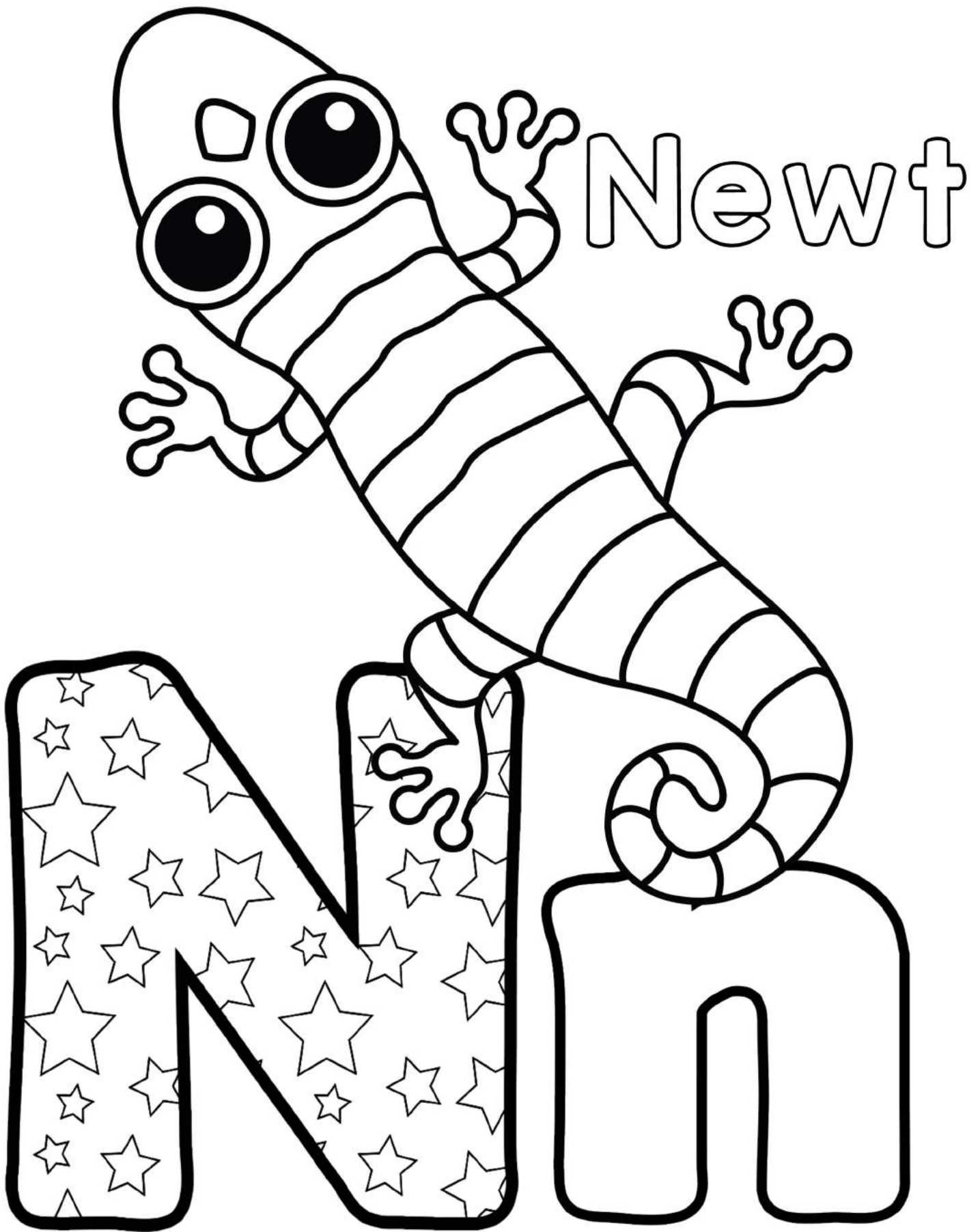

N n

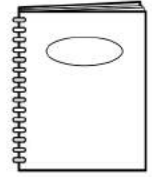
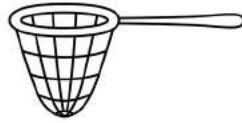
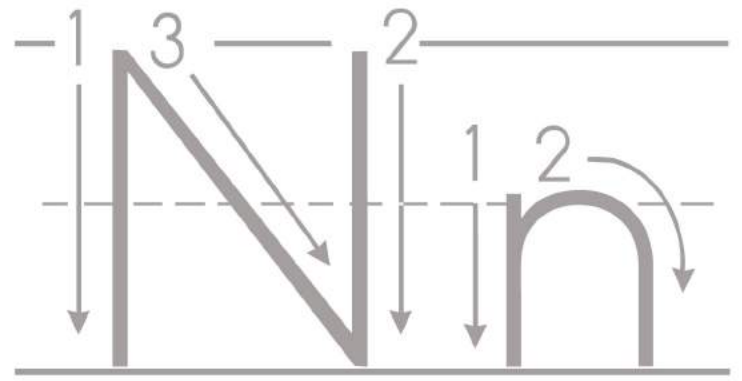

newt

newspaper

net

nest

notebook



Draw nine eggs in the nest:

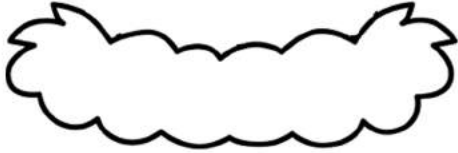

Measure:

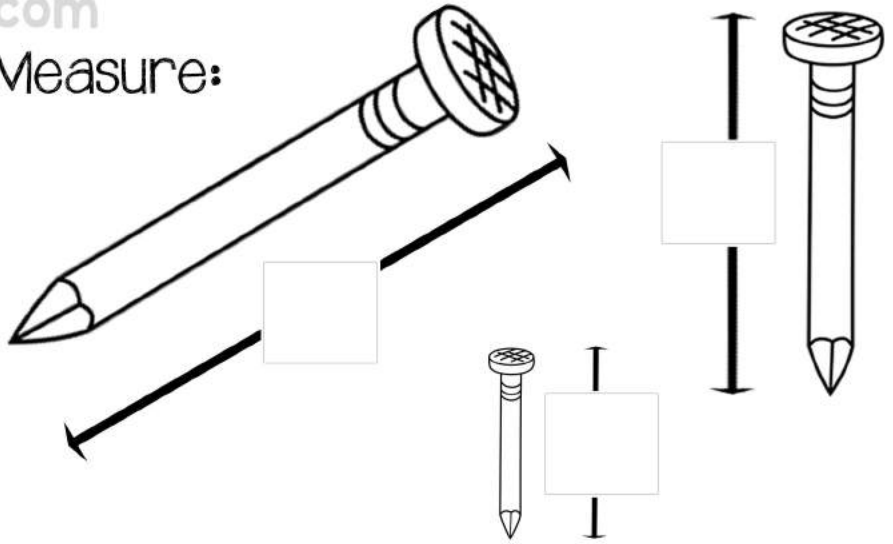

Subtract

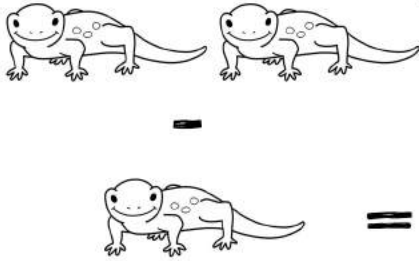

Count & Tally the nuts:

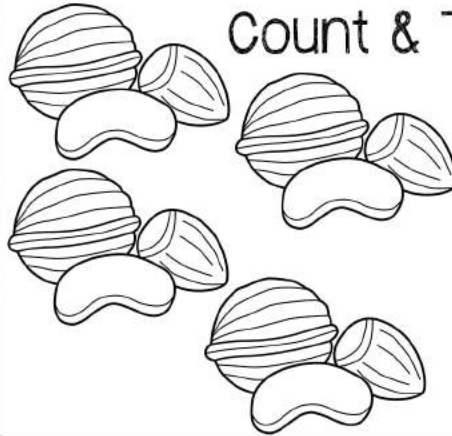

$$2 - 1 = \square$$

$$1 - 1 = \square$$

$$\begin{array}{r} 2 \\ - 1 \\ \hline \square \end{array} \quad \begin{array}{r} 1 \\ - 1 \\ \hline \square \end{array}$$

Cross out the different notebook

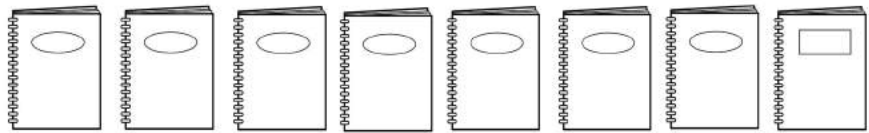

Color the 3rd, 6th, 9th, and 11th newt:

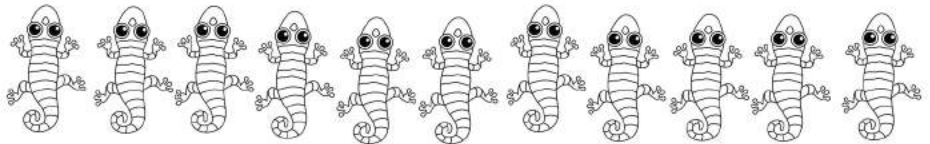

Draw: $2 - 1 = 1$
 $2 + 1 =$

Nn

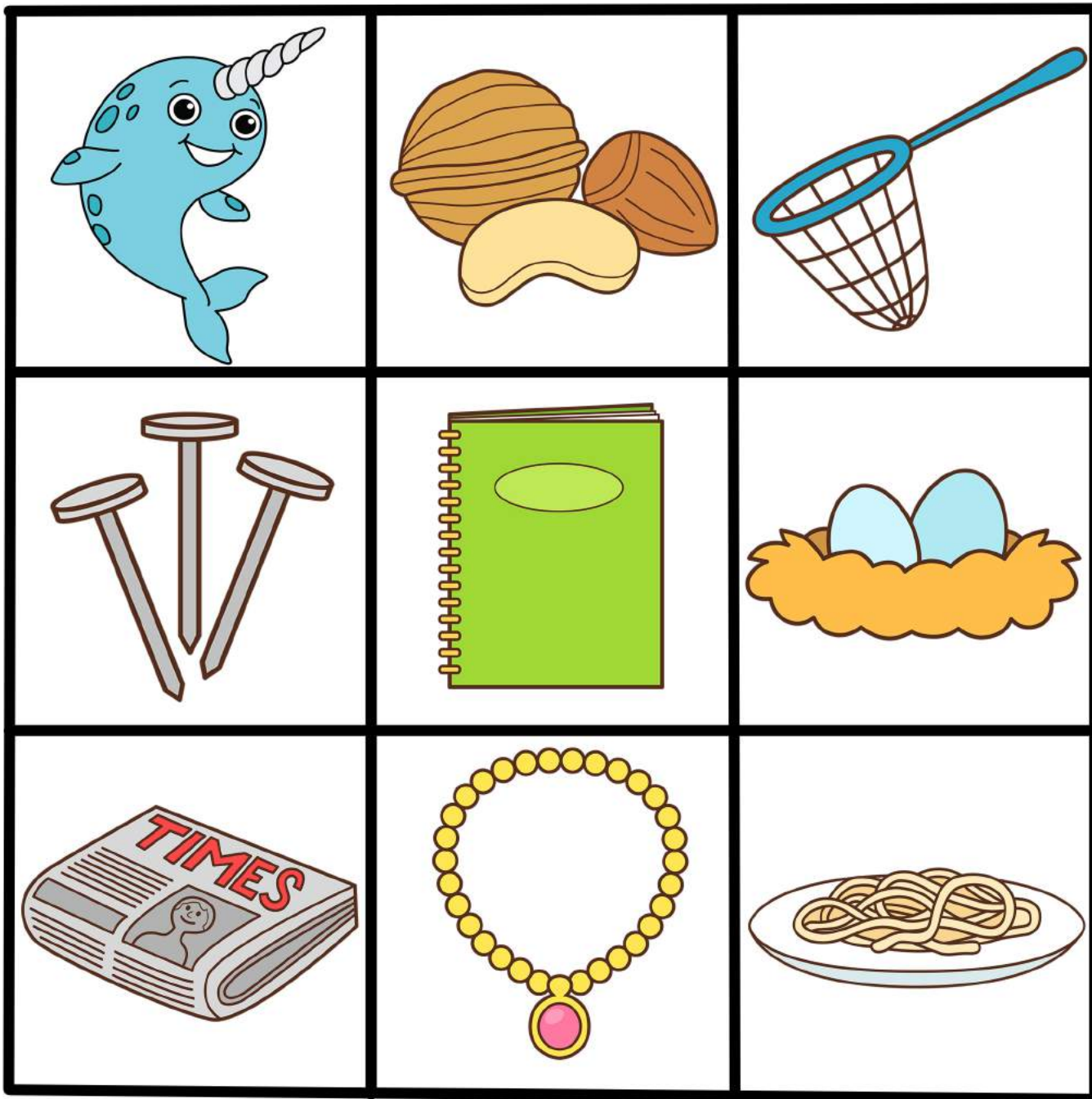
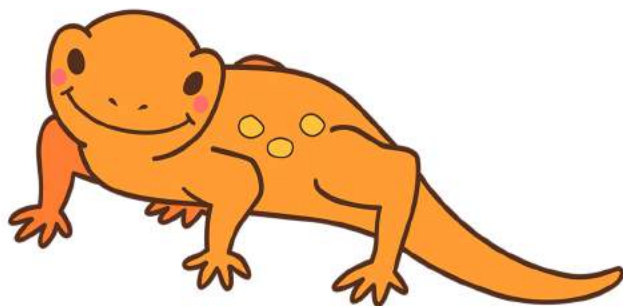

I CAN COLOR

words with:

● = nurse

● = nuts

● = newt

● = narwhal

● = notebook

● = net

● = nest

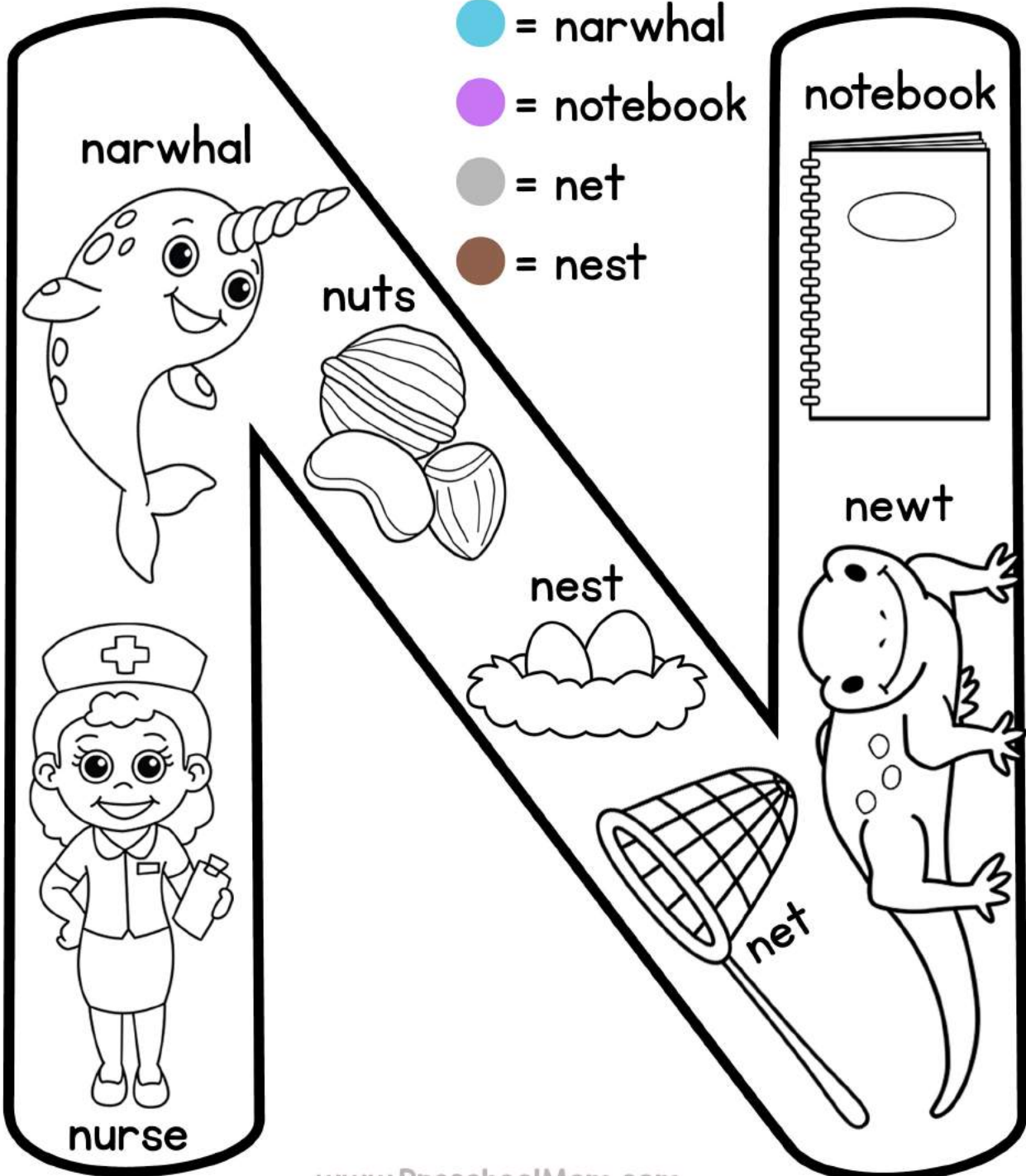

NAME : _____

Nn

Write and read words that begin with letter n.



net net net



nest nest



nuts nuts



nose nose



nails nails



note note

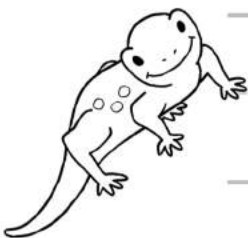

newt newt

NAME : _____

Nn

Write and read words that begin with letter n.



Net Net Net



Nest Nest



Nuts Nuts



Nose Nose



Nails Nails



Note Note

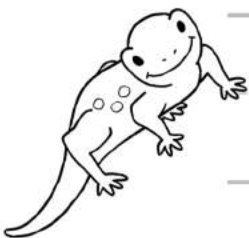

Newt Newt

NAME : _____

RACE TO THE TOP

Use a paperclip and a pencil to complete the spinner.

N	n
N	n
N	n
N	n
N	n
N	n
N	n
N	n
N	n
N	n

SPIN



Record

Report:

How many spins landed on N?

How many spins landed on n?

Which had more?

Write an inequality: **>**

How many spins total?

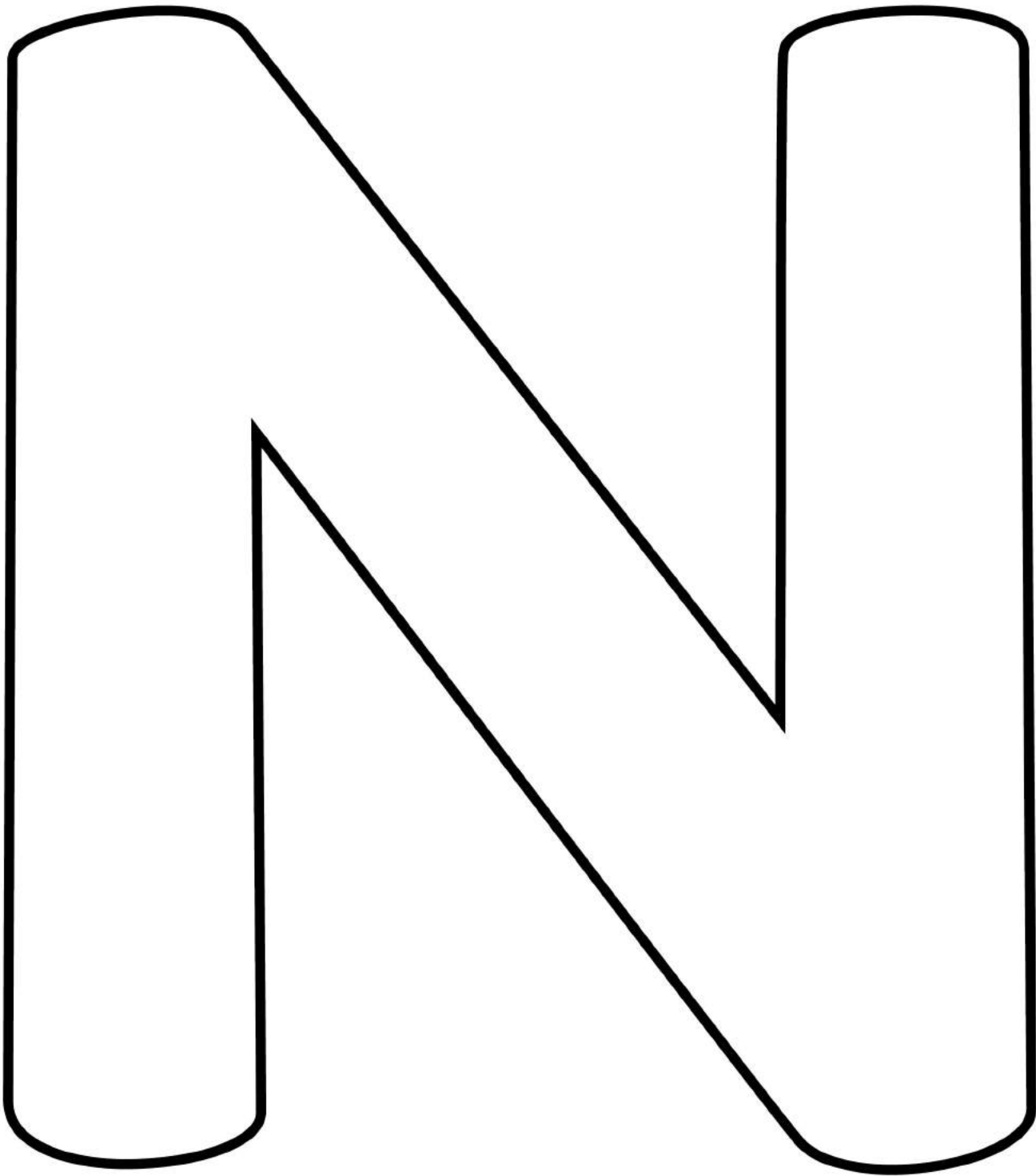

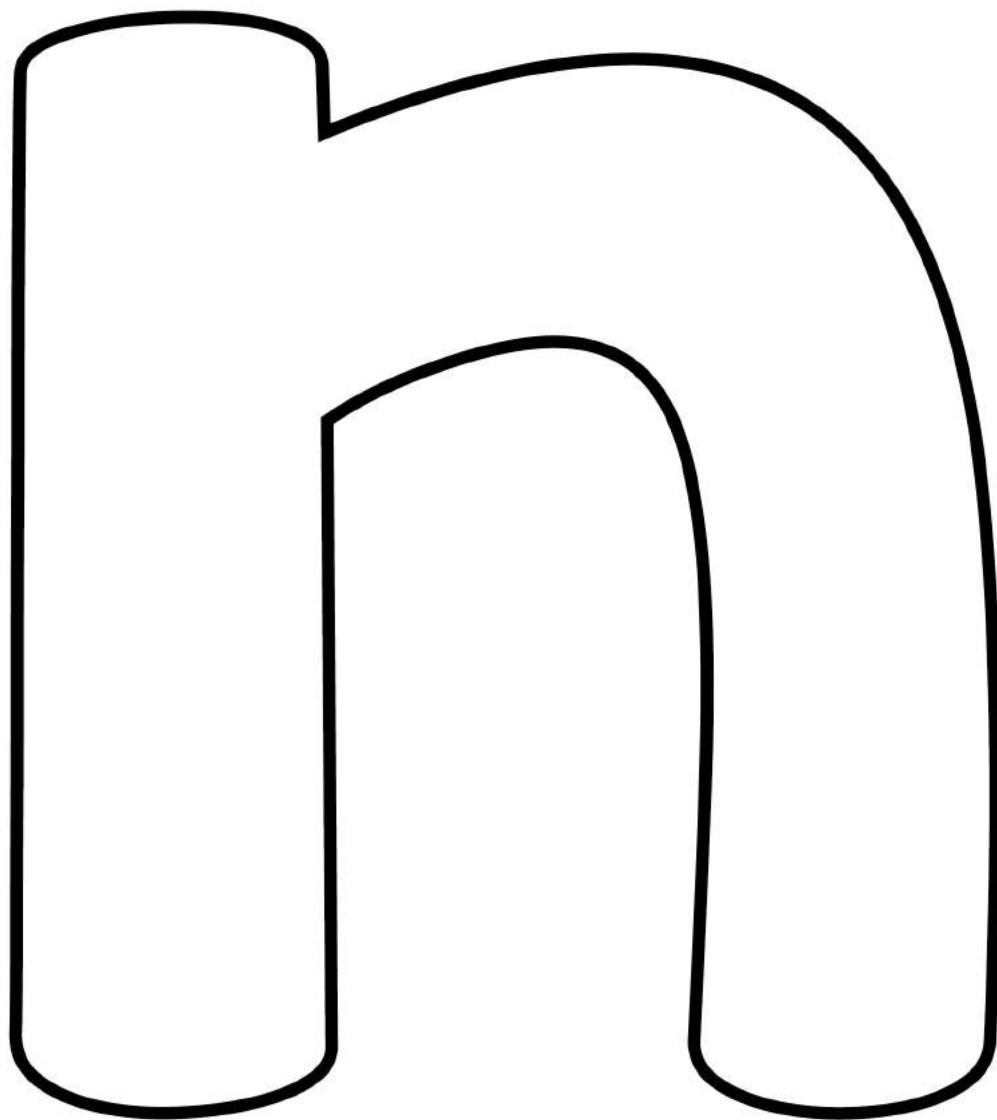

N n

I C A N F I N D

the letter:

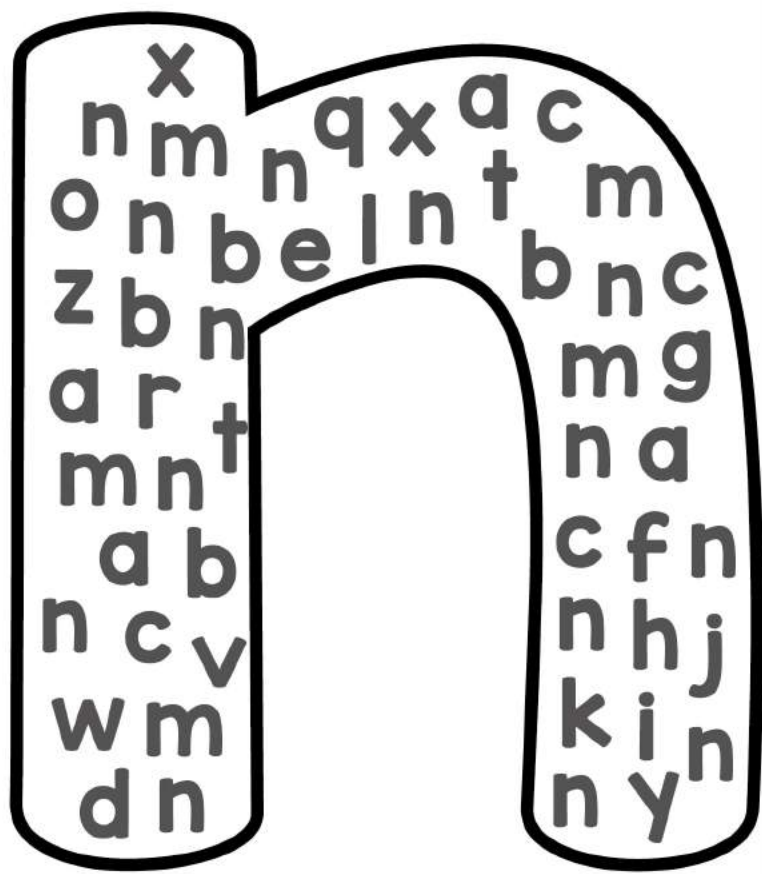
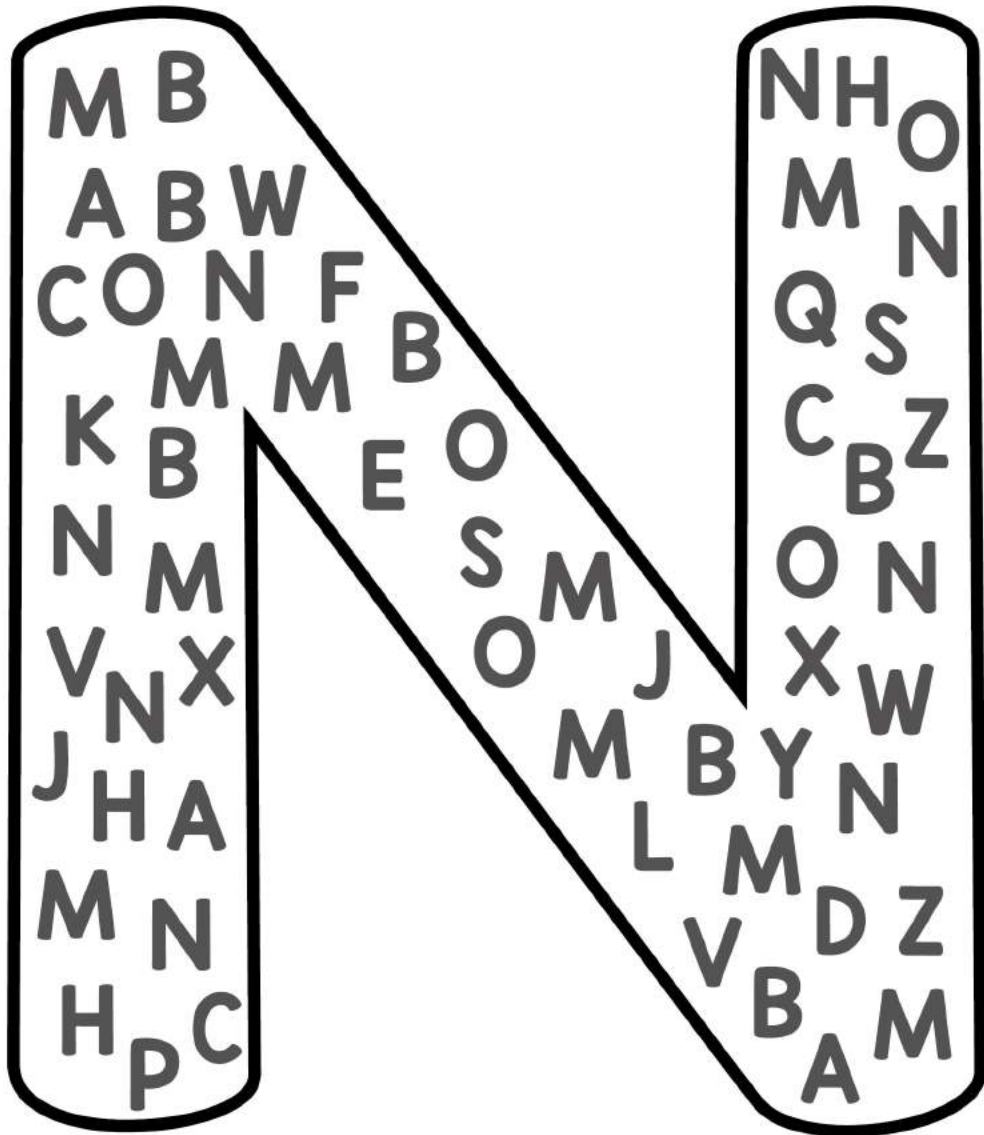

How Many?

How Many?

TRACE

NAME : _____



Color one for each row of letters you complete

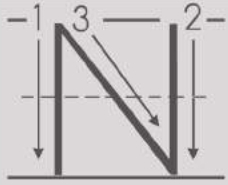

N N N N N N N

N N N N N N N

N N N N N N N

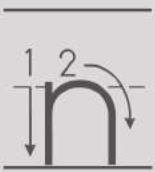

n n n n n n n

n n n n n n n n





n n n n n n n n

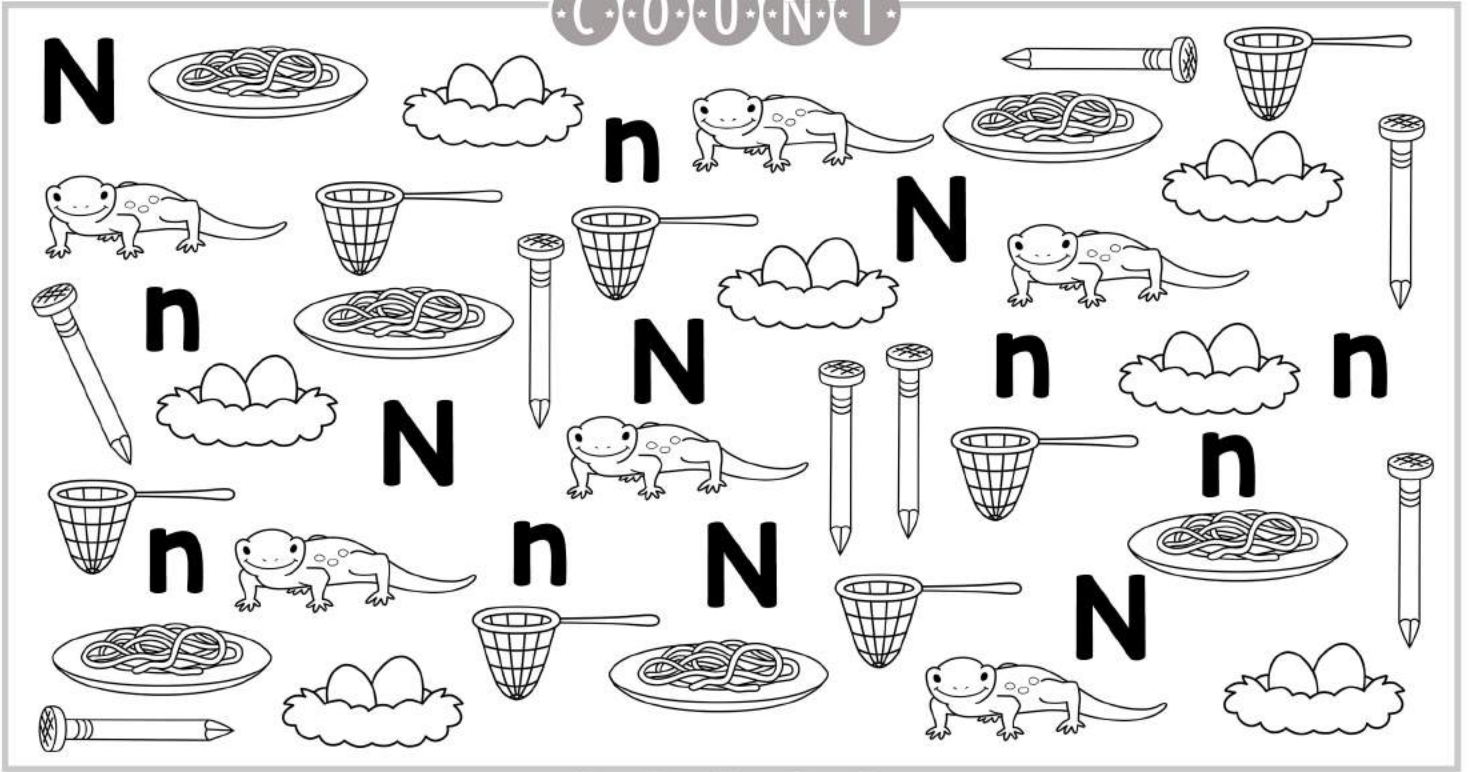

C O U N T



G R A P H

N	n					

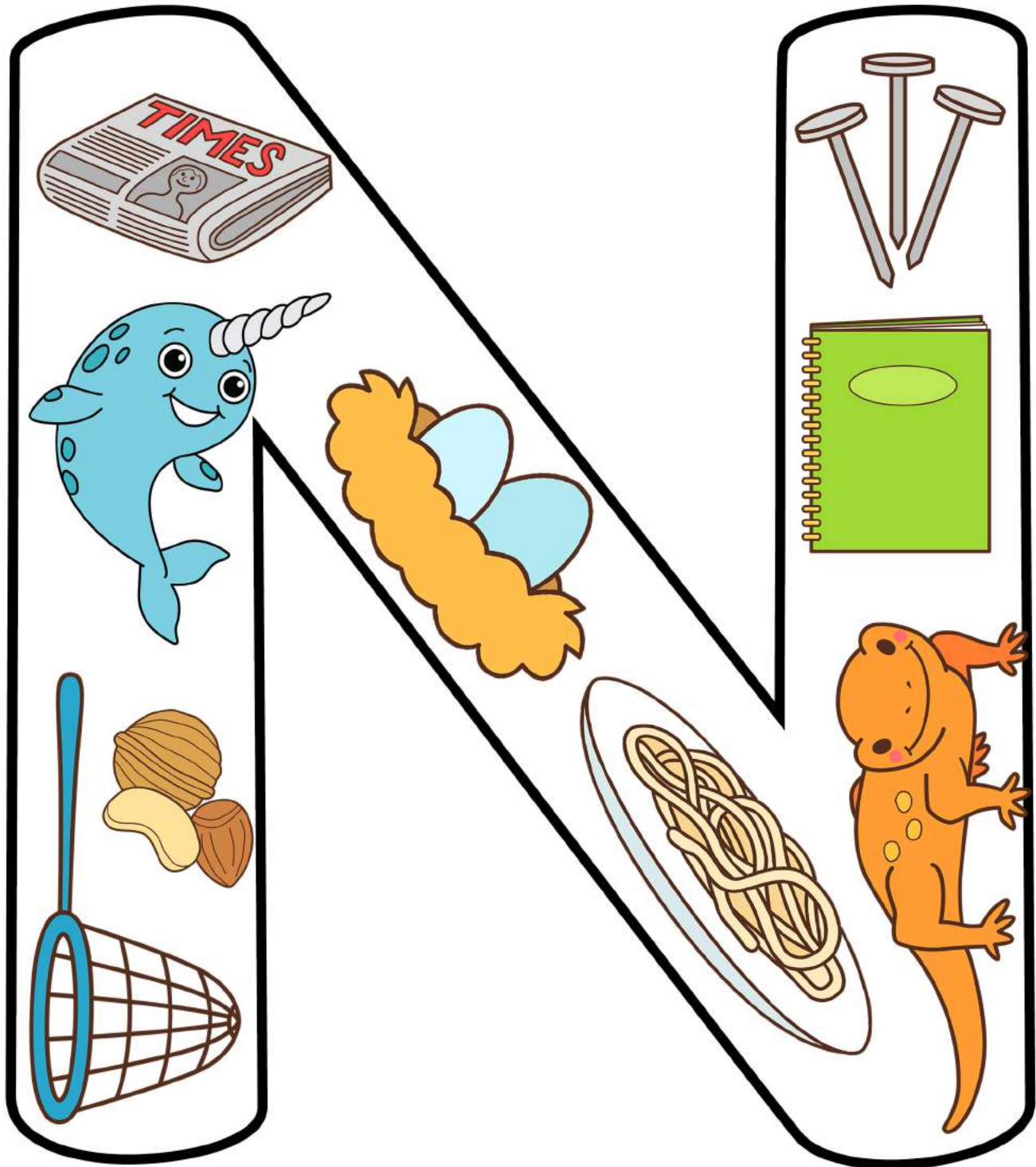

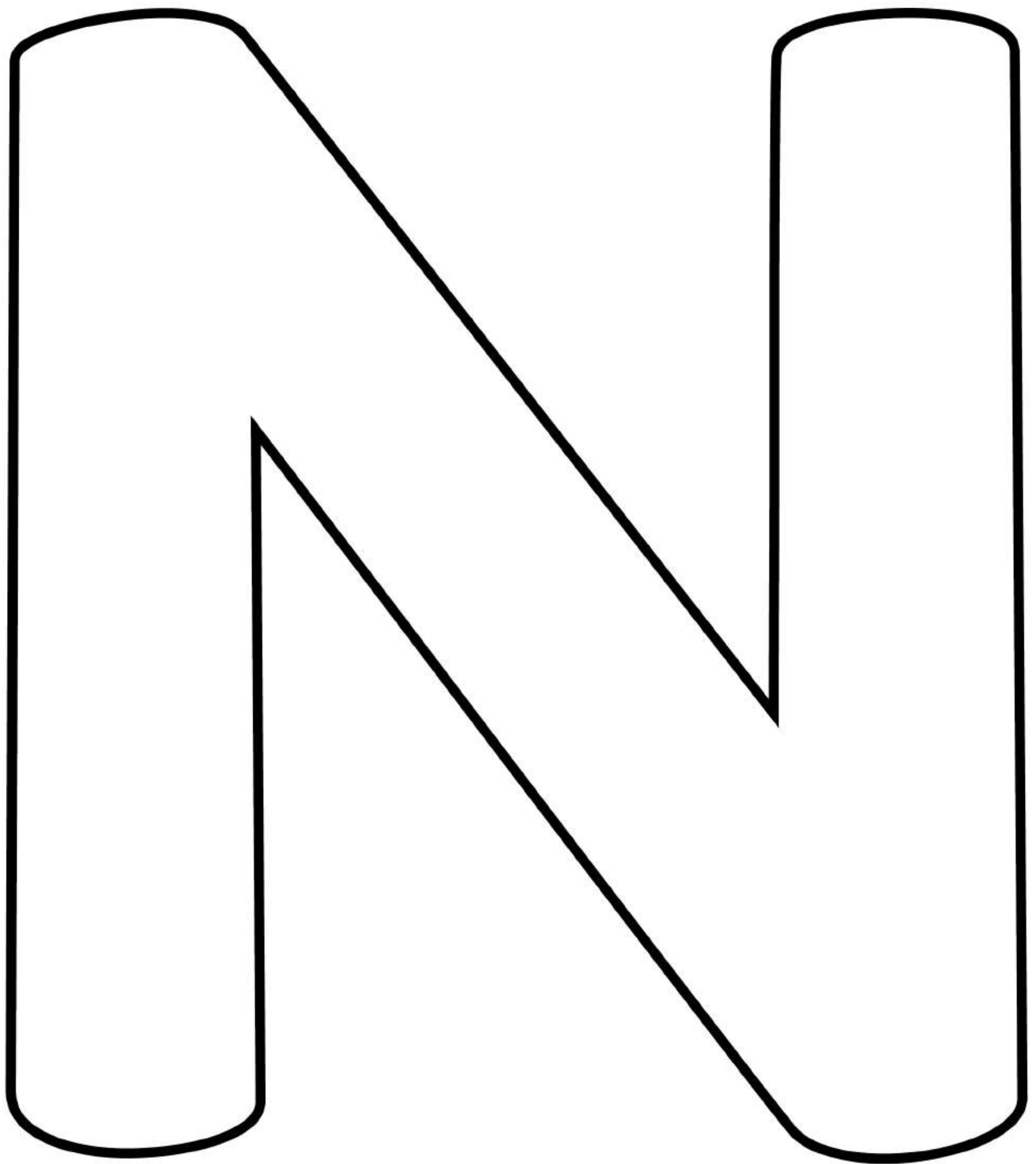

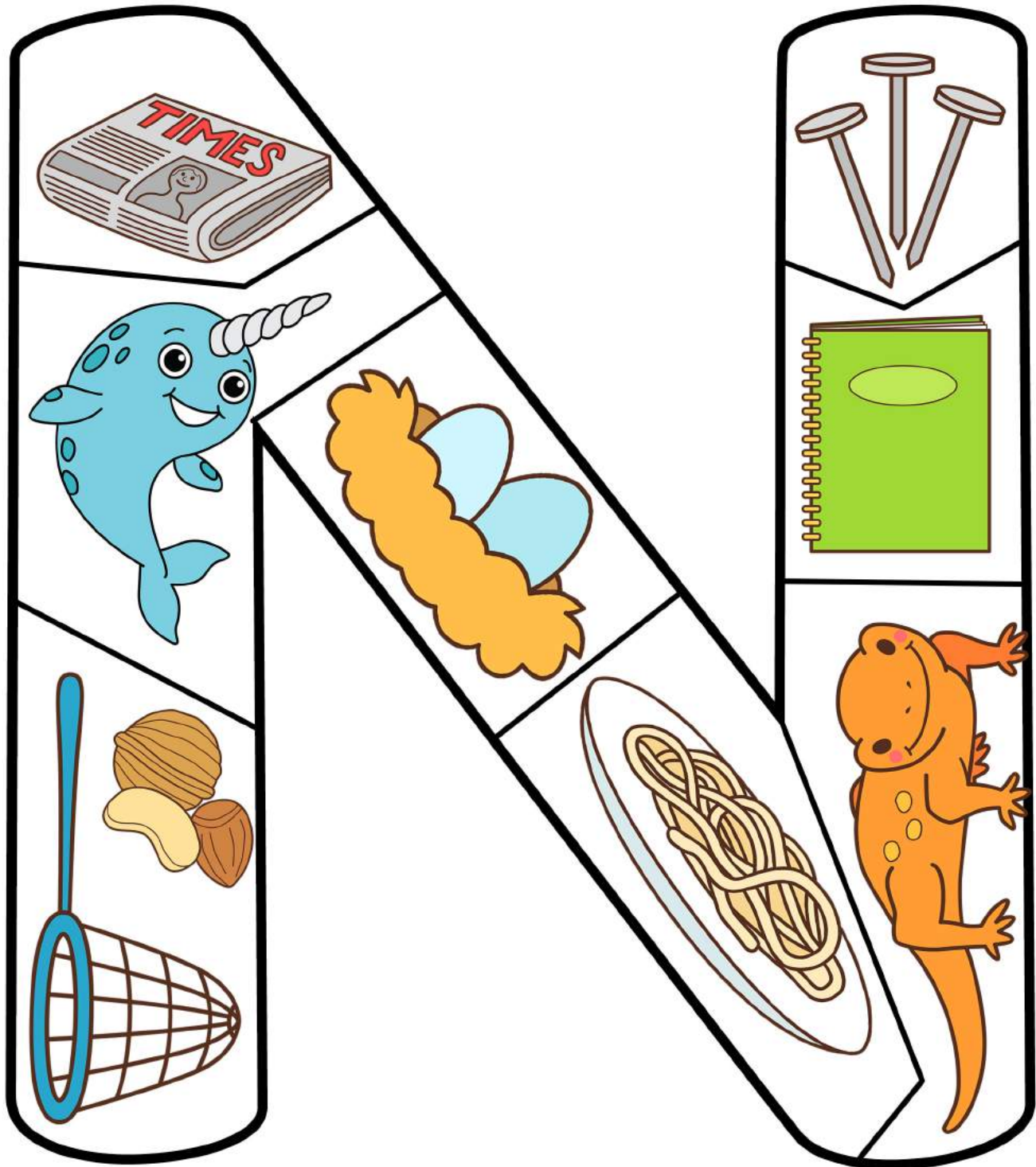

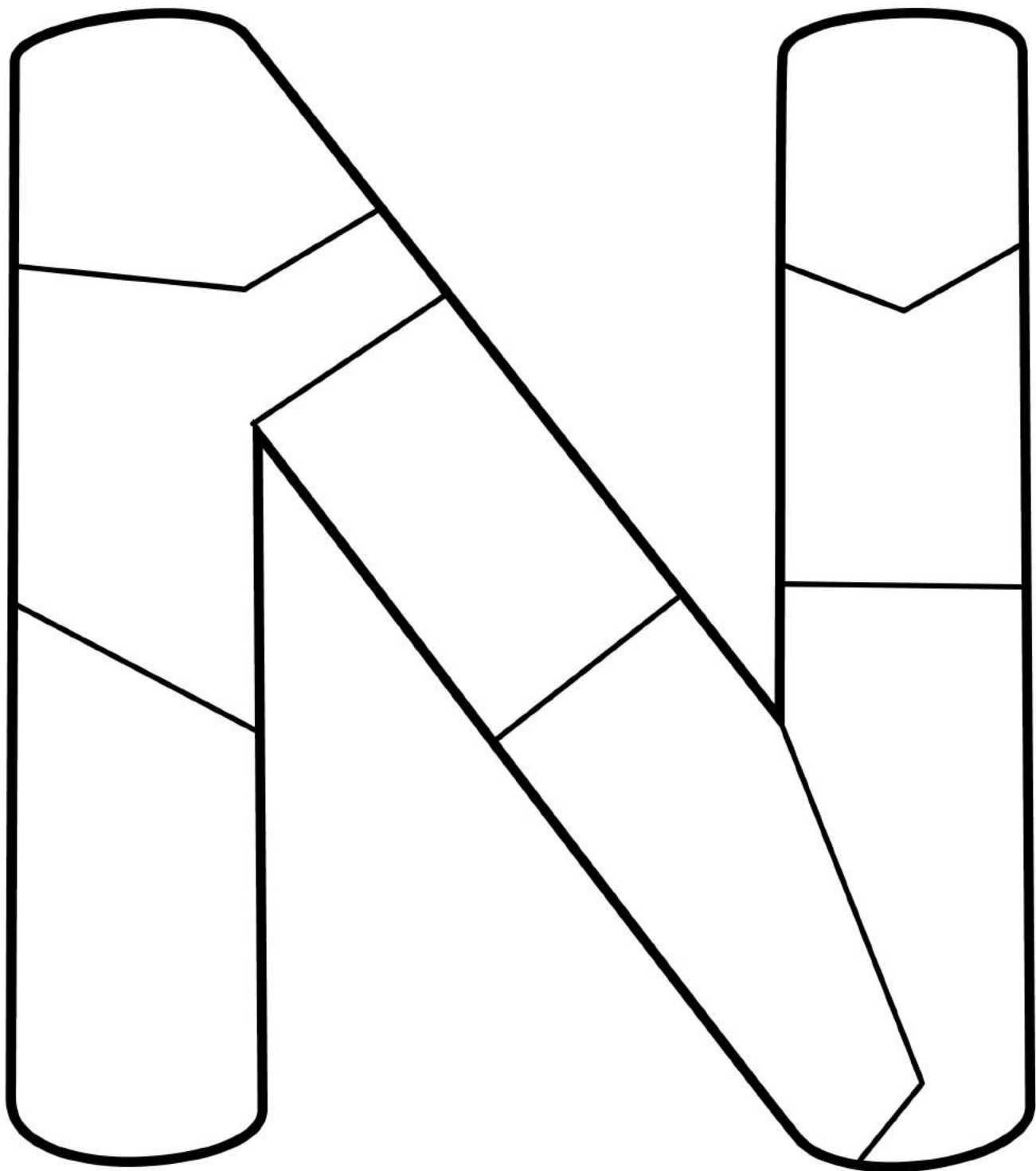

1. Write

2. Cut Out 

NAME : _____

N N

N N

n n

n n

N n

A B C Q U I L T

3. Color

4. Cut out 

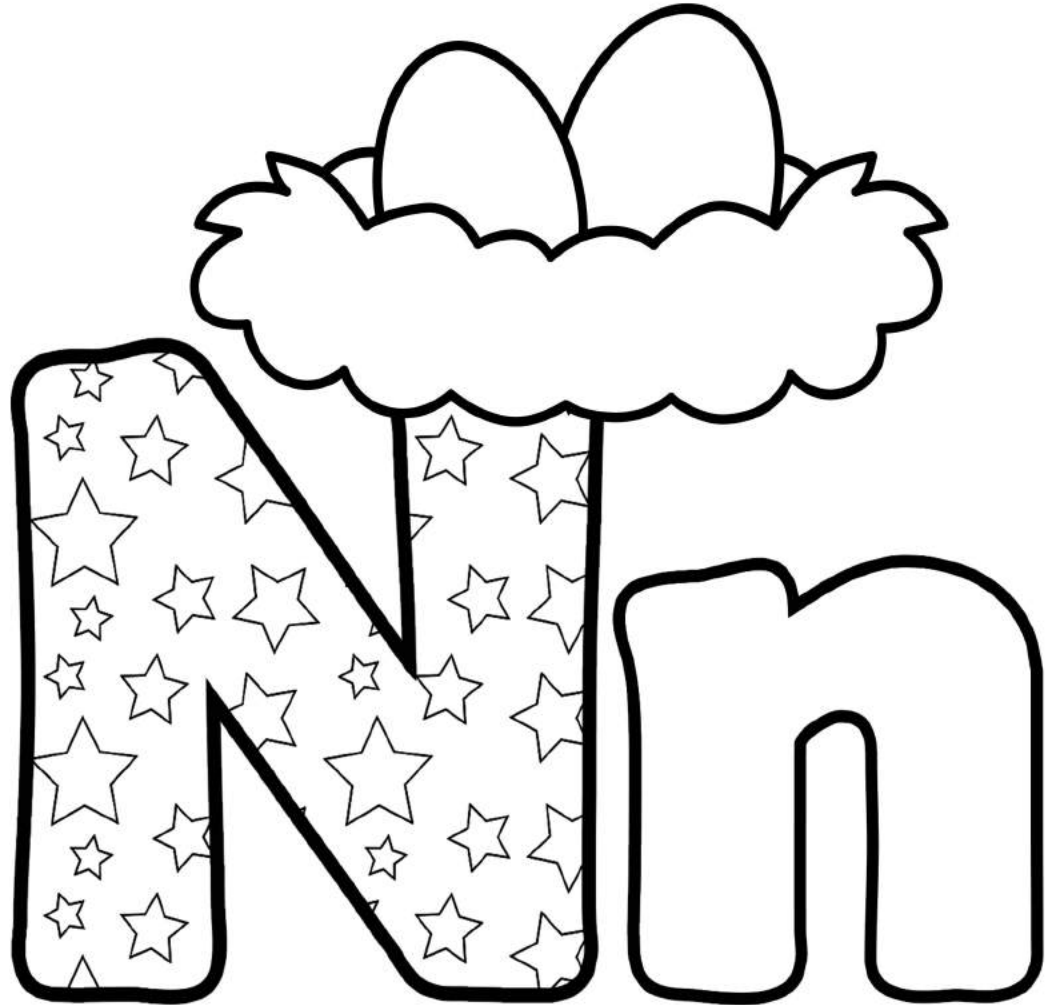

NAME : _____

NAME : _____

Nn

Write and read words that begin with letter n.



net net net



nest nest



nuts nuts



nose nose



nails nails



note note

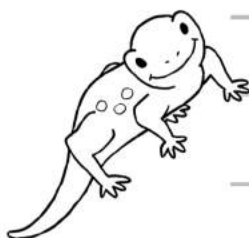

newt newt

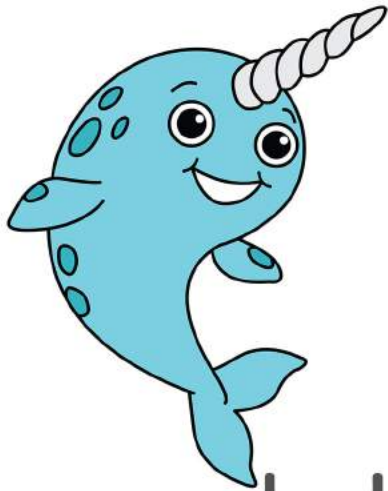

narwhal

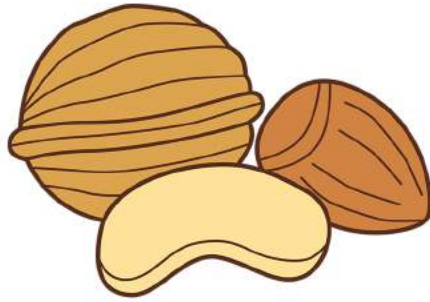

nuts

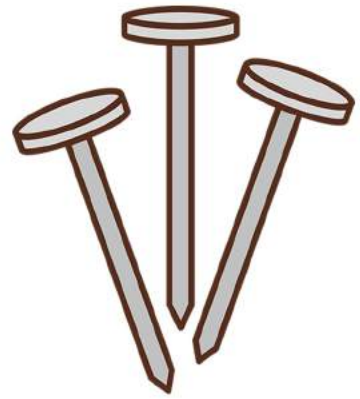

nails

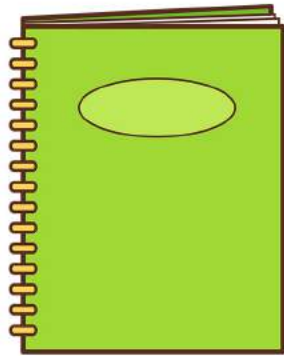

notebook

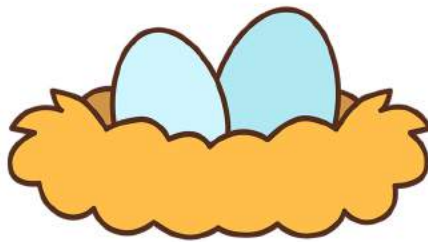

nest

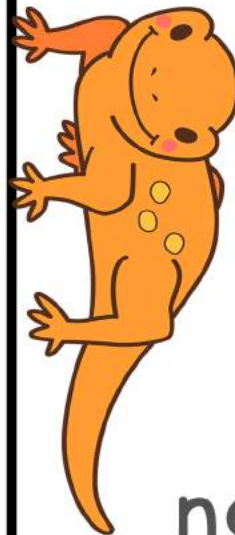

newt



newspaper

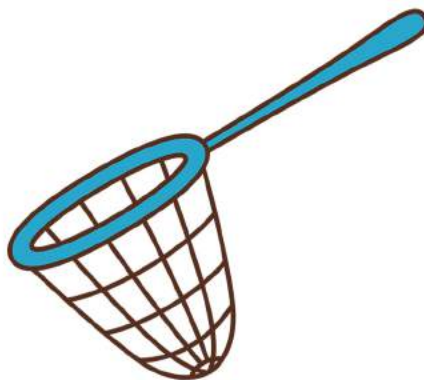

net



necklace

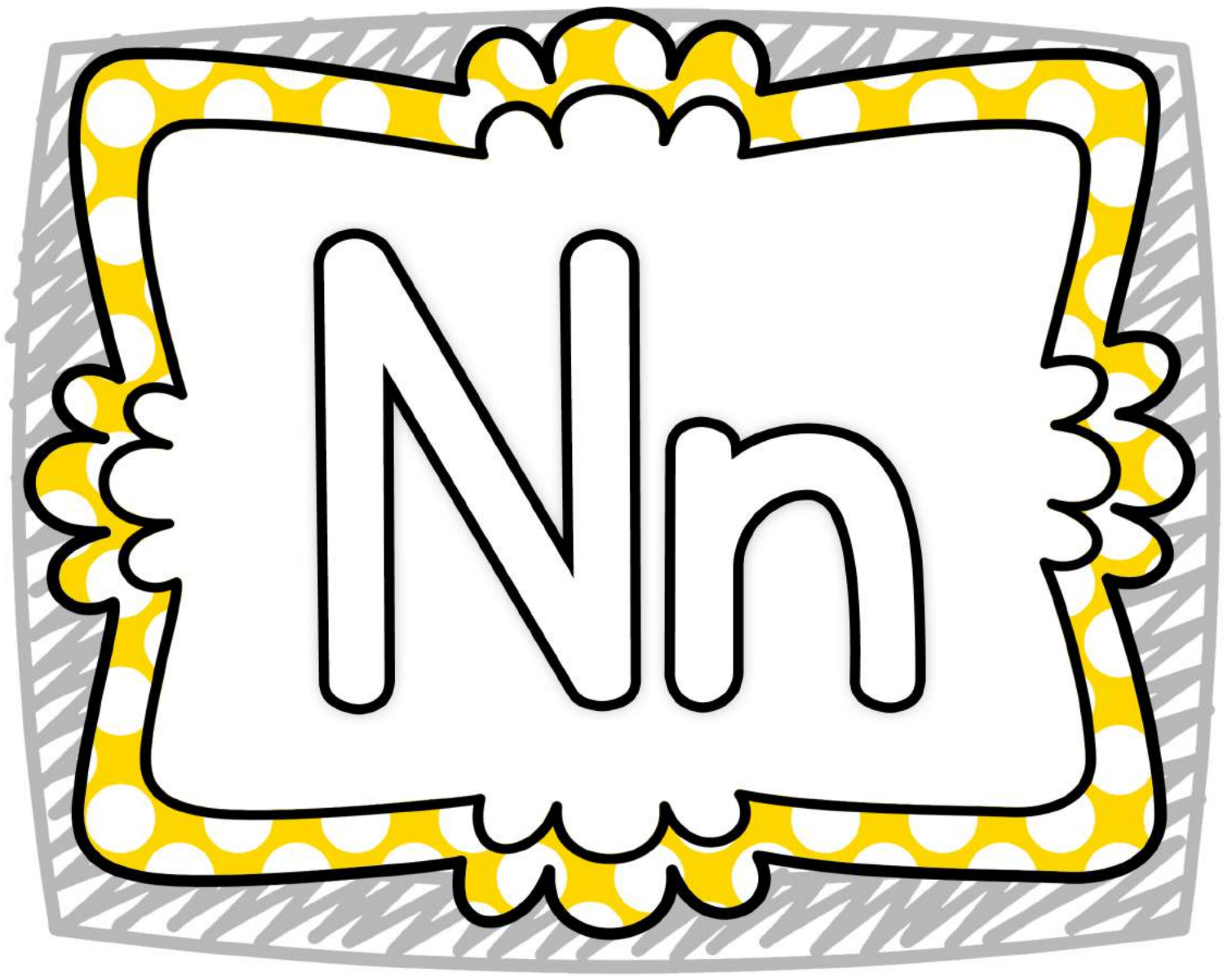

LETTER N



4 IN A ROW

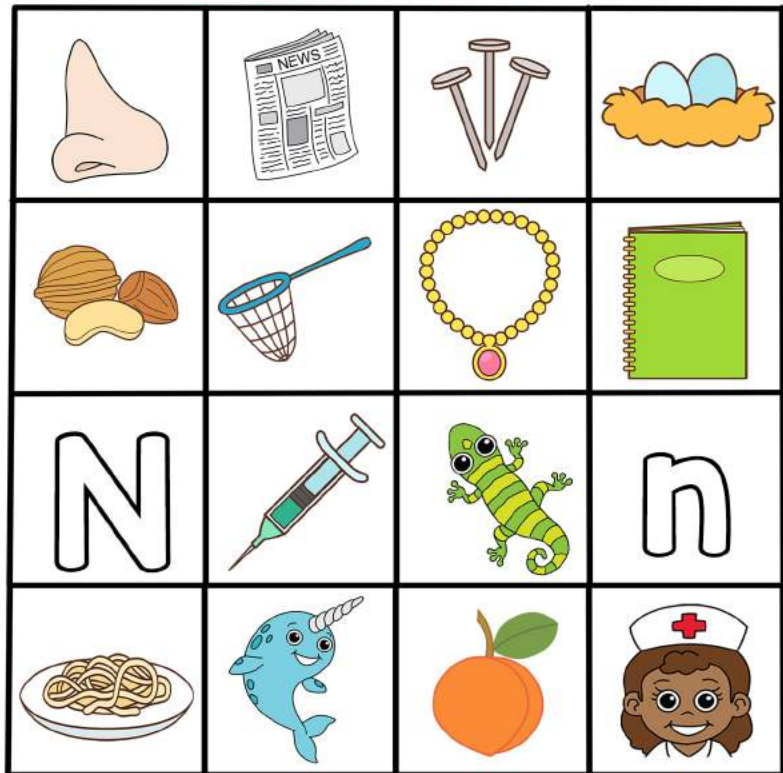

LETTER N



4 IN A ROW

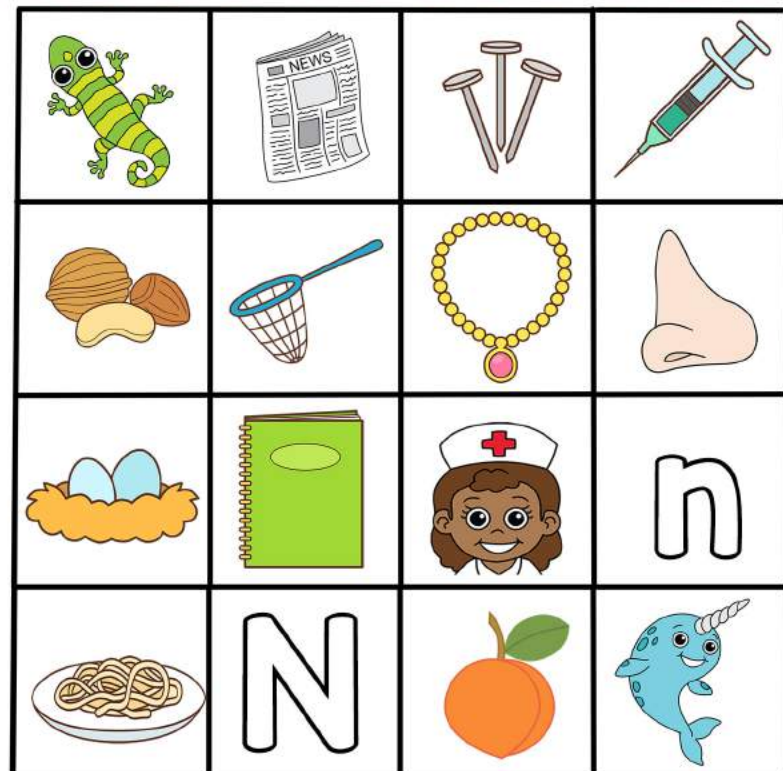

LETTER N



4 IN A ROW

LETTER N



4 IN A ROW

I C A N W R I T E

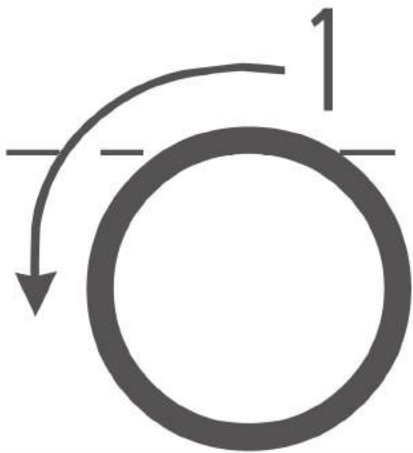
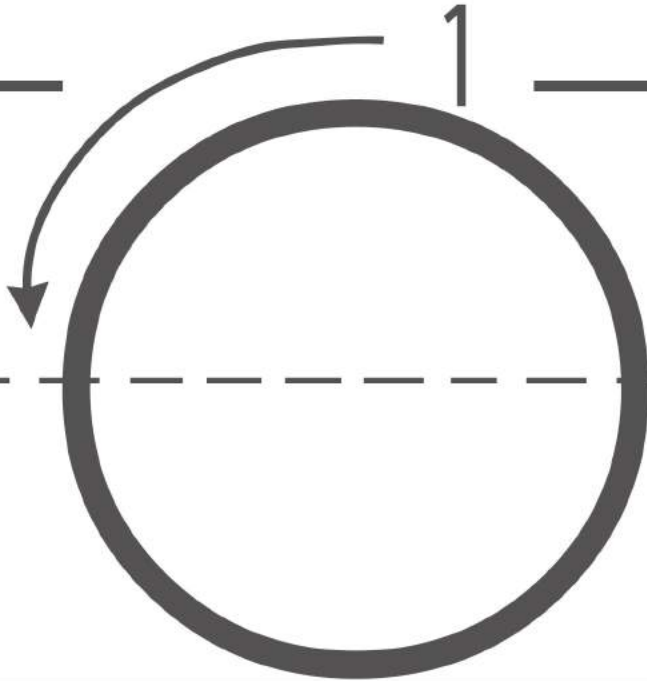

Circle Down
and Around

Circle Down
and Around

Octopus

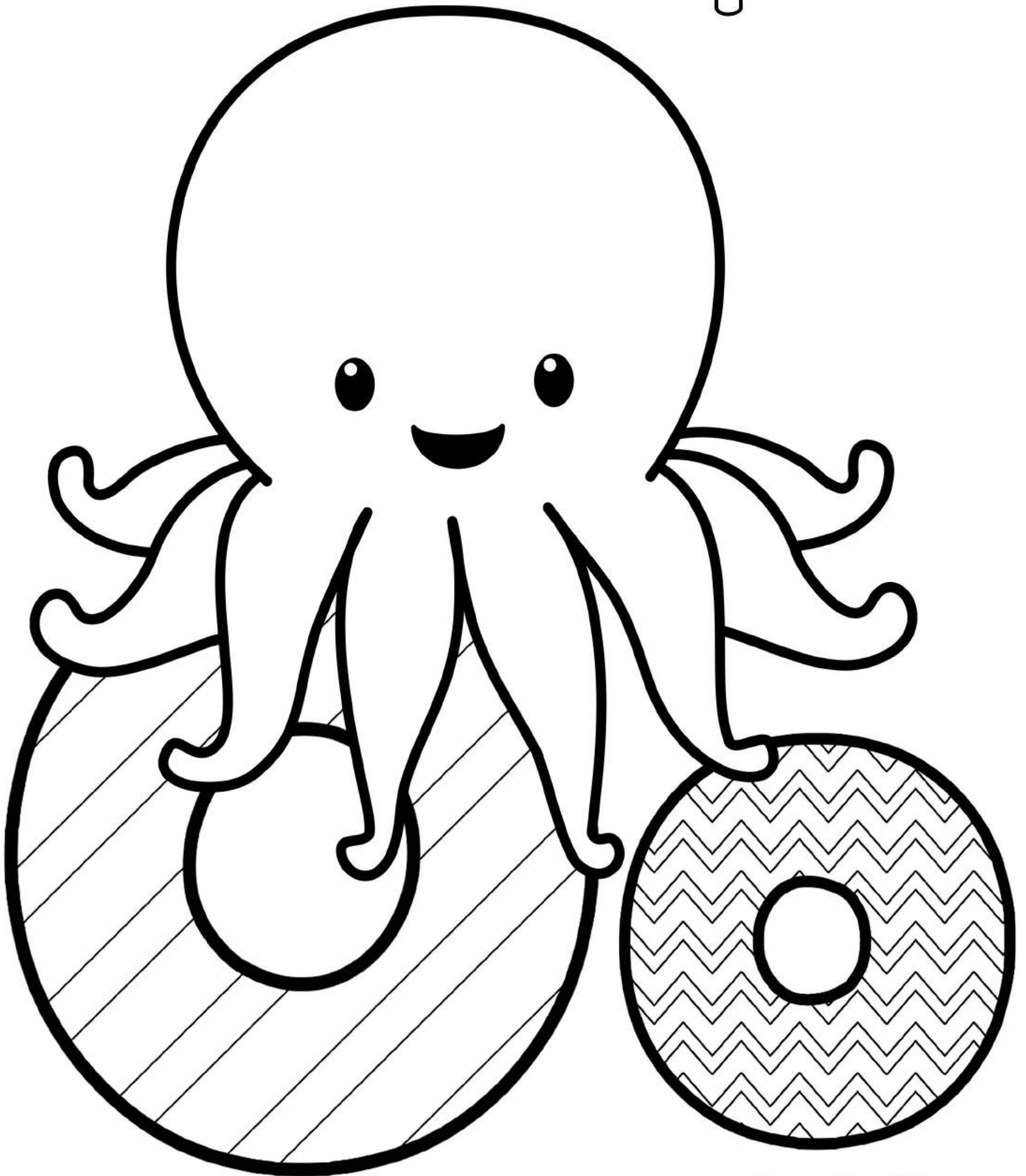

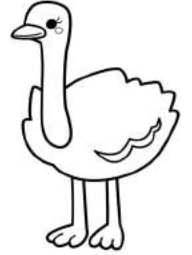
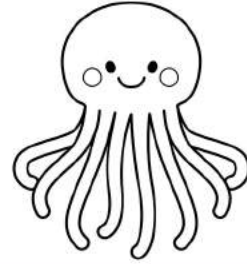
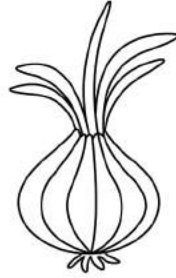
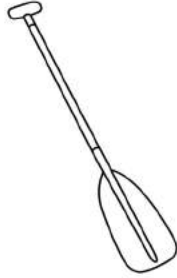
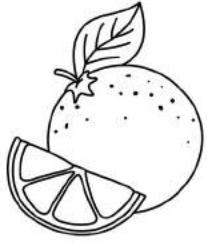
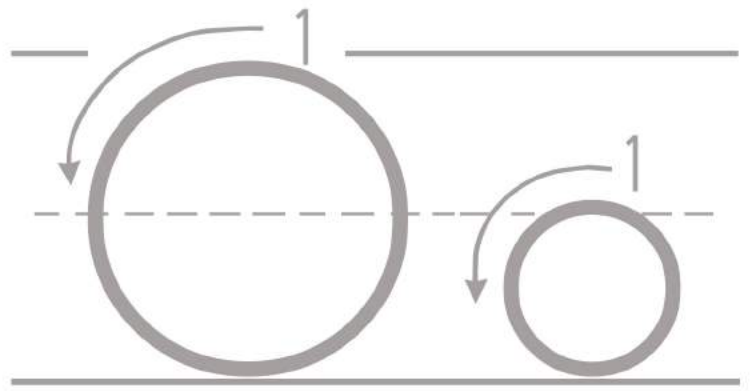
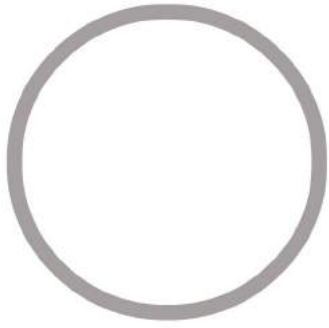

orange

oar

owl

onion

octopus

ostrich

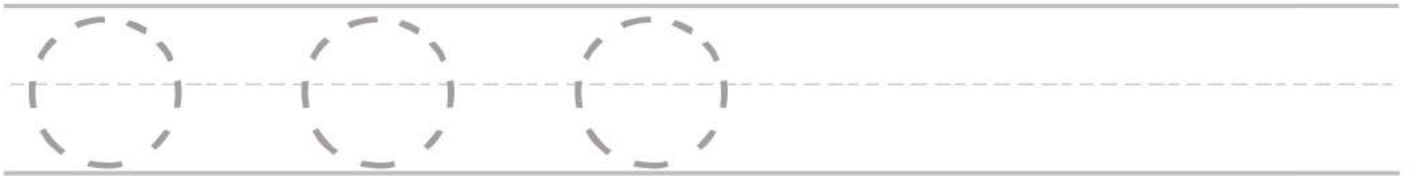
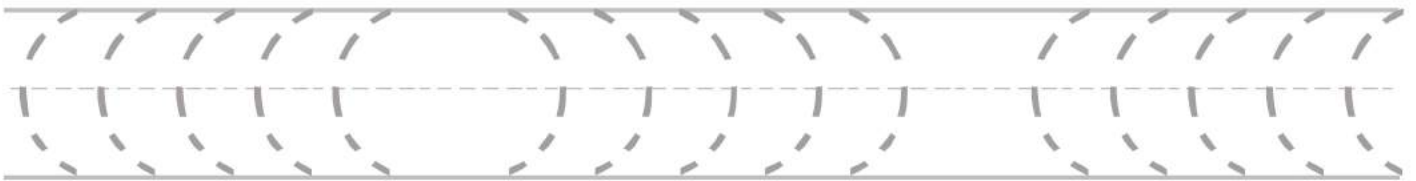

Measure the height and width of the oval:

Give the octopus eight legs:

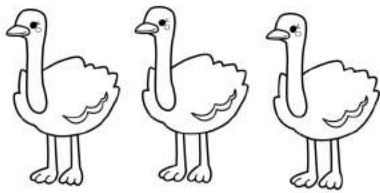
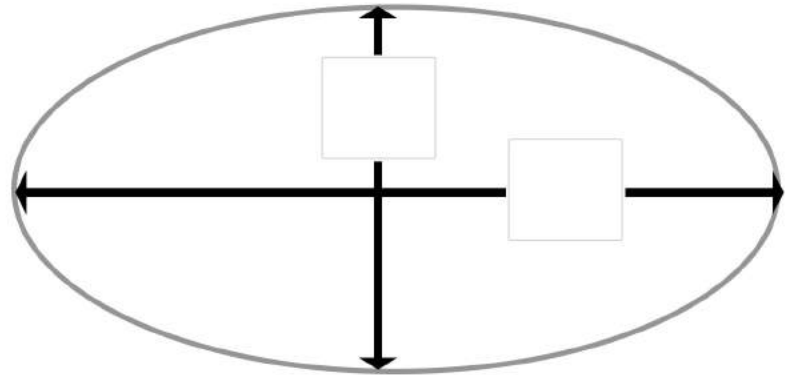

Subtract

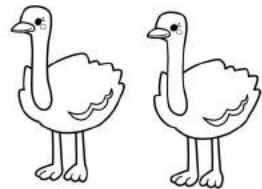

$$= \square$$

Color every other stripe on the oval:

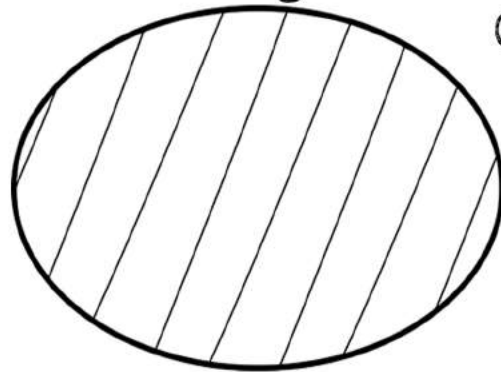

$$3 - 1 = \square$$

$$3 - 2 = \square$$

3		3
-	1	-
—		—
\square		\square

Draw an oval around the owl.
 Draw three "O's" inside the oval.
 Draw five "o's" outside the oval.
 Circle the owl's beak.



Skip Count by 2's

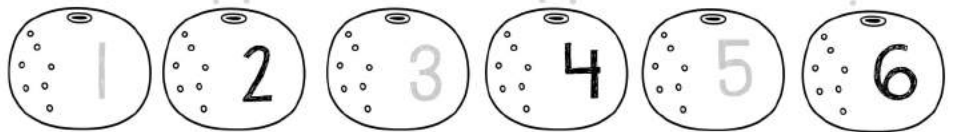

Draw: $3 - 1 = 2$
 $+$ $=$



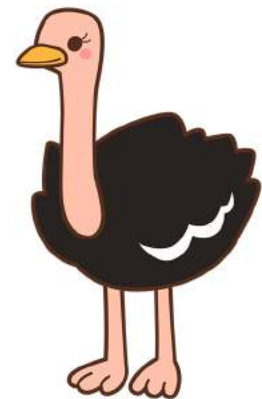
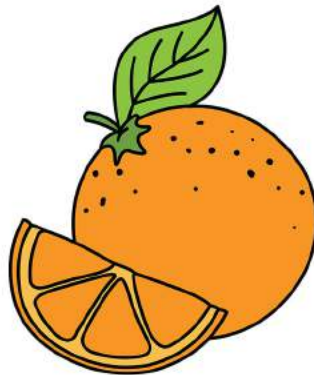
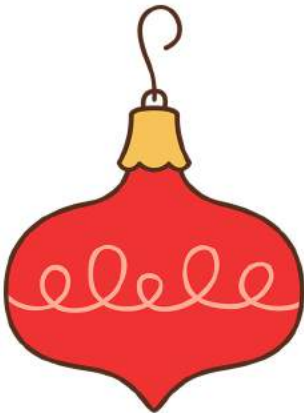
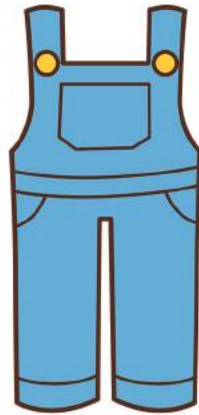
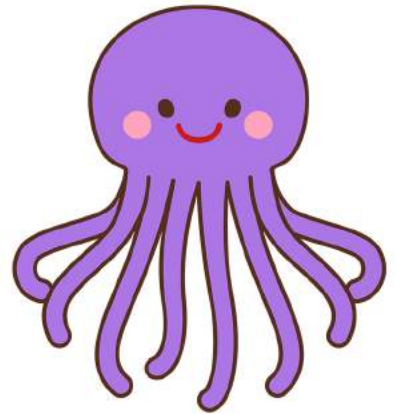
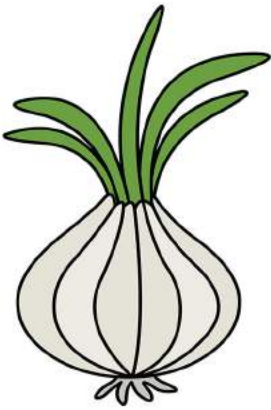
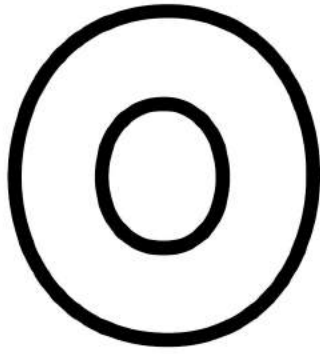
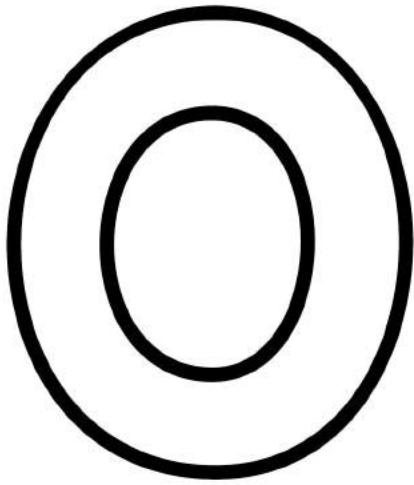

I CAN COLOR

words with:

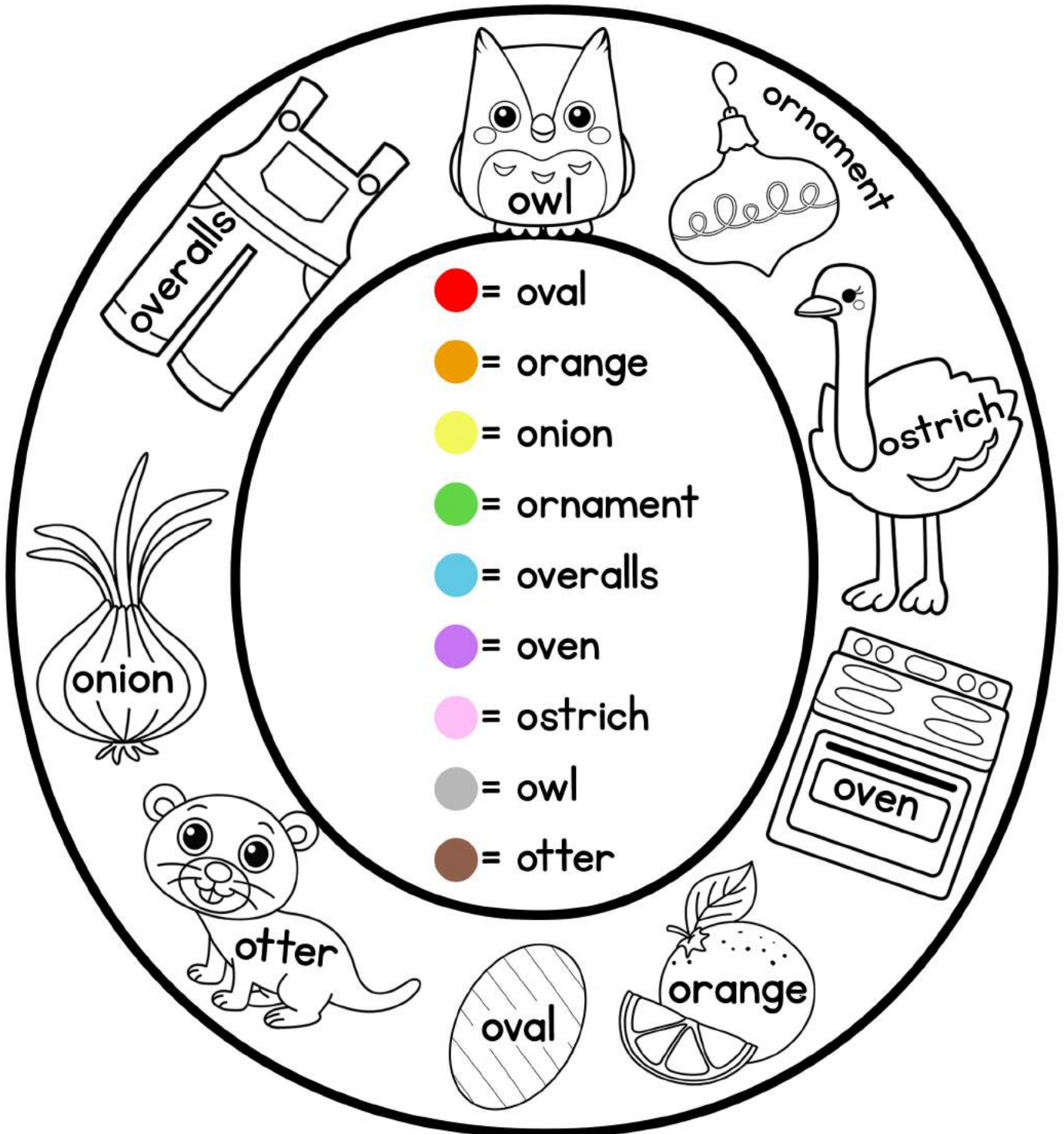

NAME : _____

Oo

Write and read words that begin with letter o.



owl owl owl

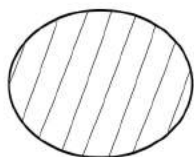

oval oval



car car car

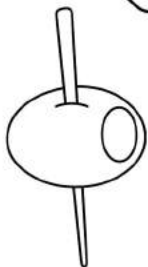

olive olive



oven oven

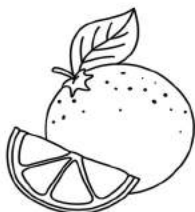

orange



onion onion

NAME : _____

Oo

Write and read words that begin with letter o.



owl owl owl

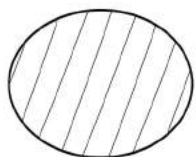

oval oval



oar oar

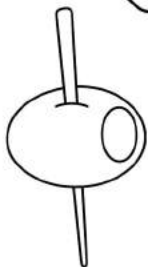

olive olive



oven oven

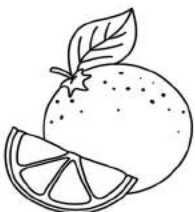

orange



onion onion

NAME : _____

RACE TO THE TOP

Use a paperclip and a pencil to complete the spinner.

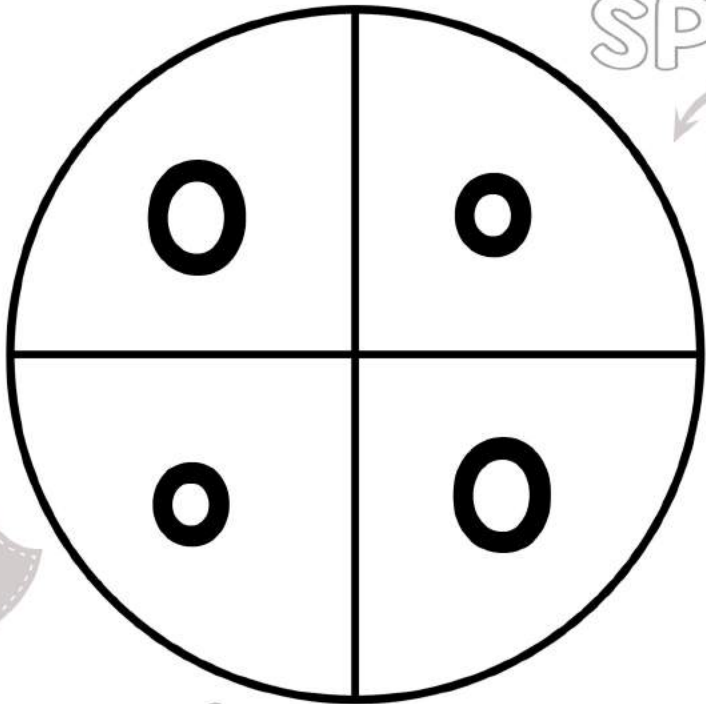

SPIN

Record

Report:

How many spins landed on O?

How many spins landed on o?

Which had more?

Write an inequality: >

How many spins total?

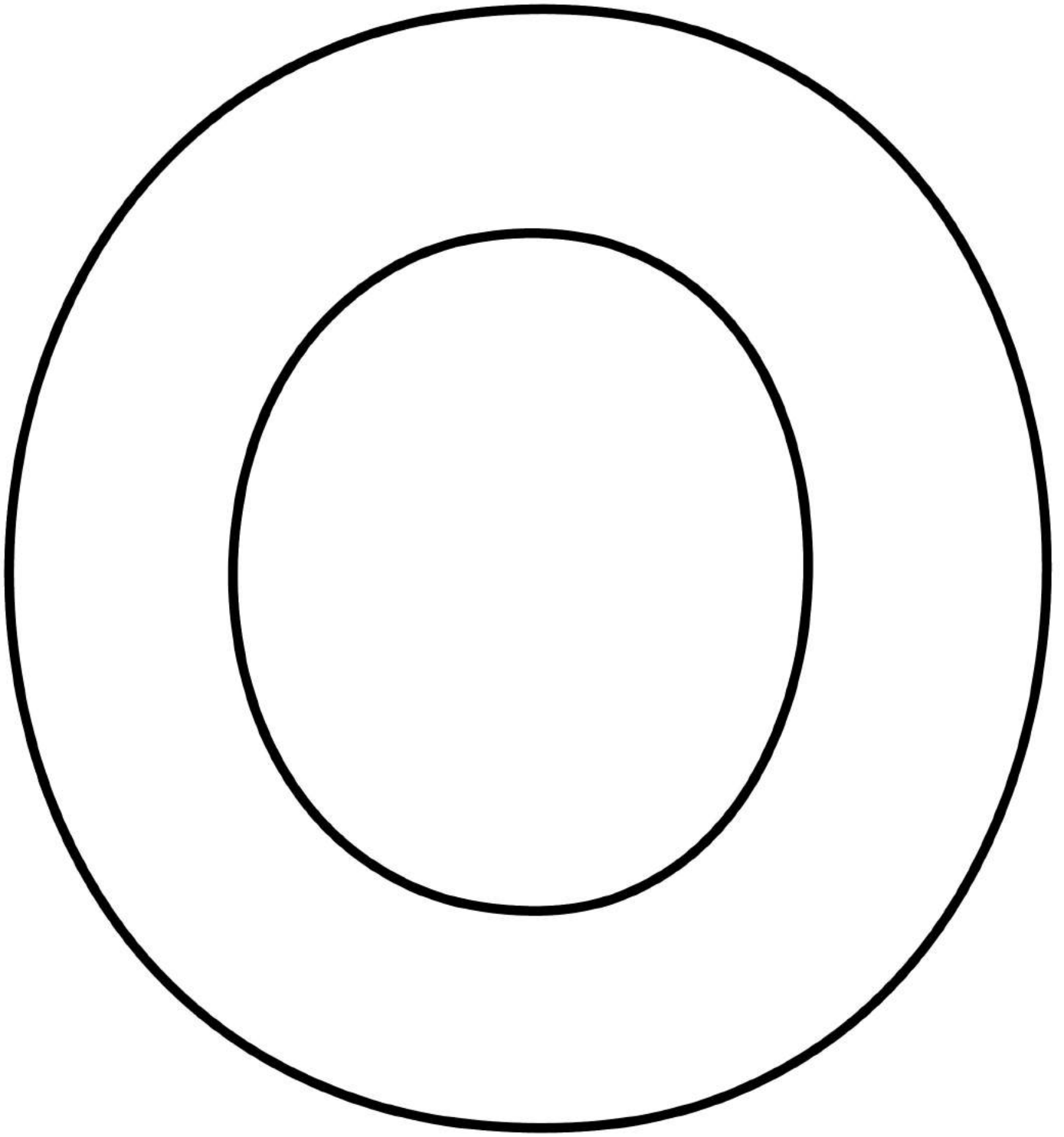

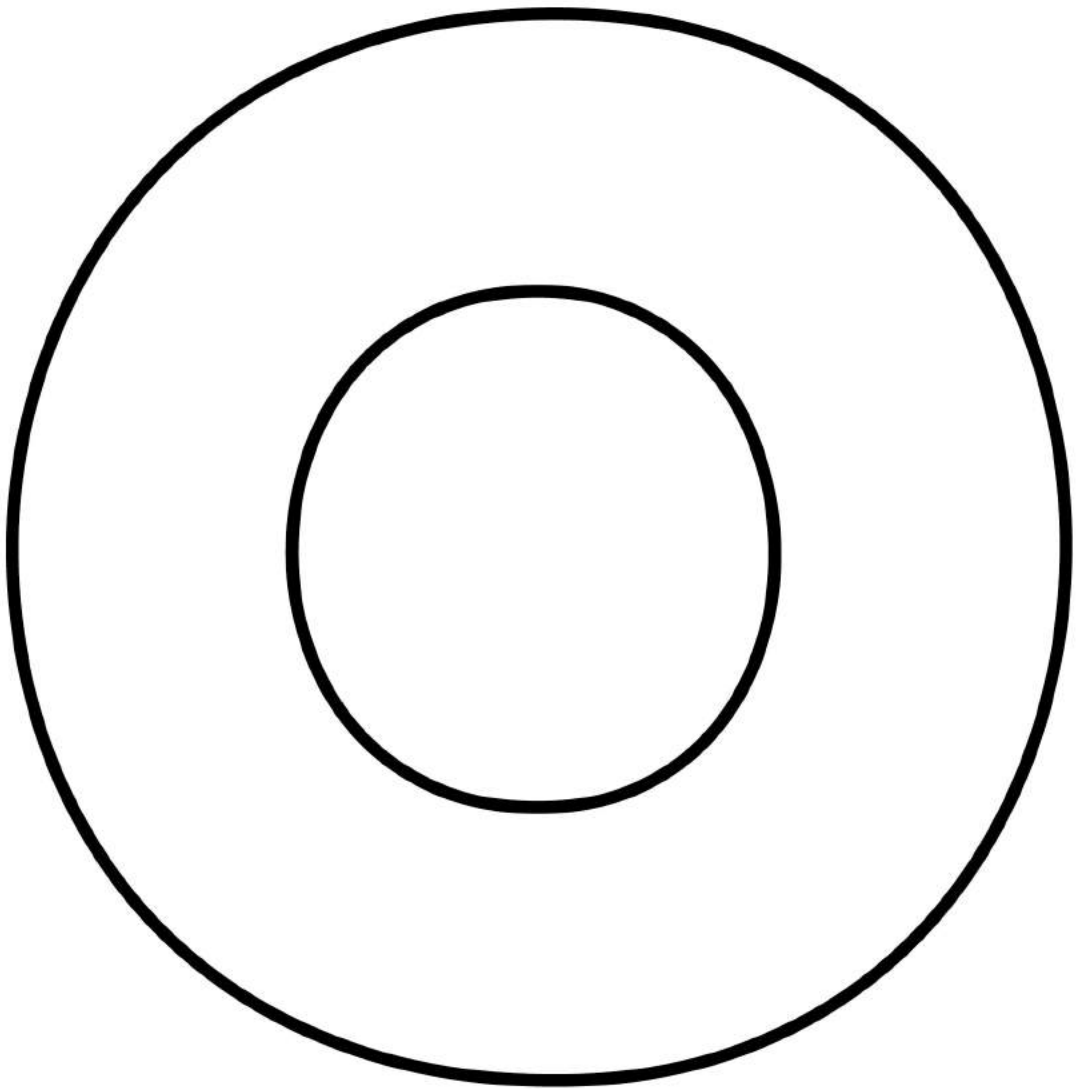

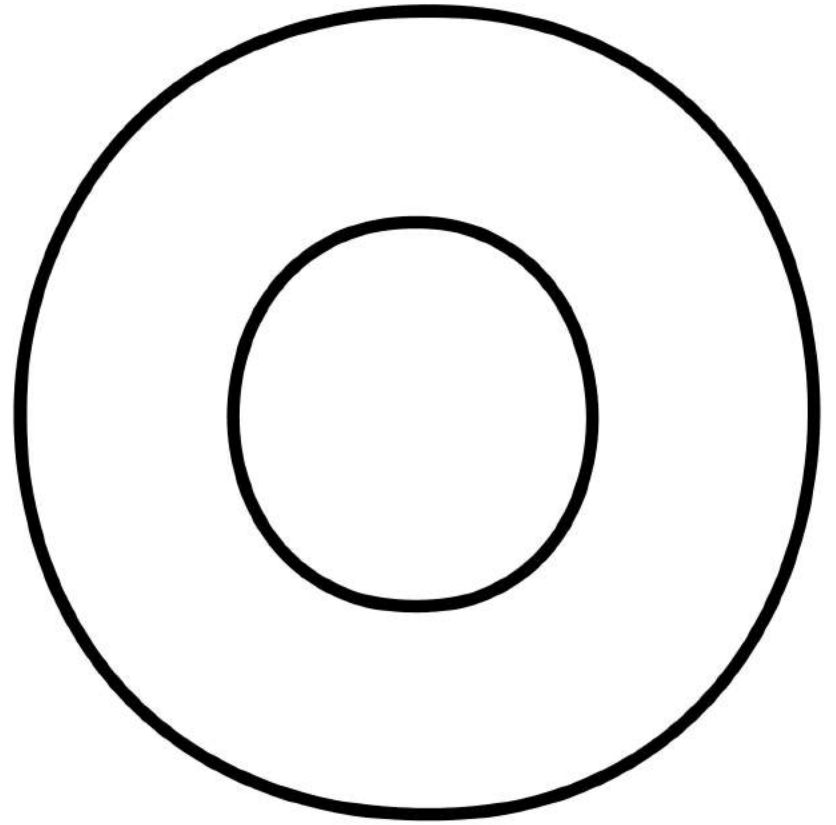
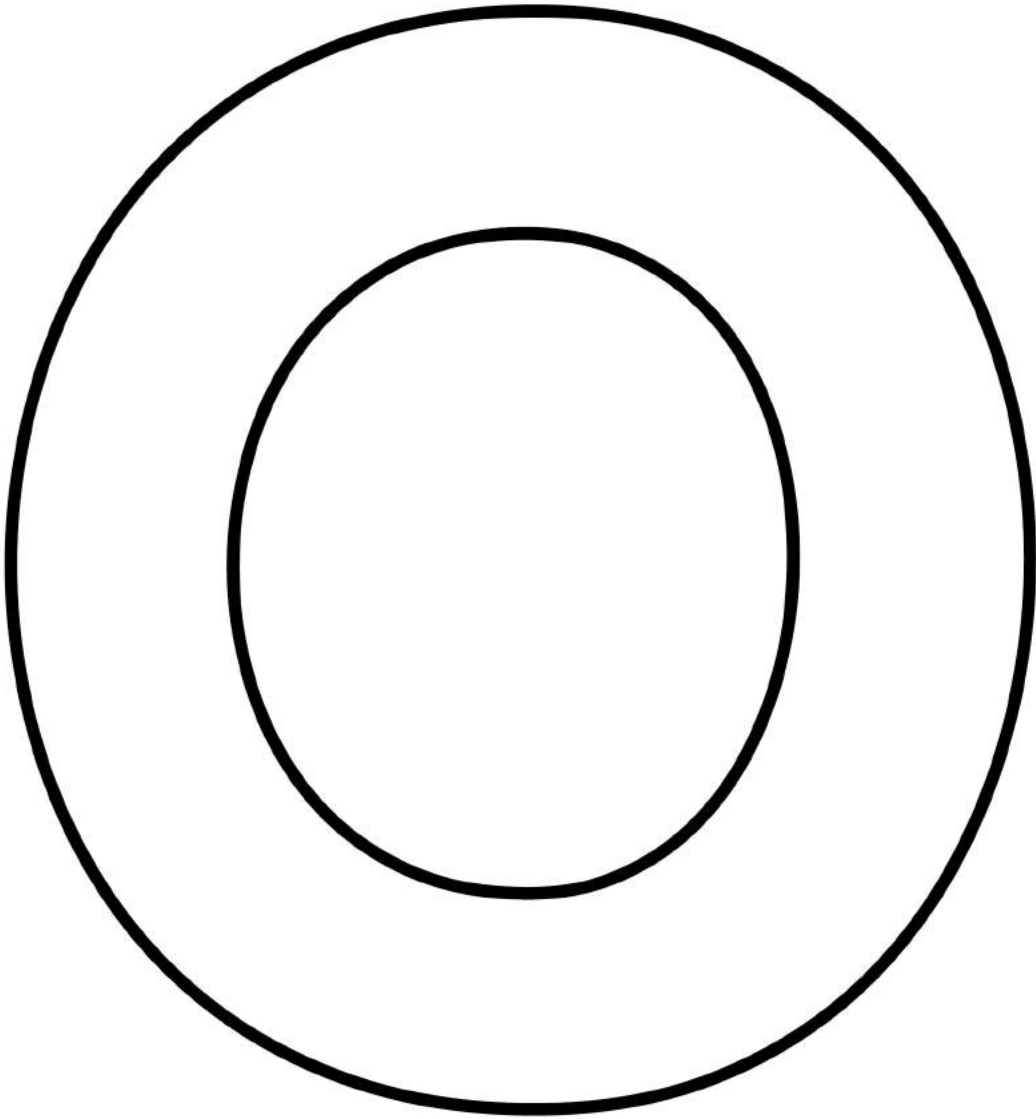

I C A N F I N D

the letter:

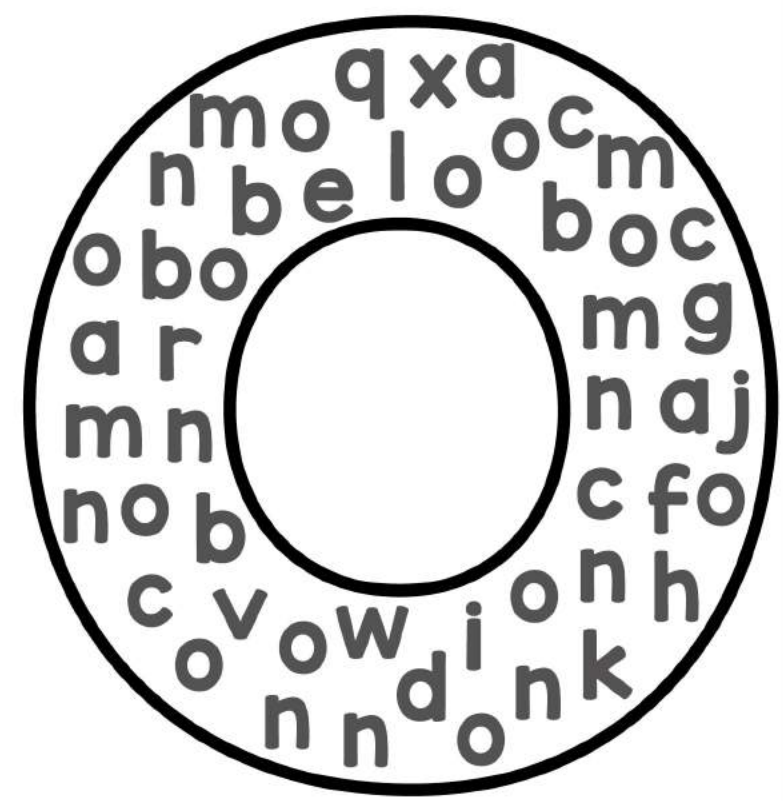
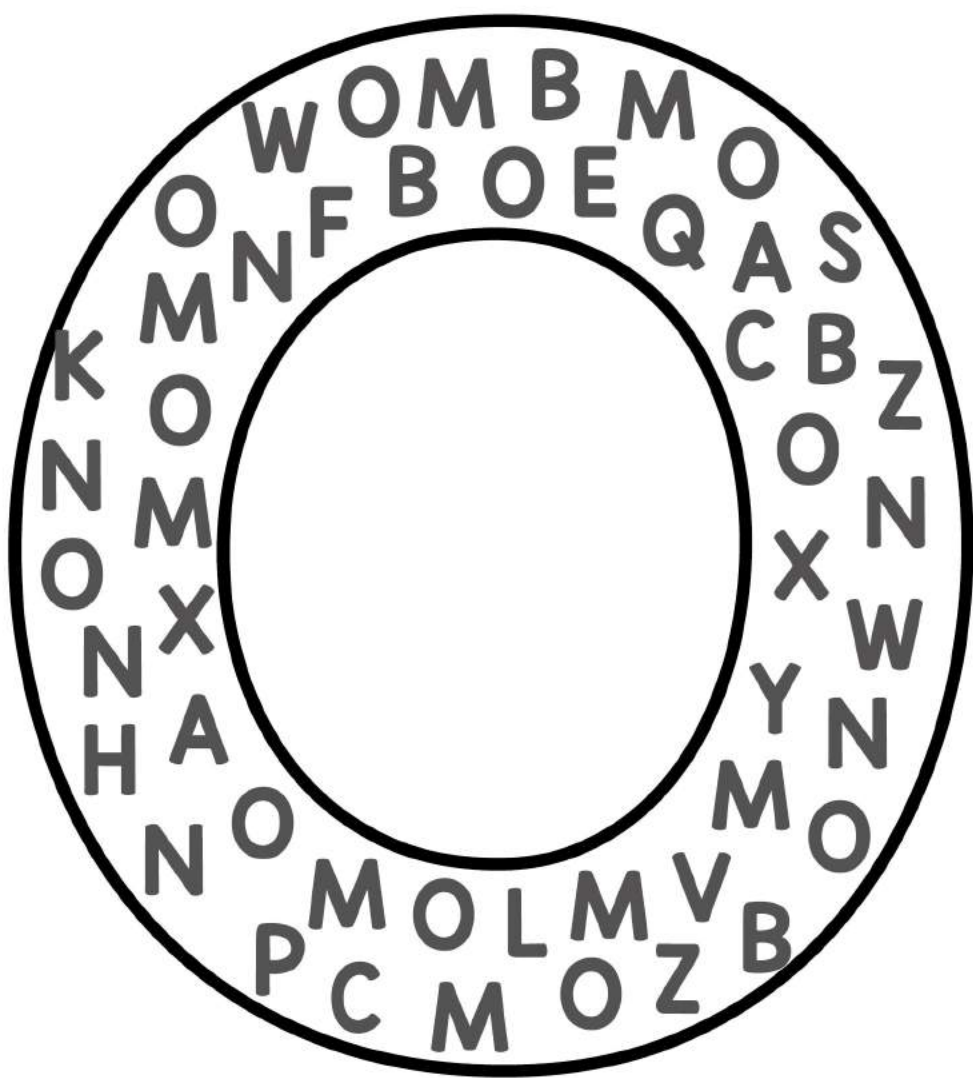

How Many?

How Many?

TRACE

NAME : _____



Color one for each row of letters you complete

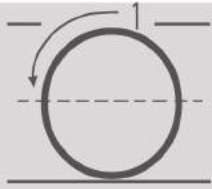

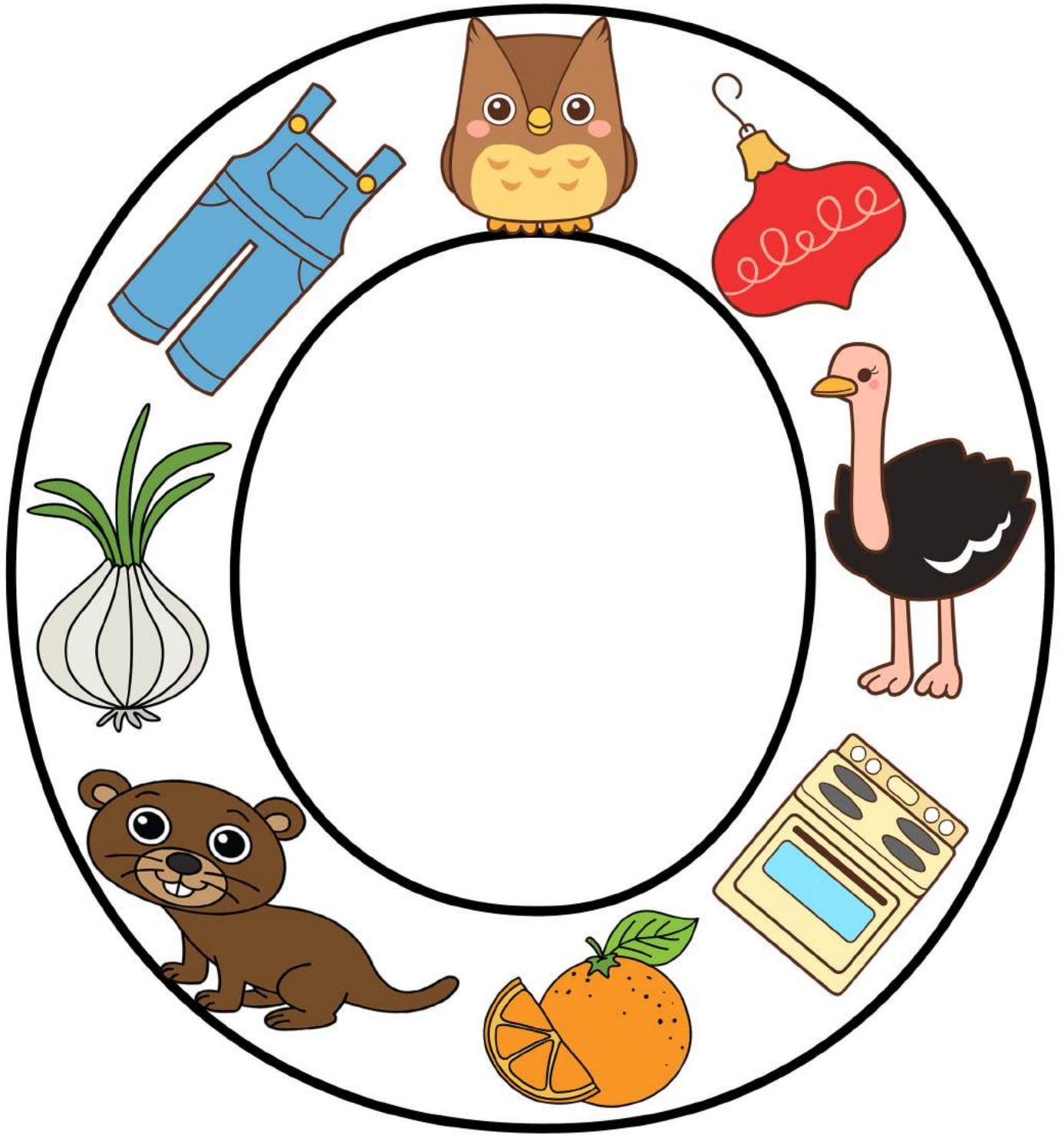

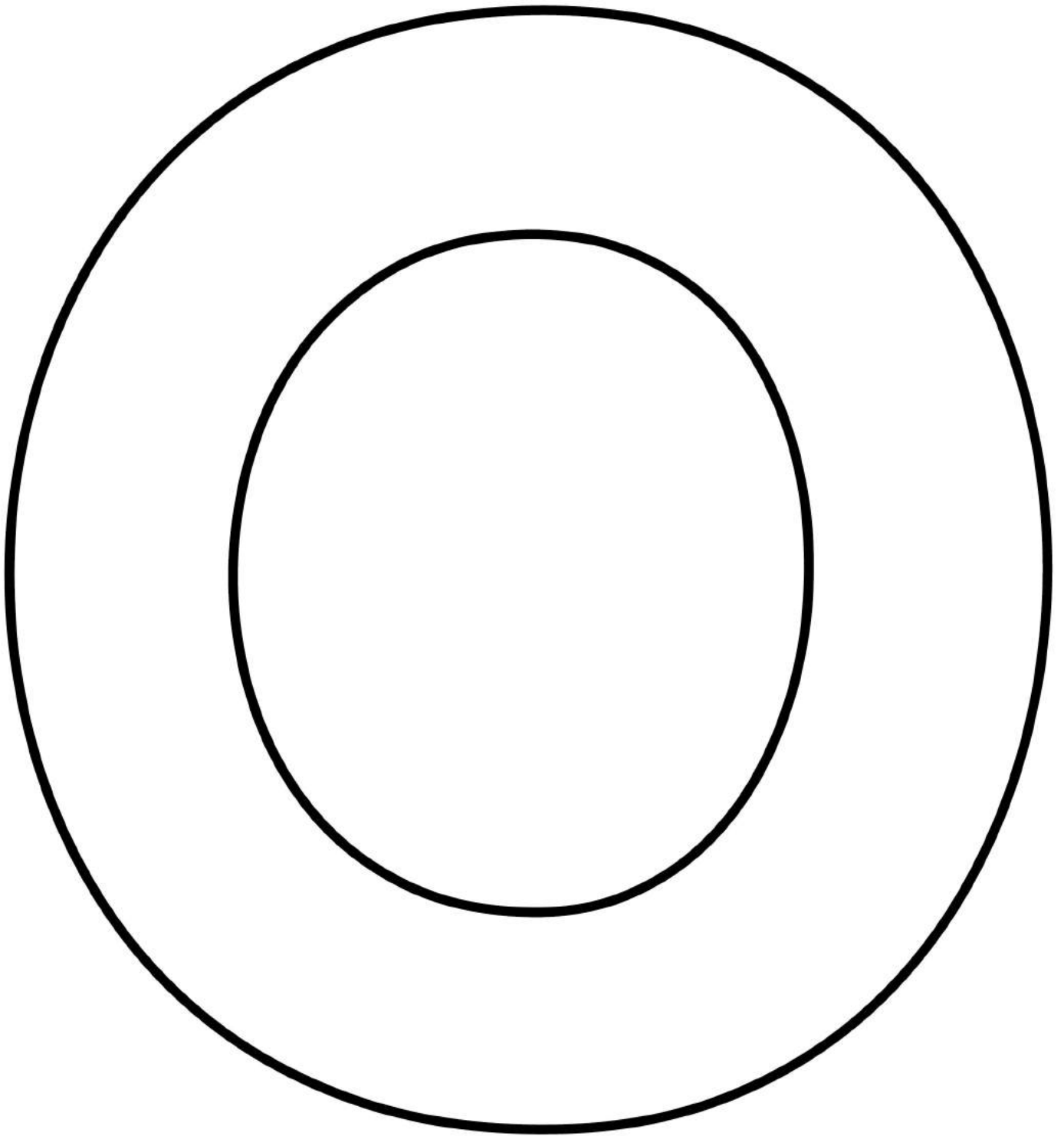

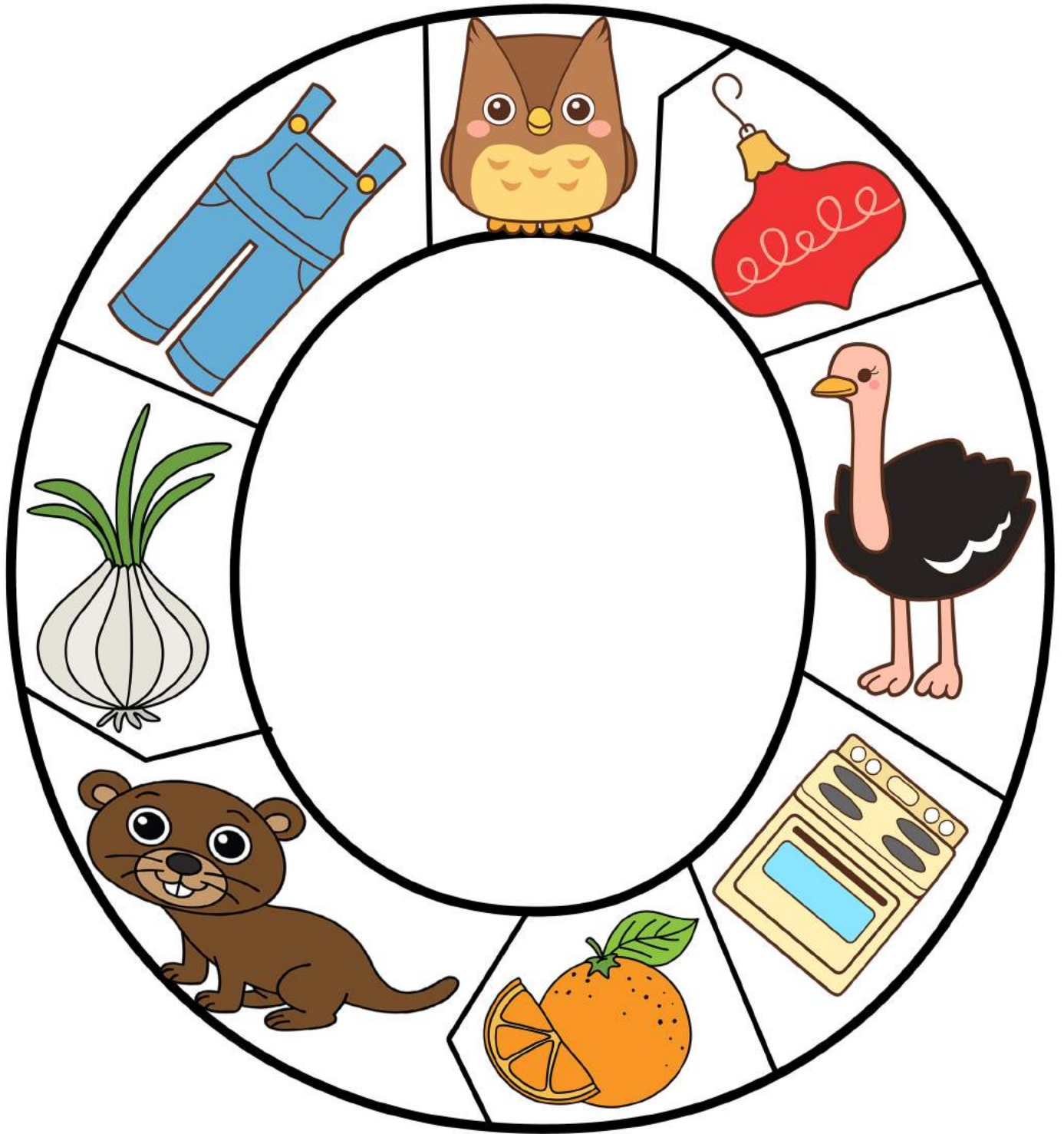

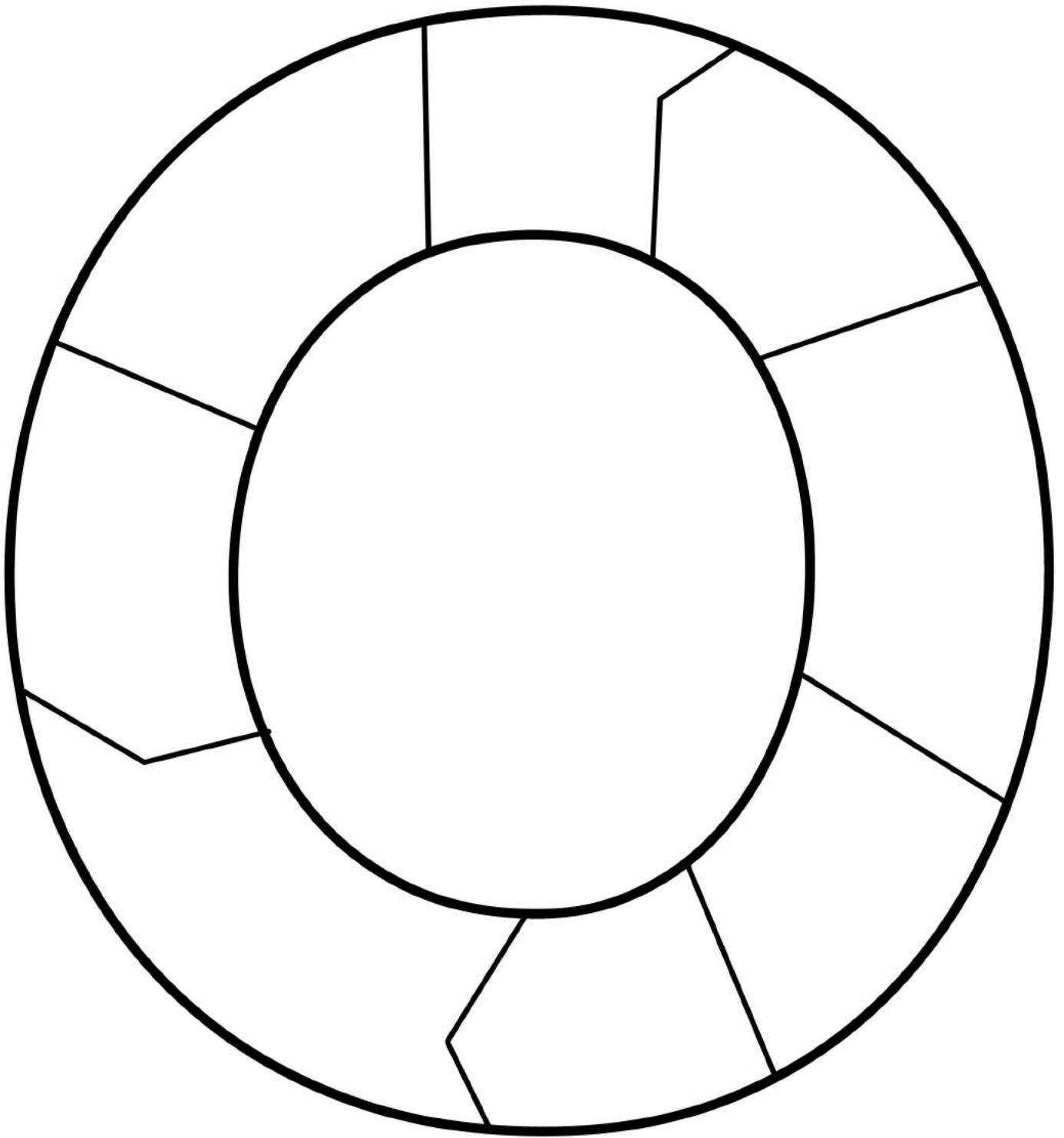

1. Write

2. Cut Out 

A B C Q U I L T

3. Color

4. Cut out 

NAME : _____

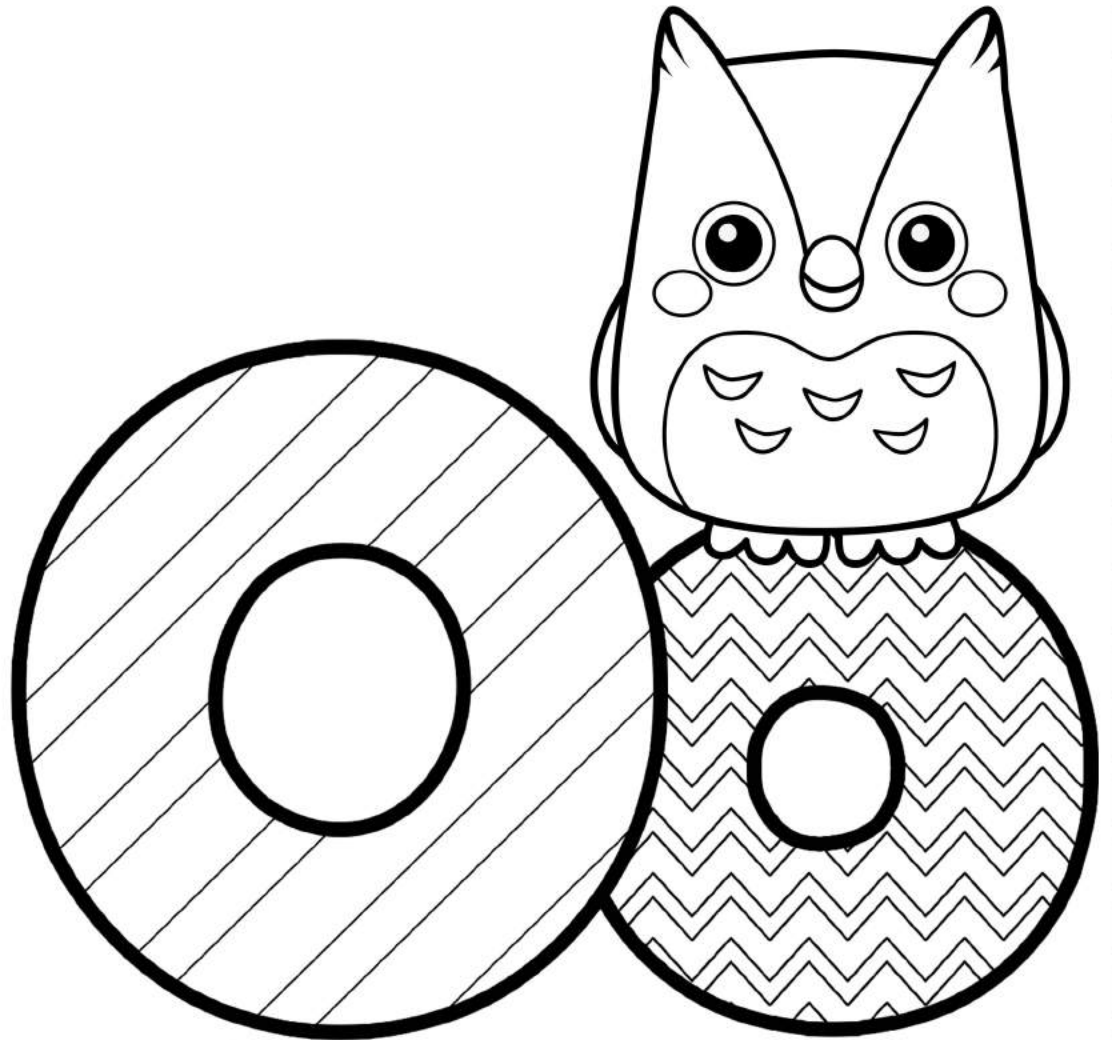
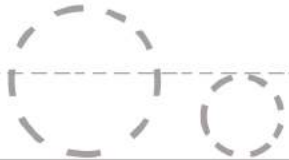
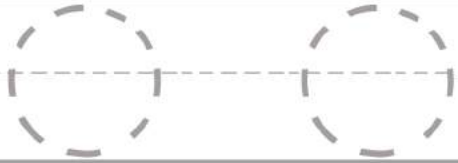
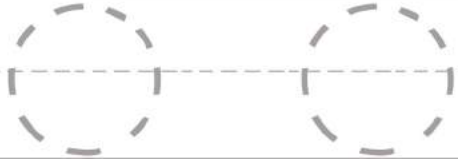

NAME : _____

NAME : _____

Oo

Write and read words that begin with letter o.



owl owl owl

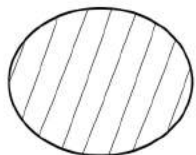

val val



ar ar ar

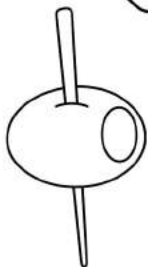

live live



oven oven

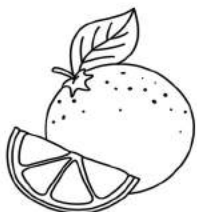

orange



onion onion



owl



oven

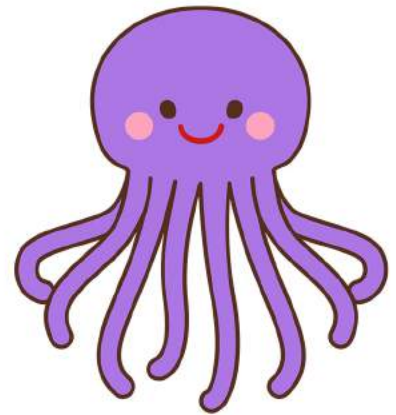

octopus

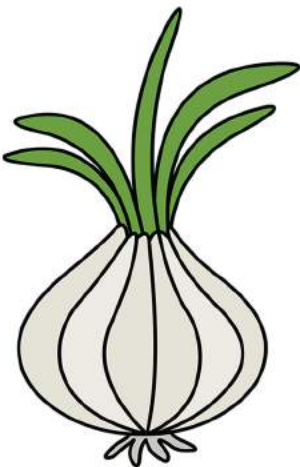

onion



ornament

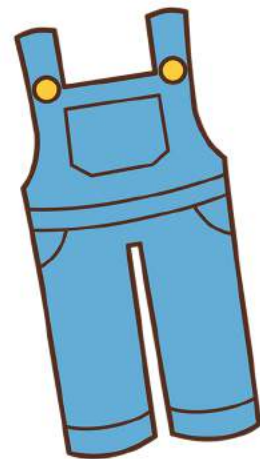

overalls

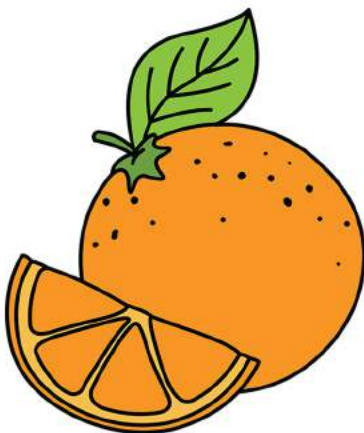

orange

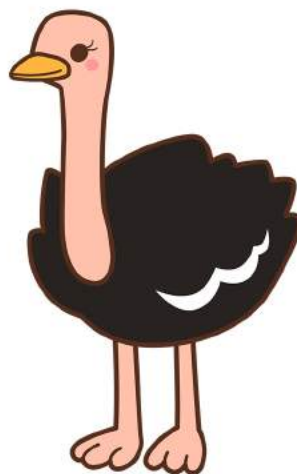

ostrich





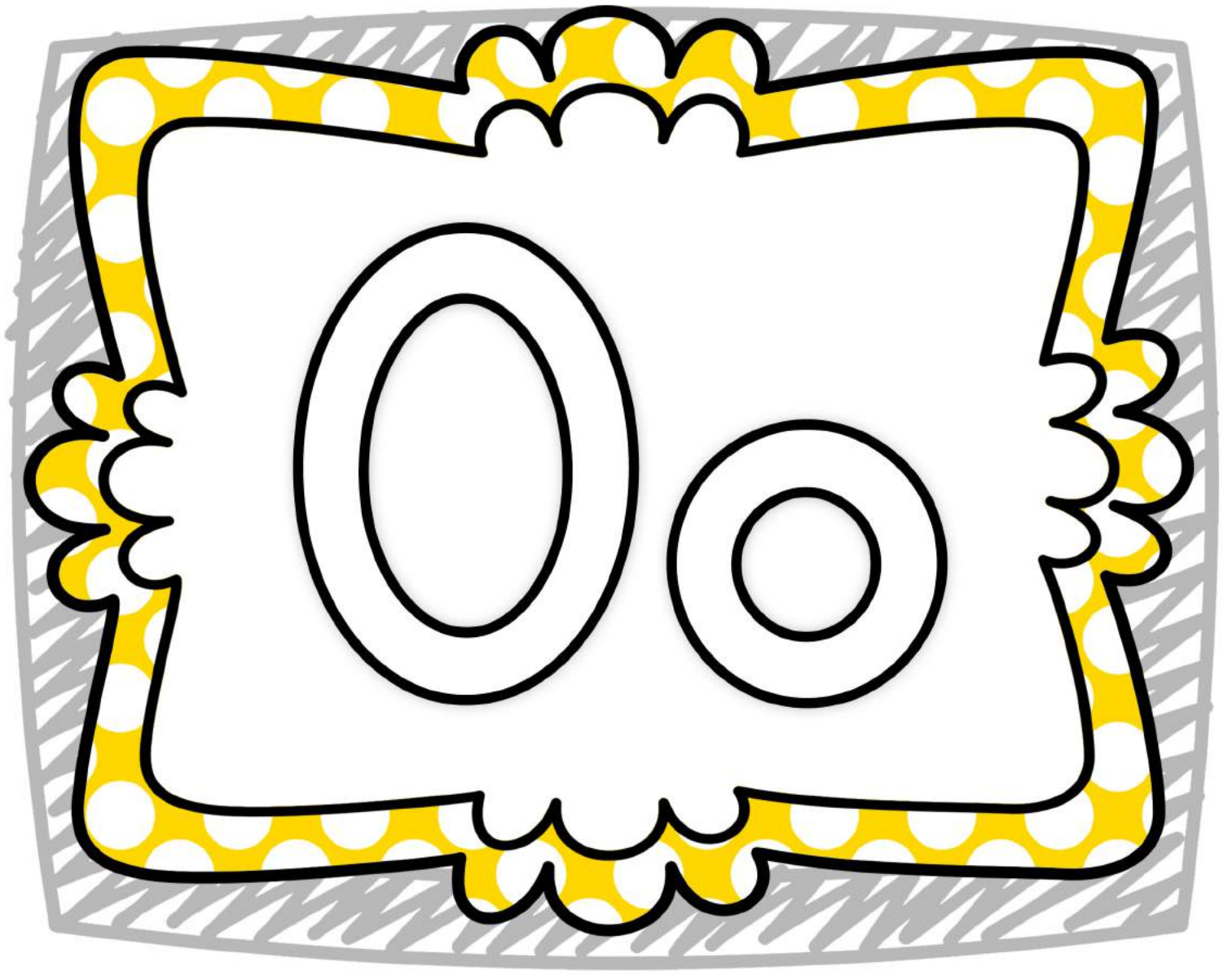











oar

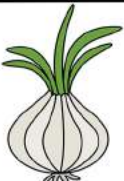

LETTER O





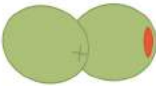











4 IN A ROW

LETTER O

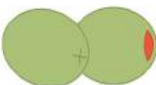

4 IN A ROW



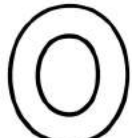









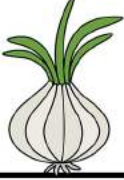

Images (c) Little Red's Clipart, Zip-a-De-Doo-Dah Designs & Miss Giraffe

LETTER O

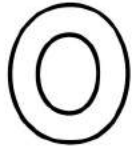



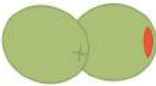









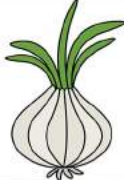

4 IN A ROW

LETTER O

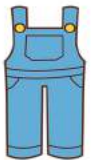

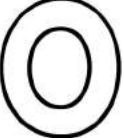
4 IN A ROW

Images (c) Little Red's Clipart, Zip-a-De-Doo-Dah Designs & Miss Giraffe

I CAN WRITE

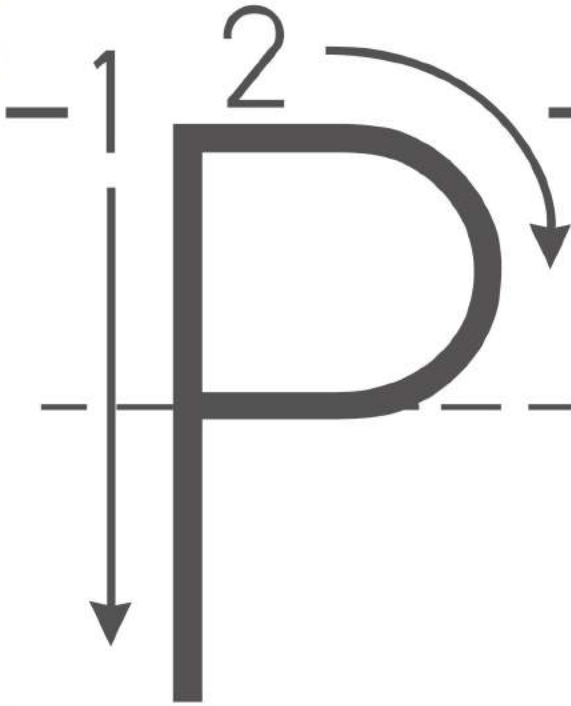

Line Down

Pick up

Big Belly

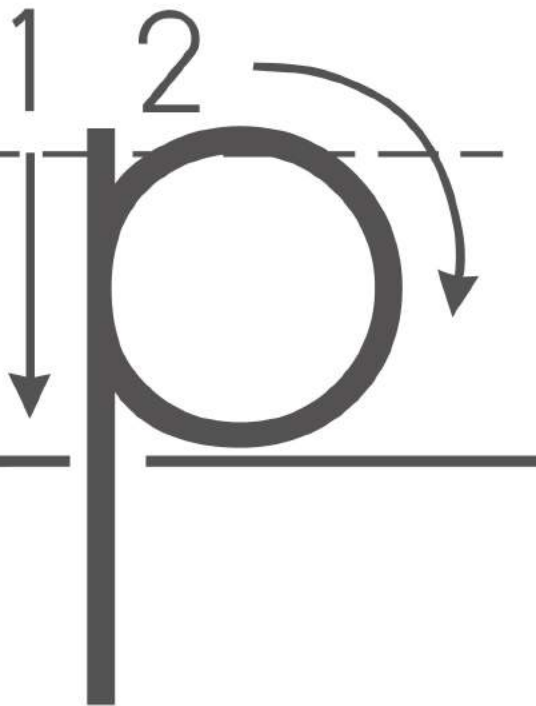

Line Down

Pick up

Little Belly

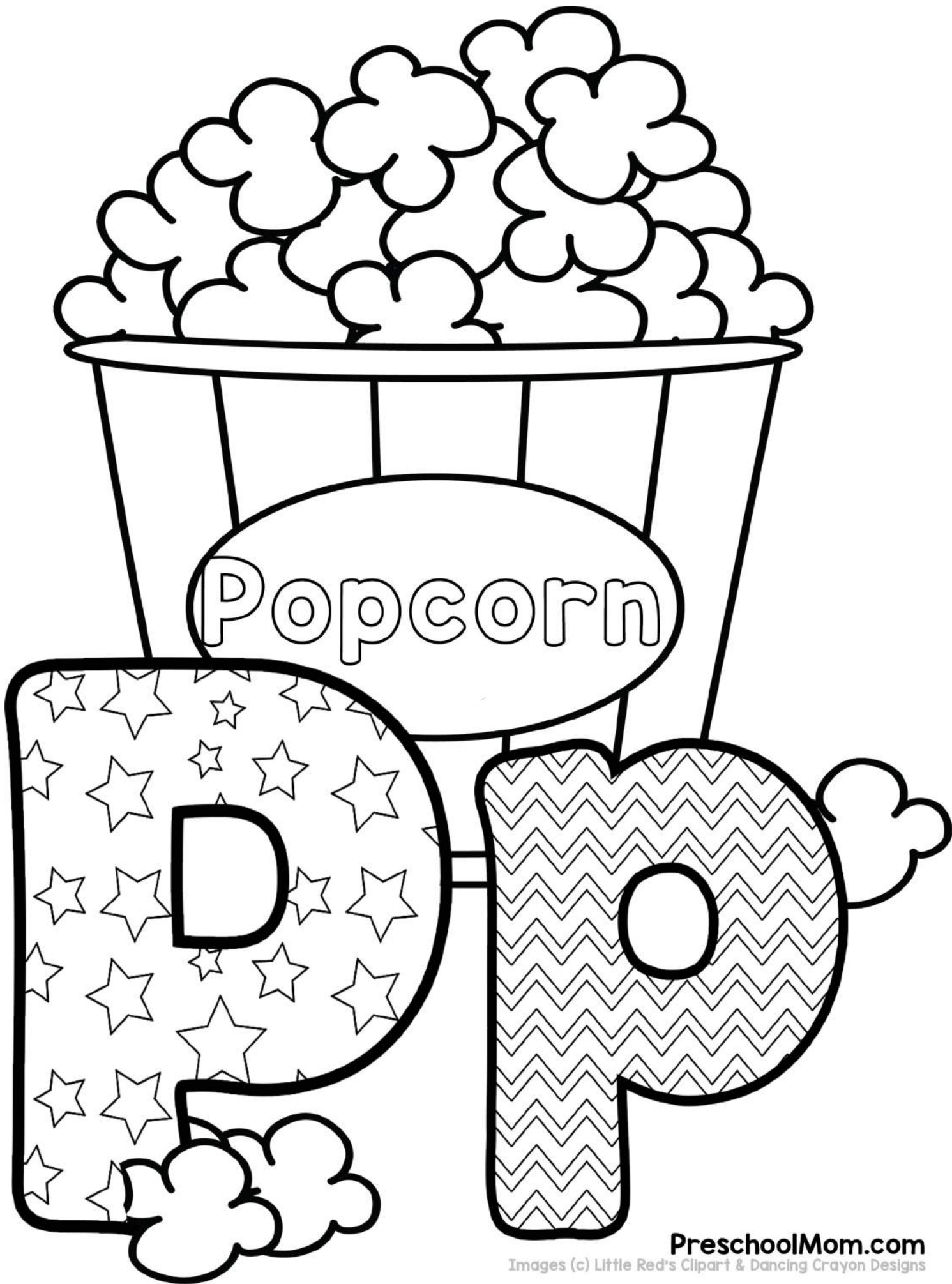

Popcorn

D

O

P p

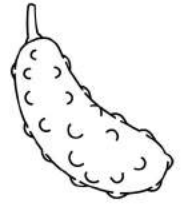
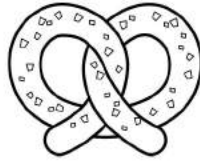
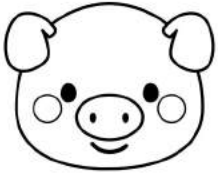
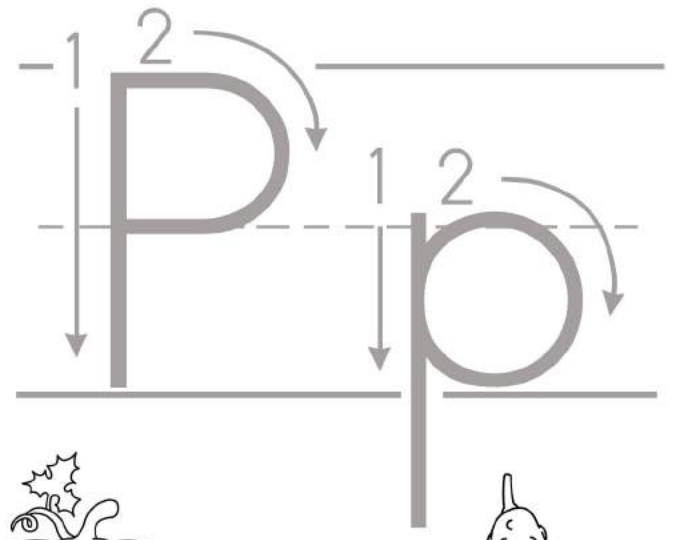

pig

pencil

pretzel

pumpkin

pizza

pickle

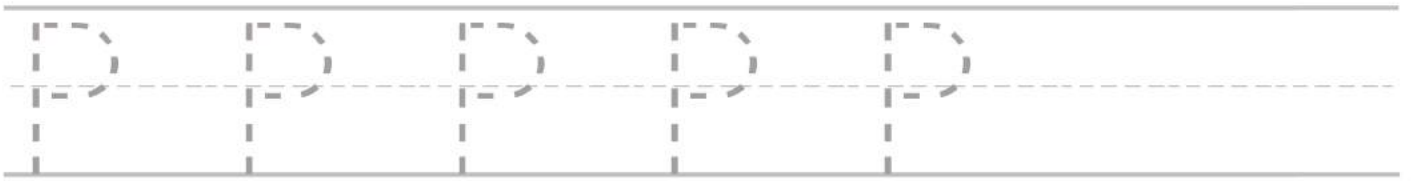
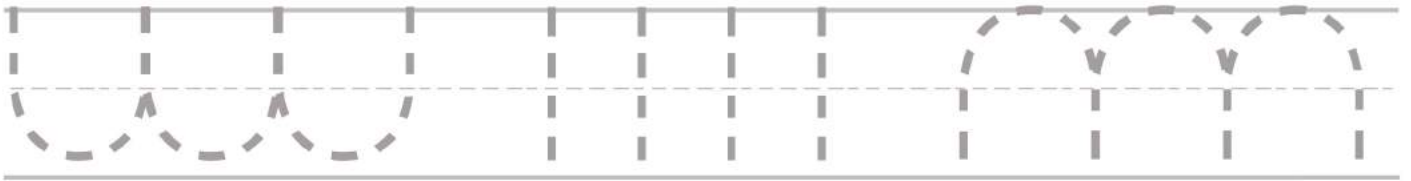

Draw 6 more kernals of popcorn:

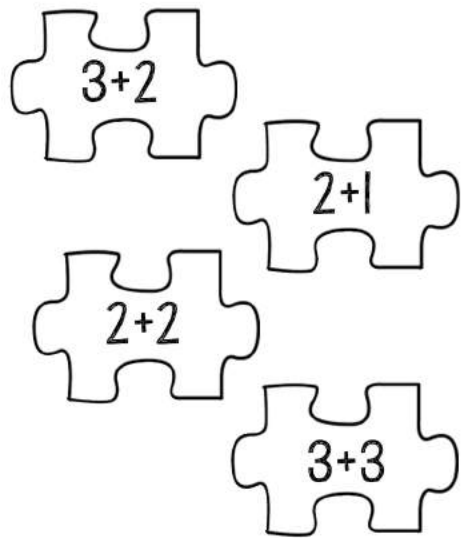
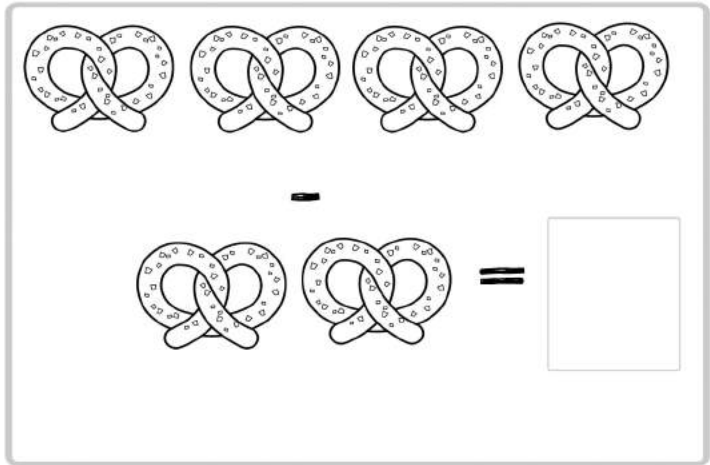

Find the right piece

Count & Tally

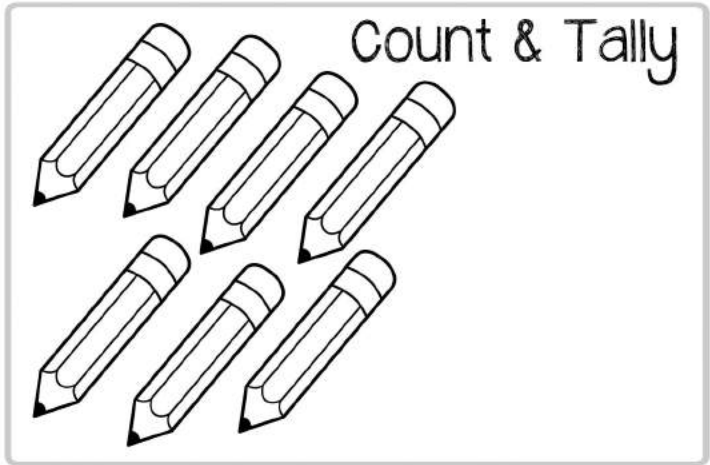

$4 - 1 = \square$
 $4 - 2 = \square$

$$\begin{array}{r} 4 \\ - 3 \\ \hline \square \end{array}$$

$$\begin{array}{r} 4 \\ - 1 \\ \hline \square \end{array}$$

Cross out the right amount of pears for the pot:

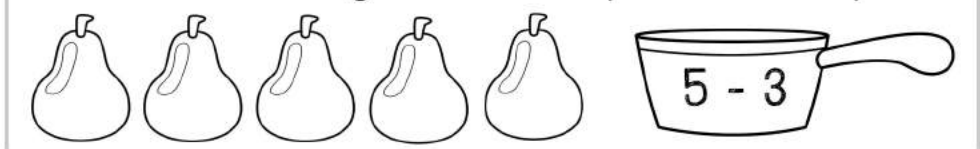

Draw flowers on the numbered plants. Count by 2's



Draw: $4 - 1 = 3$



Pp

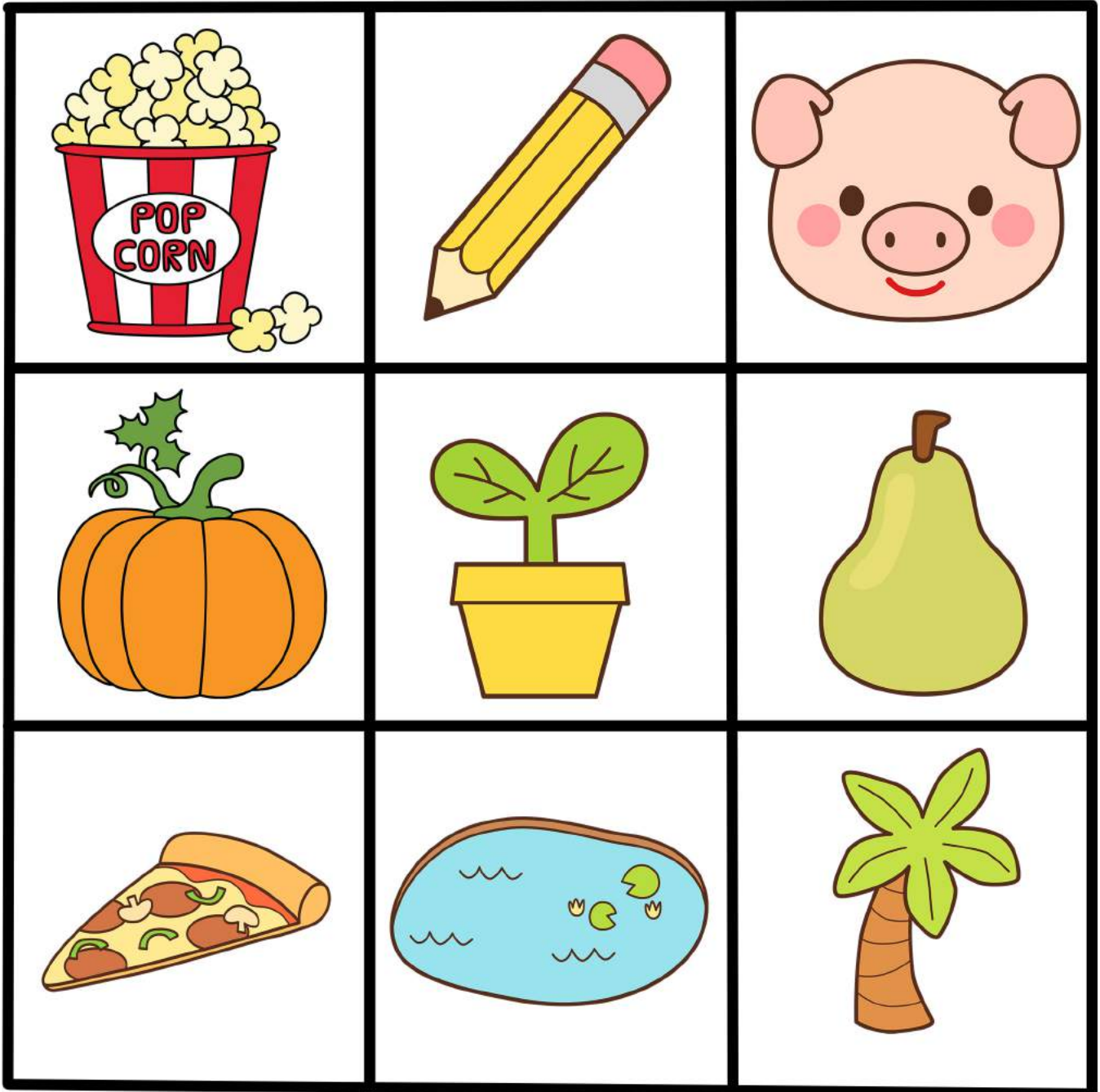
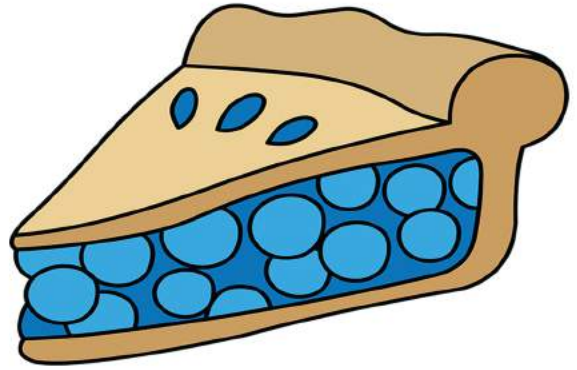

I

C A N

C O L O R

words with:

 = pizza

 = pumpkin

 = pencil

 = pickle

 = pig

 = pot

 = palm
tree

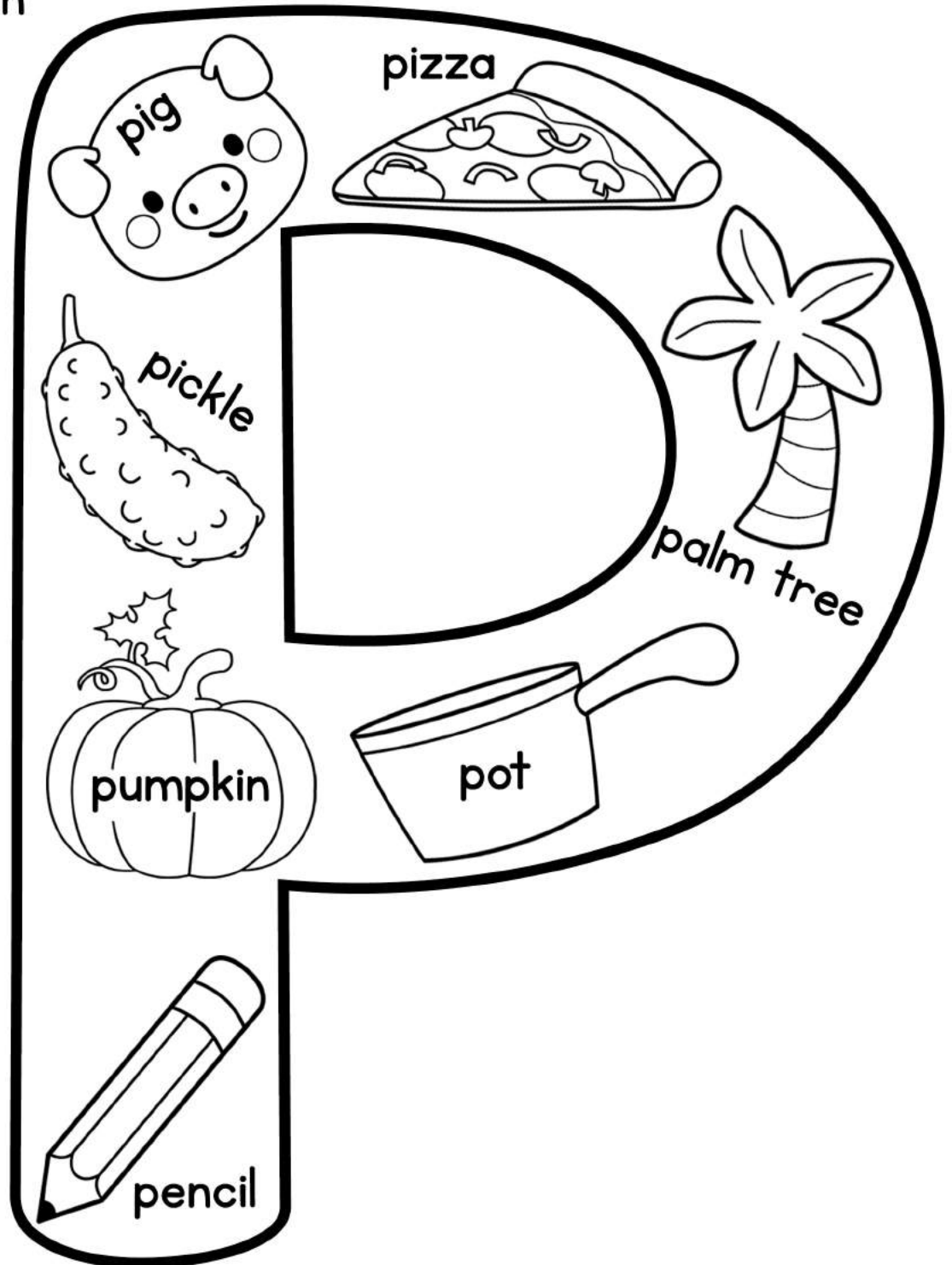

NAME : _____

Pp

Write and read words that begin with letter p.



big big big



pie pie pie



pan pan pan

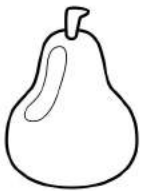

pear pear



pond pond



plant plant

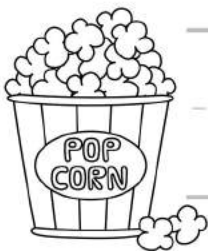

popcorn

NAME : _____

Pp

Write and read words that begin with letter p.



Pig Pig Pig



Pie Pie Pie

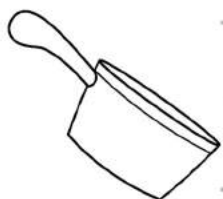

Pan Pan Pan



Pear Pear



Pond Pond



Plant Plant

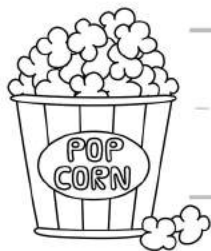

Popcorn

NAME : _____

RACE TO THE TOP

Use a paperclip and a pencil to complete the spinner.

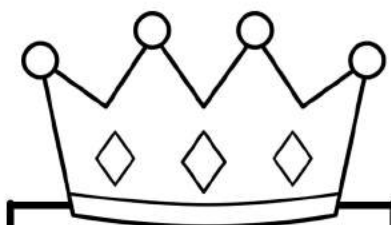

P	p
P	p
P	p
P	p
P	p
P	p
P	p
P	p
P	p
P	p

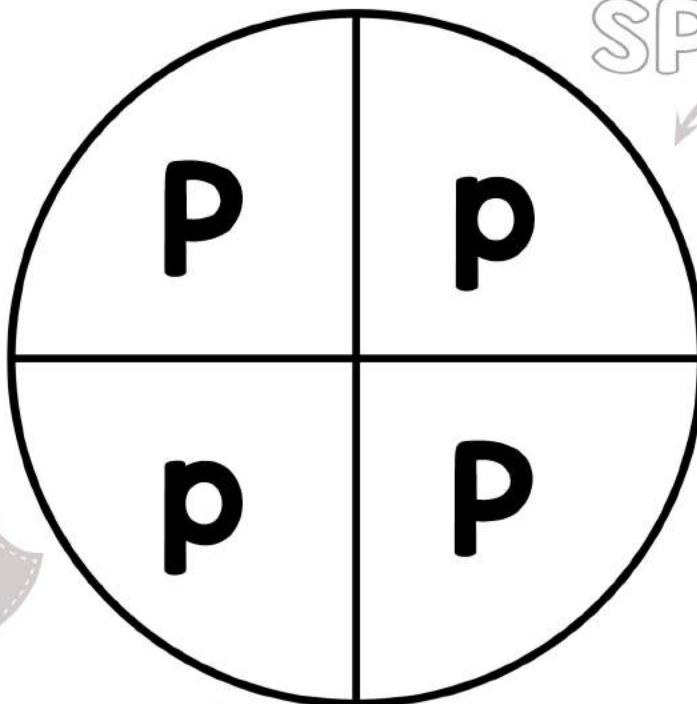

SPIN



Record

Report:

How many spins landed on P?

How many spins landed on p?

Which had more?

Write an inequality: >

How many spins total?

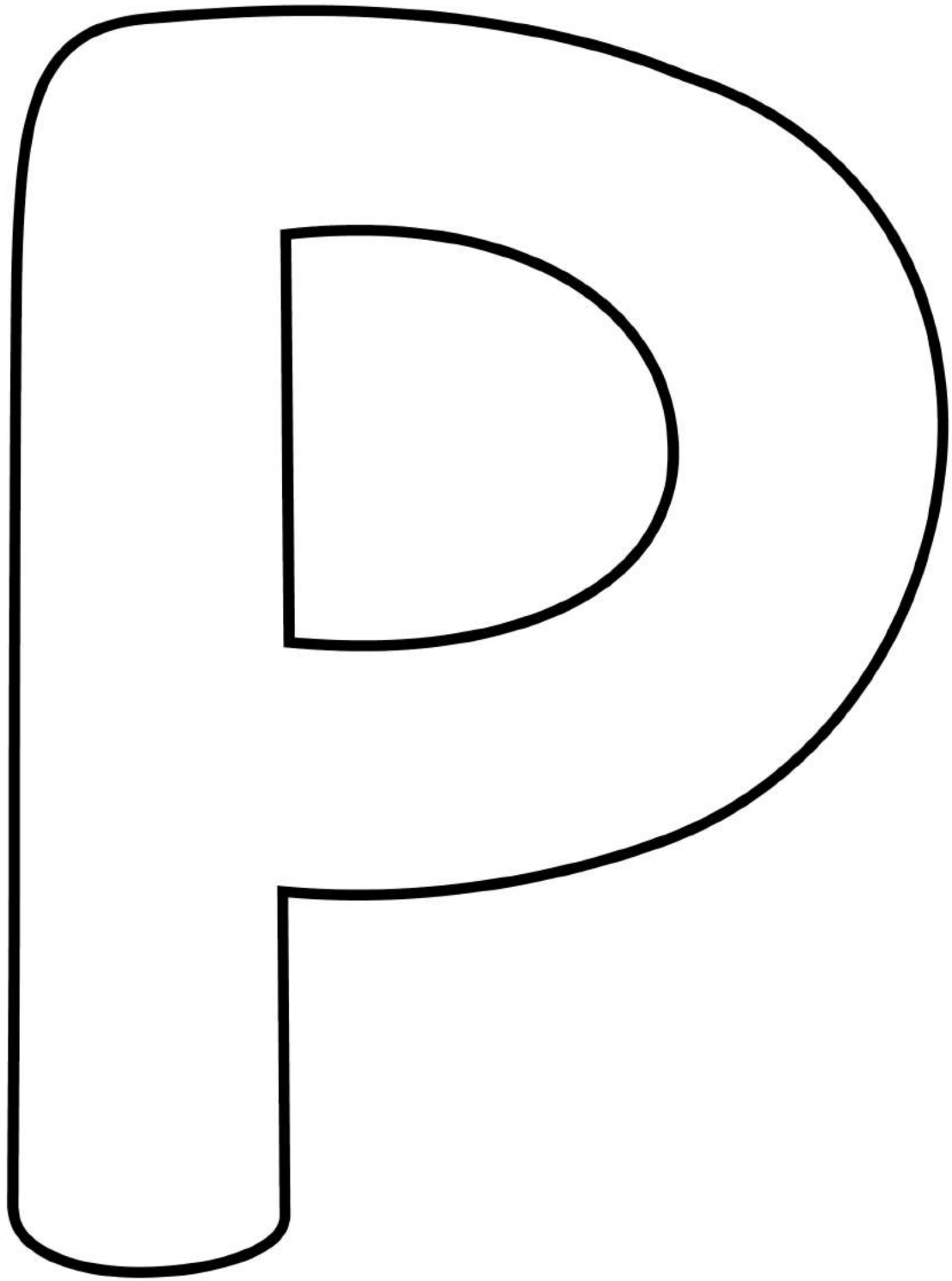

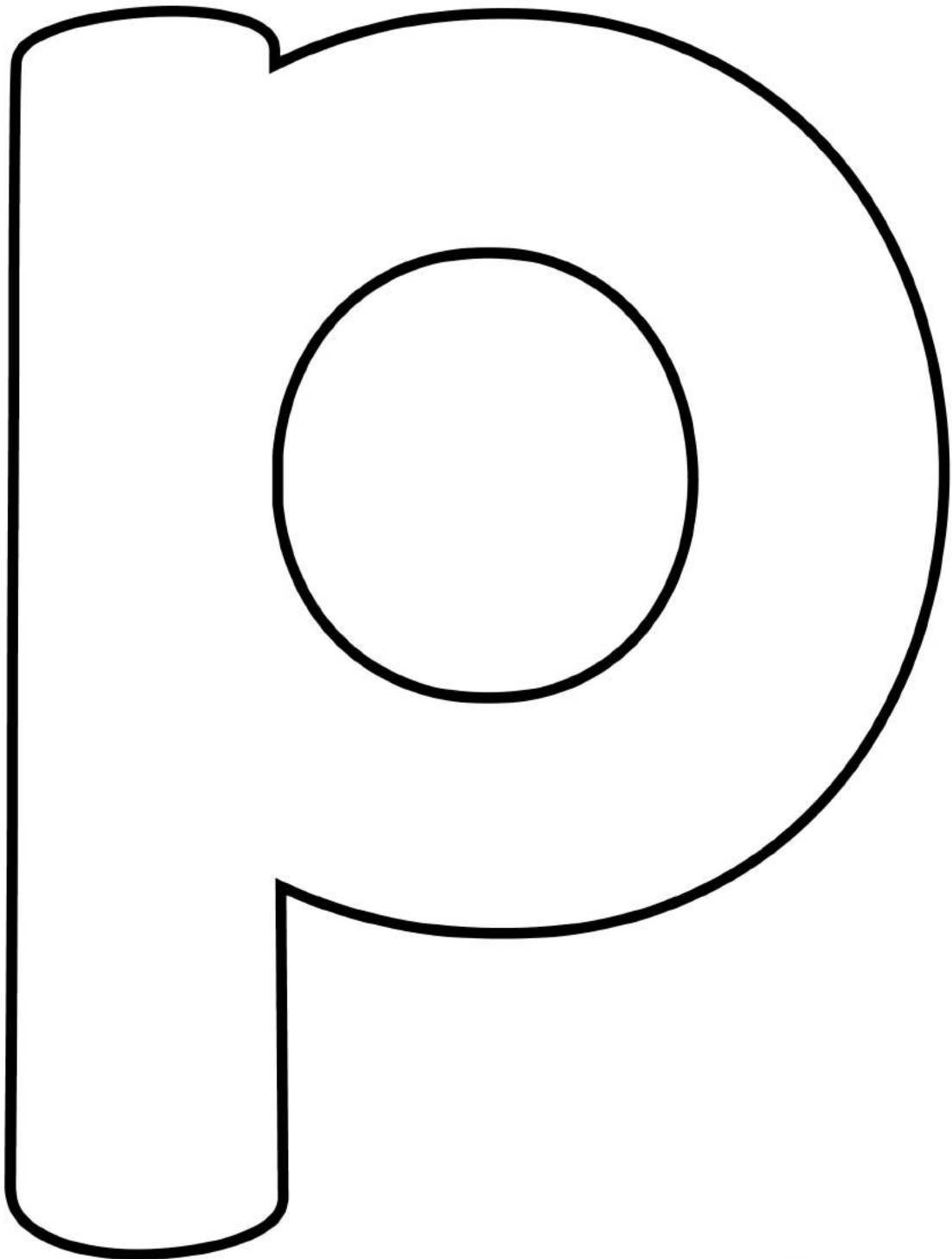

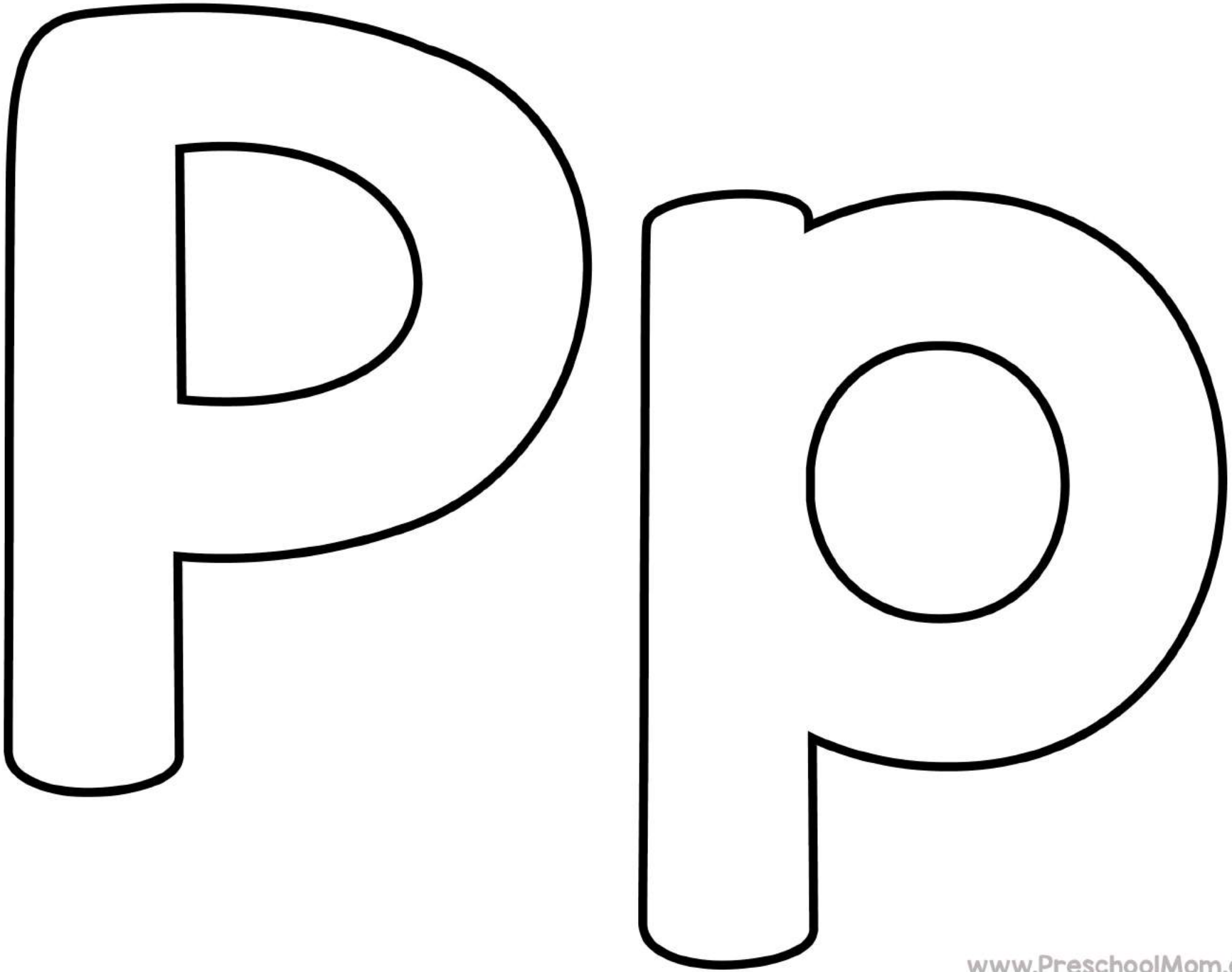

I C A N

F I N D

the letter:

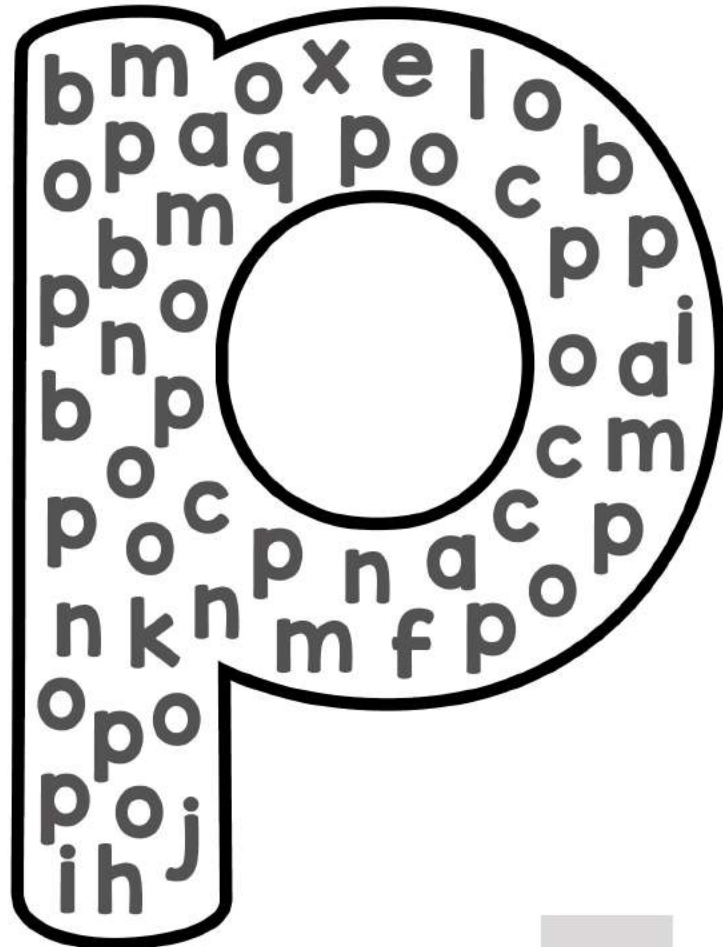
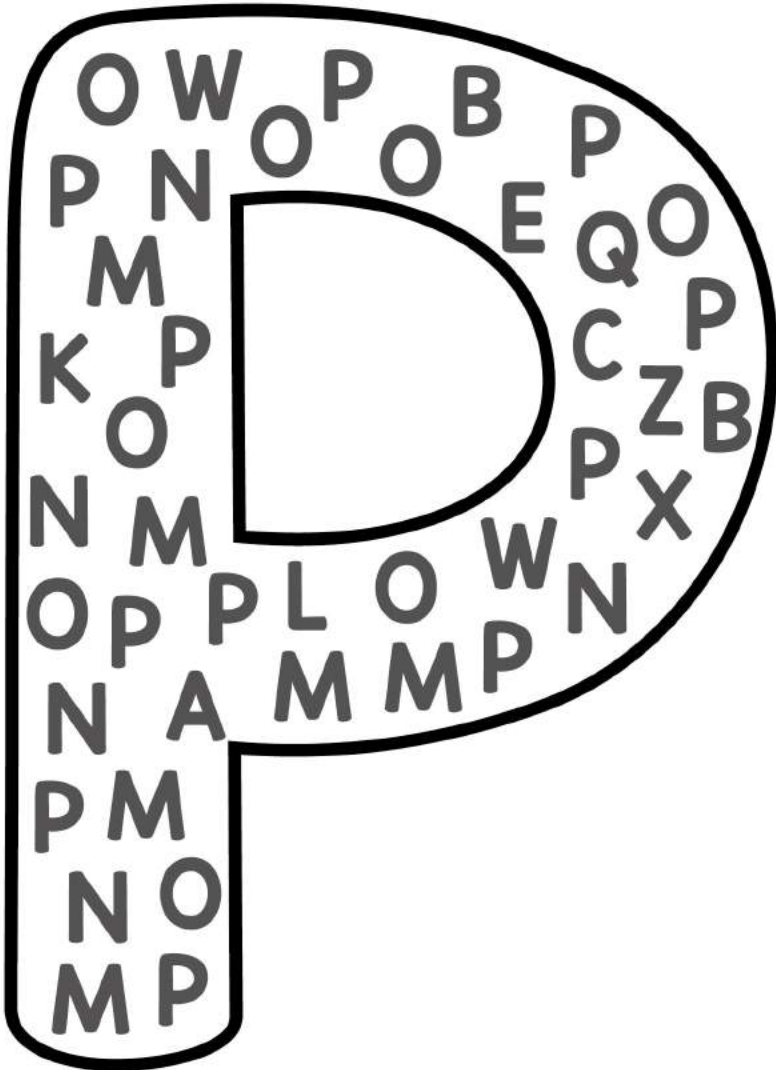

How Many?

How Many?

TRACE

NAME : _____

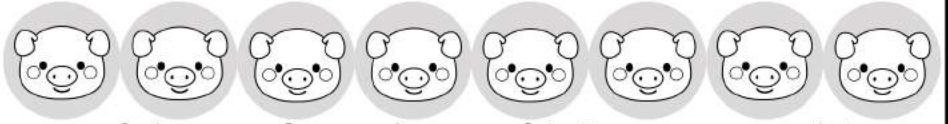

Color one for each row of letters you complete



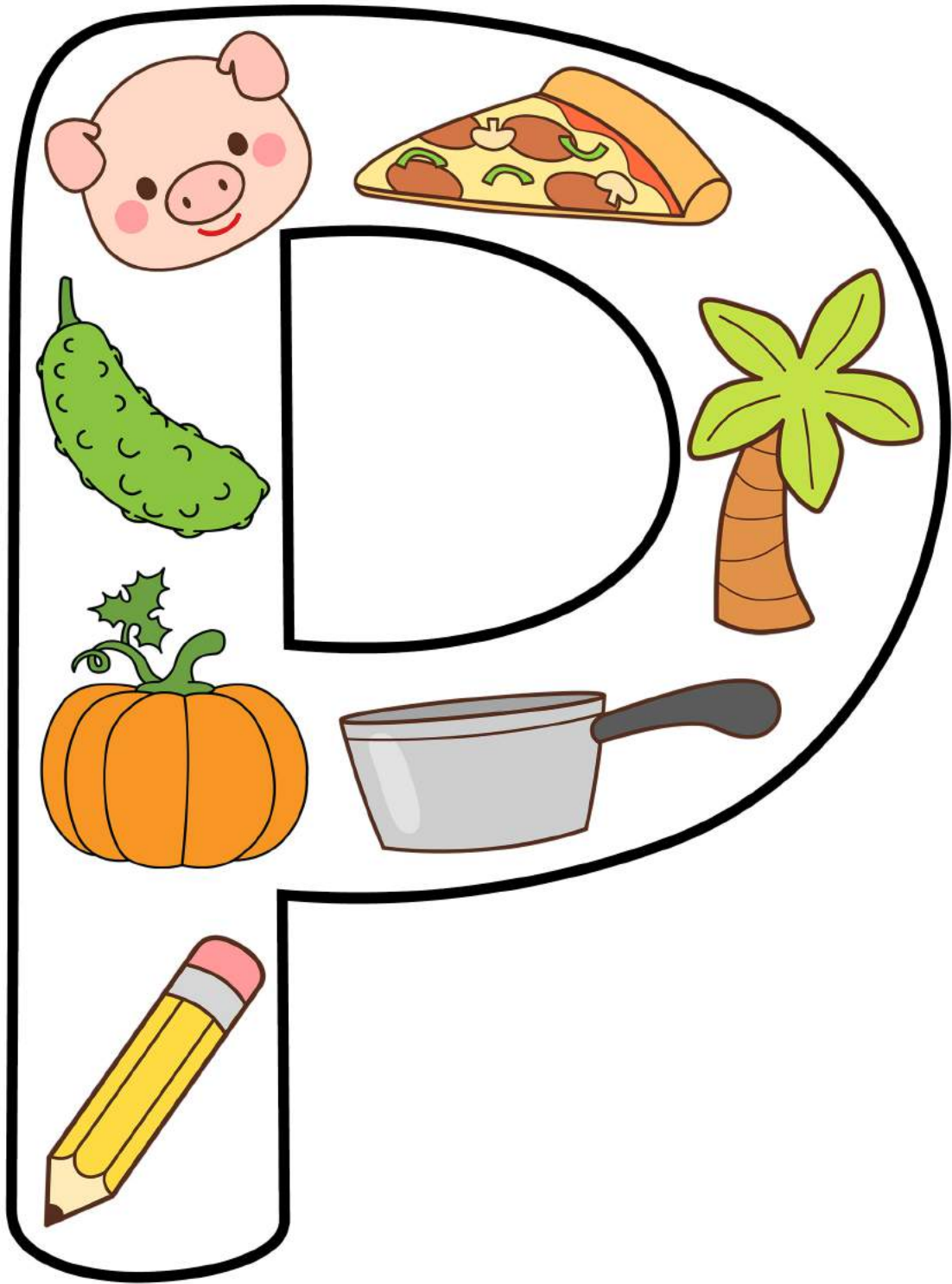

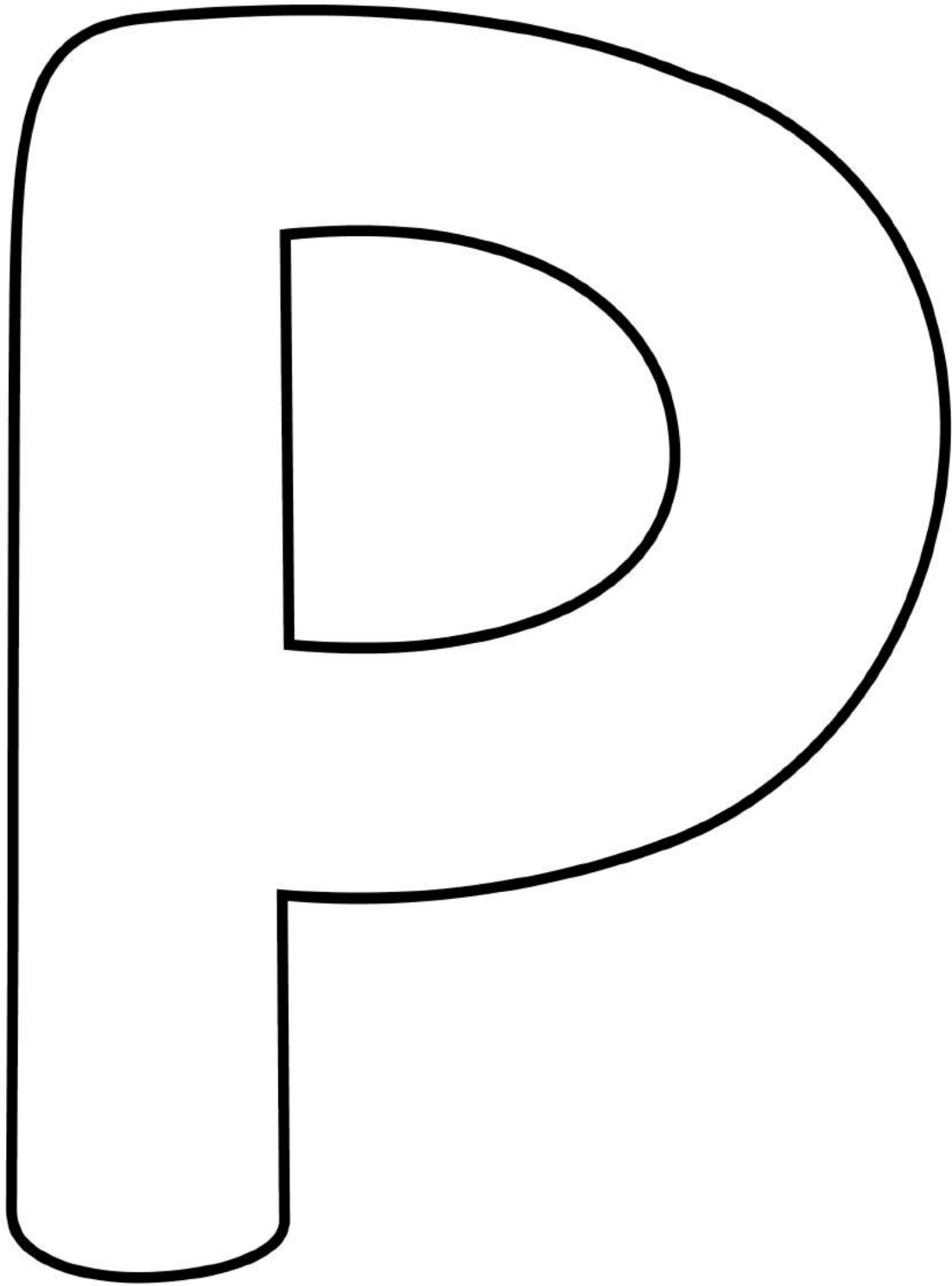

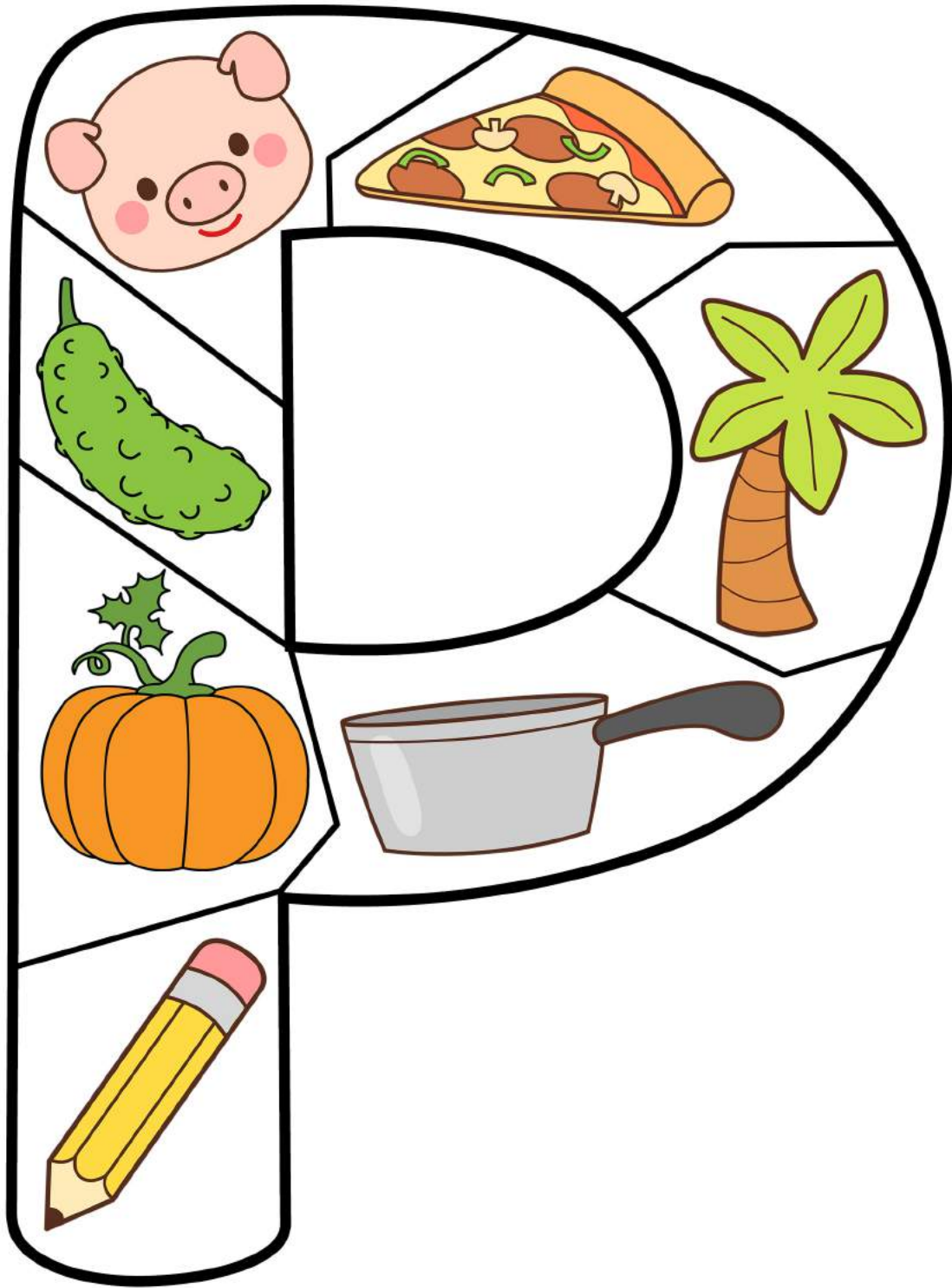

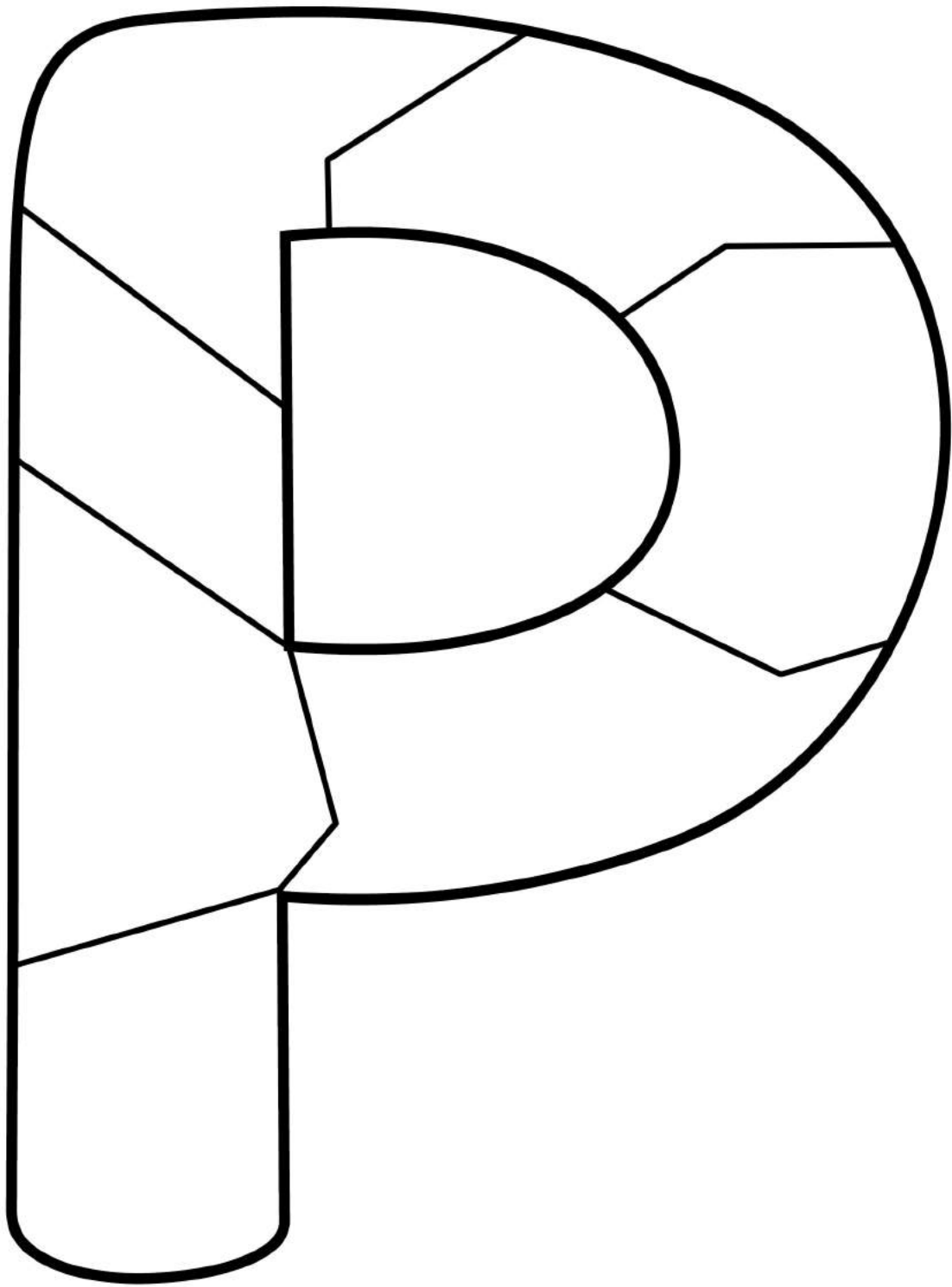

1. Write

2. Cut Out 

NAME : _____

P P

P P

P P

P P

P P

A B C Q U I L T

3. Color

4. Cut out 

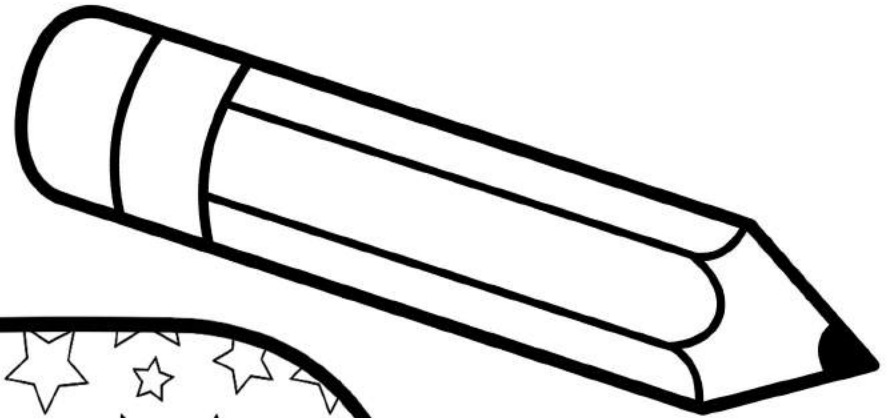

NAME : _____

NAME : _____

Pp

Write and read words that begin with letter p.



ig ig ig



ie ie ie



an an an

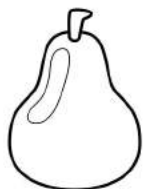

ear ear



ond ond



lant lant

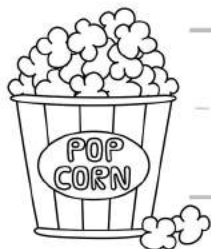

opcorn

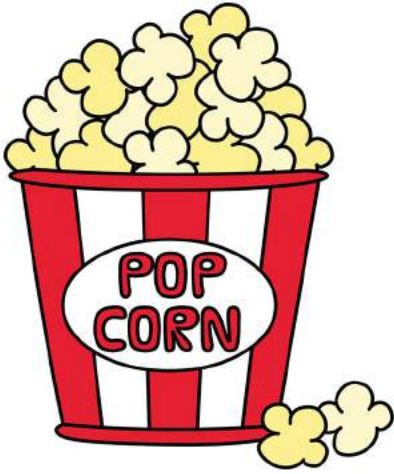

pop corn



pumpkin

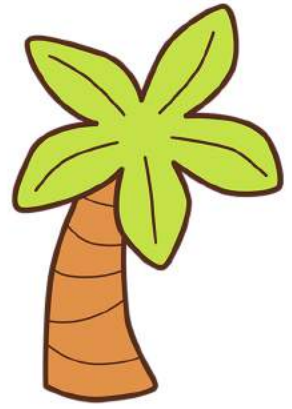

palm tree

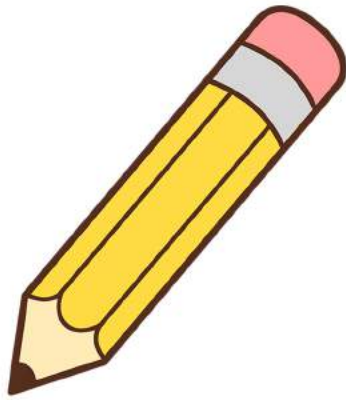

pencil

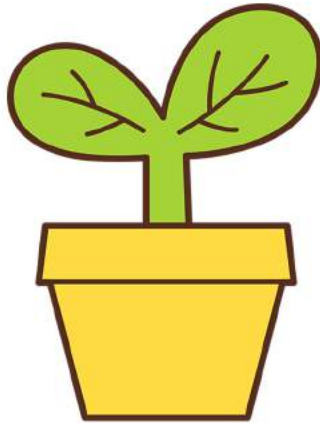

plant

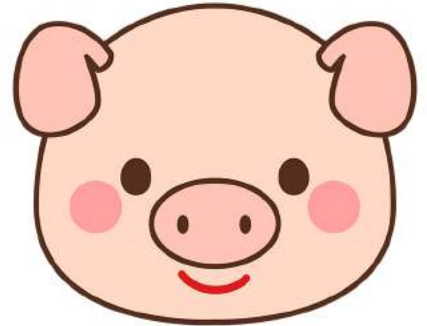

pig

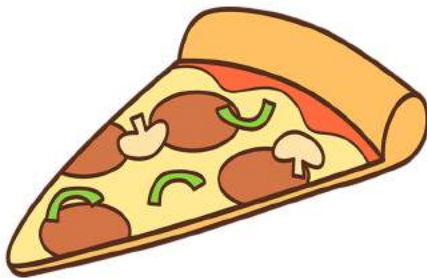

pizza

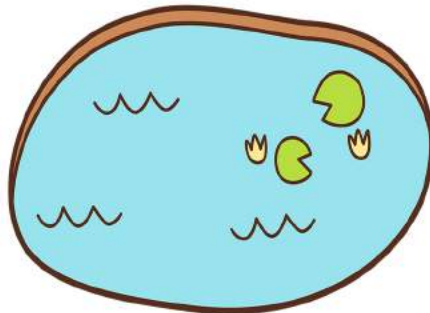

pond

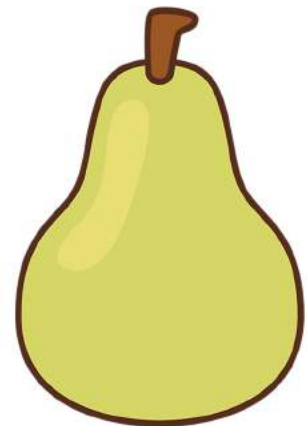



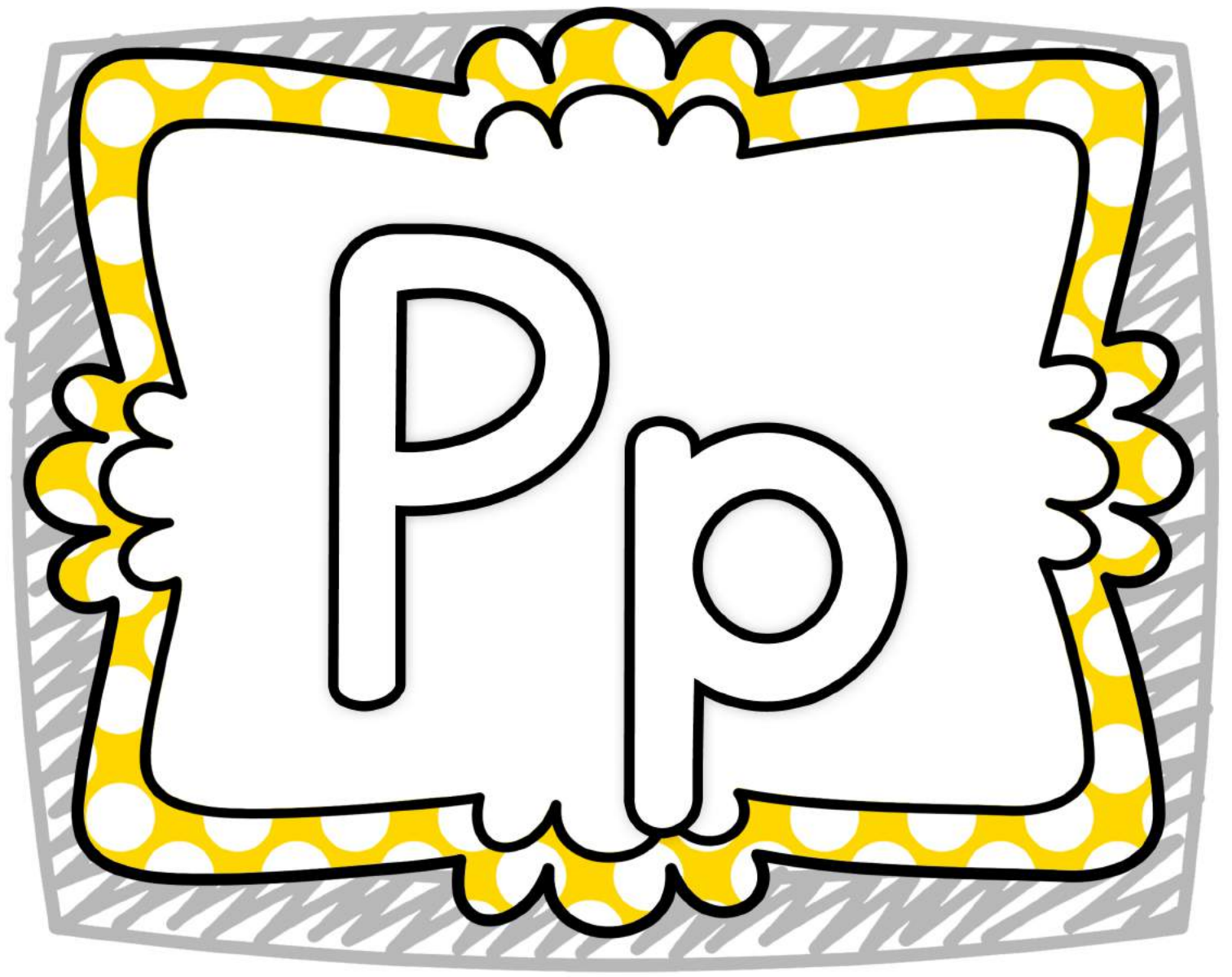











pear



LETTER P



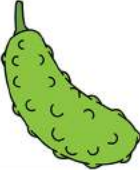









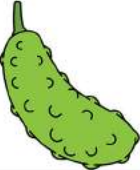



4 IN A ROW

P			
			
			p
			

LETTER P



















4 IN A ROW

			
			
		p	
P			

LETTER P

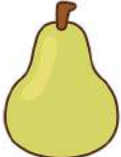

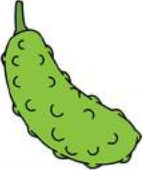













4 IN A ROW

LETTER P

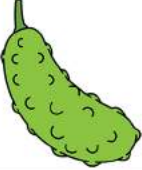

4 IN A ROW

I C A N W R I T E

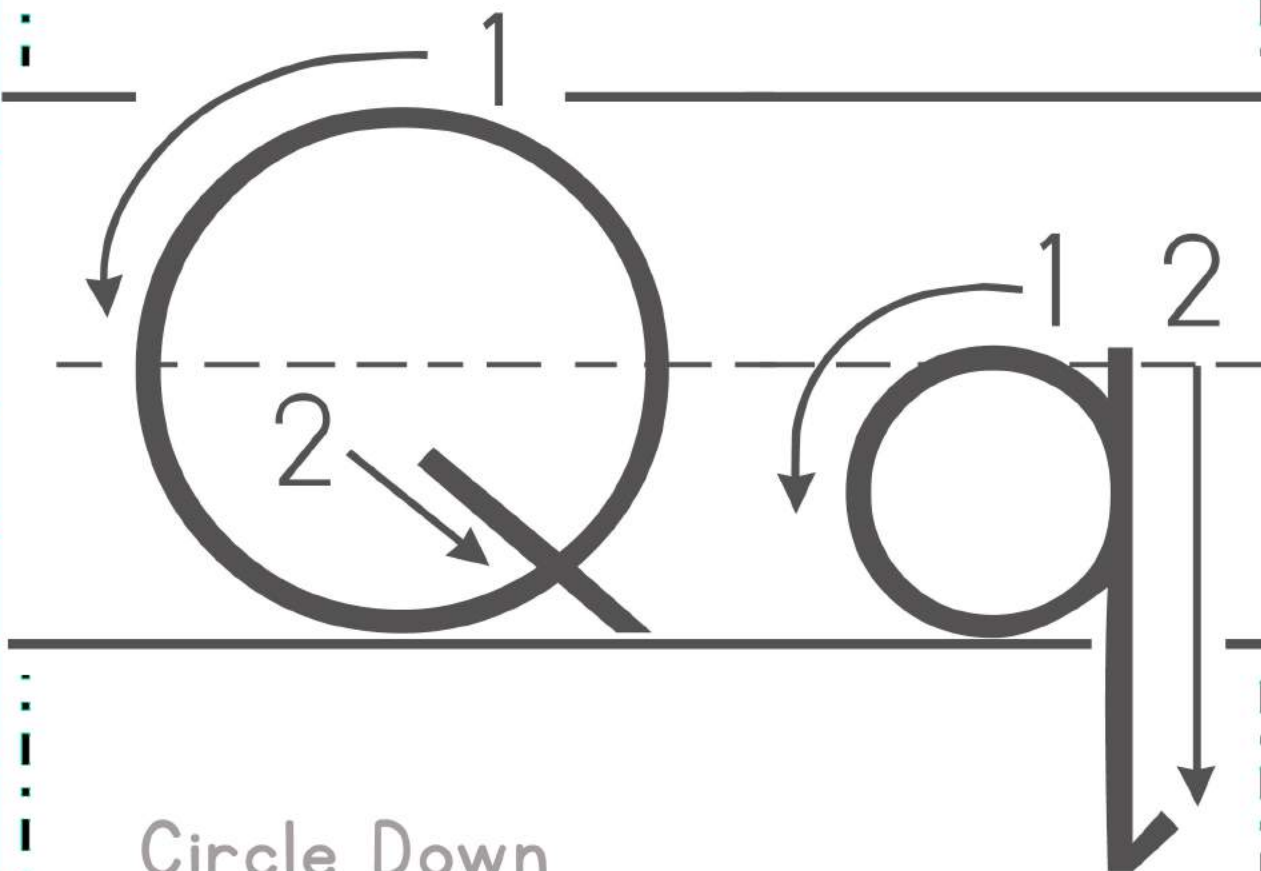

Circle Down
and Around
Pick up
Kick Down

Circle Down
and Around
Pick up
Line Down
Flick up

Quilt

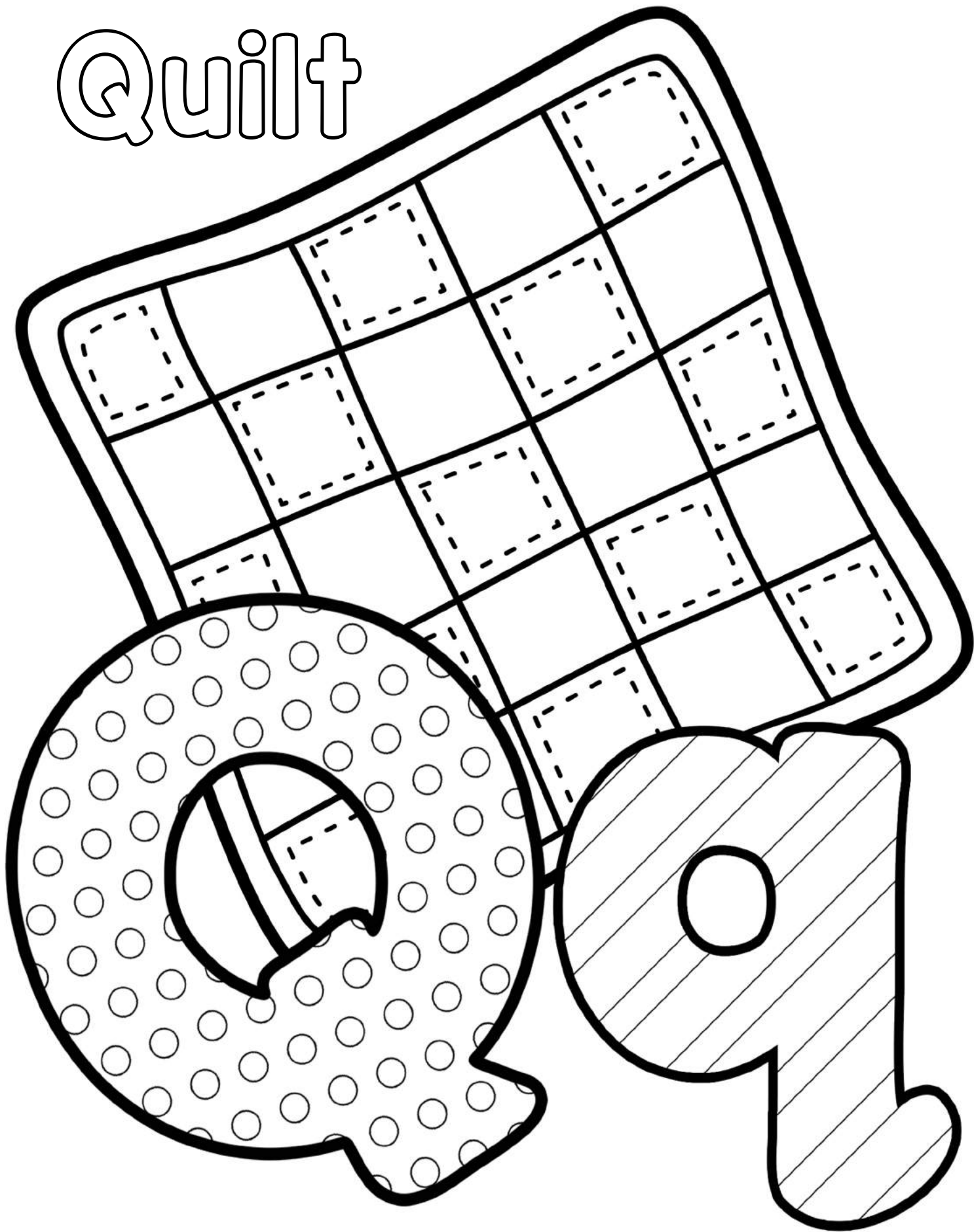

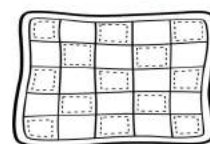
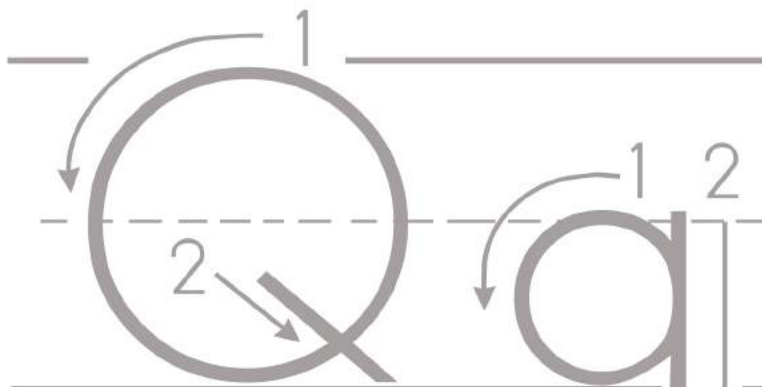

queen

quiver

quarter

quail

quill

quilt

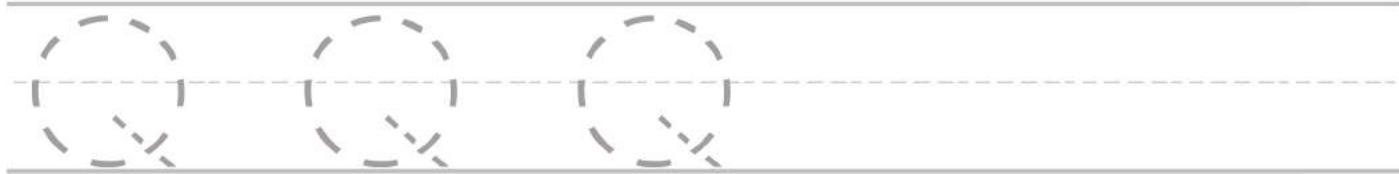

Which piece is the missing quarter?

Color the dotted quilt squares:

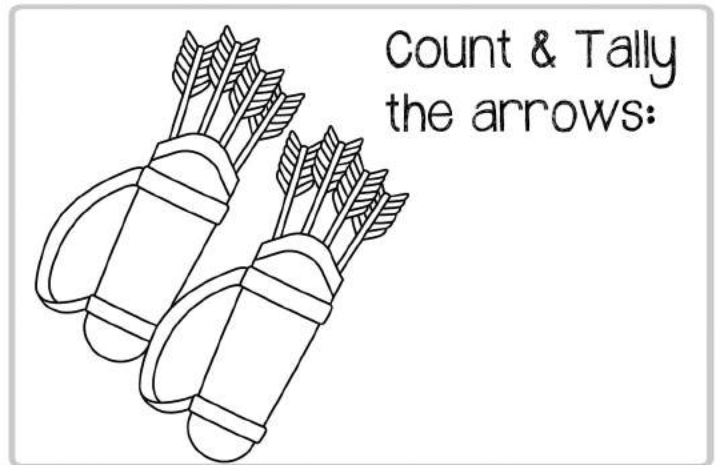
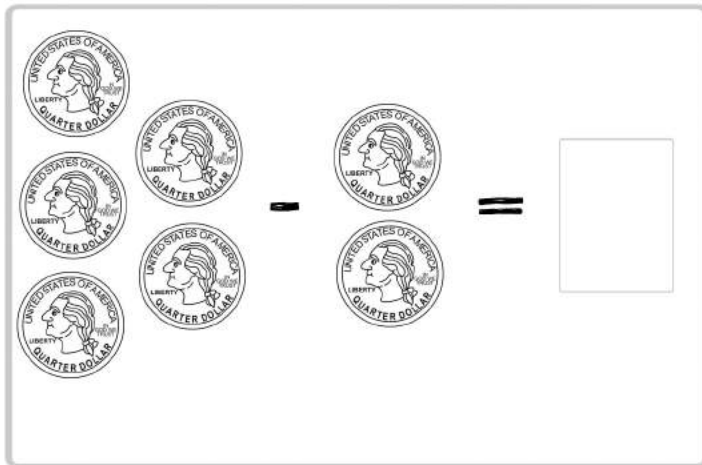
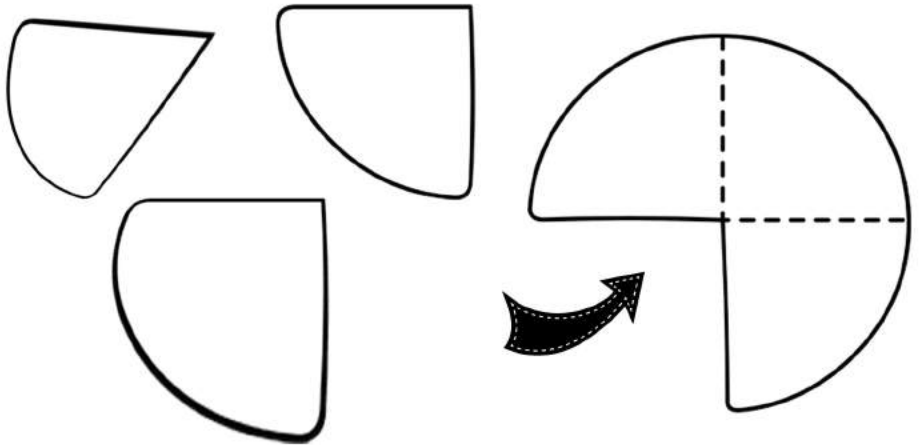
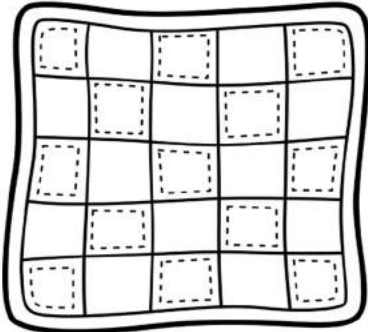

Trace every other question mark:



$5 - 1 = \square$

$5 - 2 = \square$

$$\begin{array}{r} 5 \\ - 3 \\ \hline \end{array} \quad \begin{array}{r} 5 \\ - 4 \\ \hline \end{array}$$



There were 6 questions on the quiz. Quin got 5 questions right. How many questions did Quin get wrong?

Draw: $5 - 3 = 2$

Q q

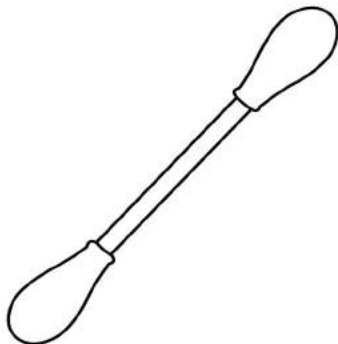
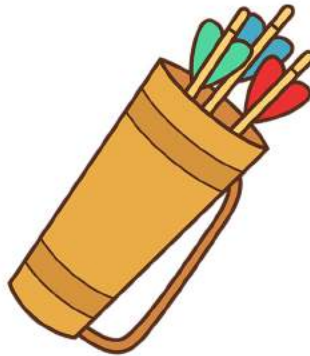
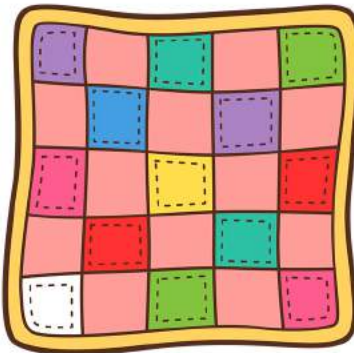
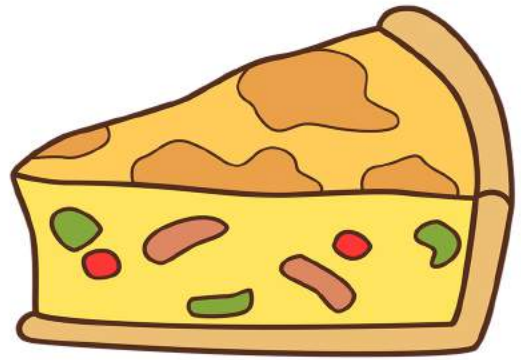

I CAN COLOR

words with:

● = queen

● = quail

● = quill

● = quilt

● = question mark

● = quarter

● = quiche

● = quiver

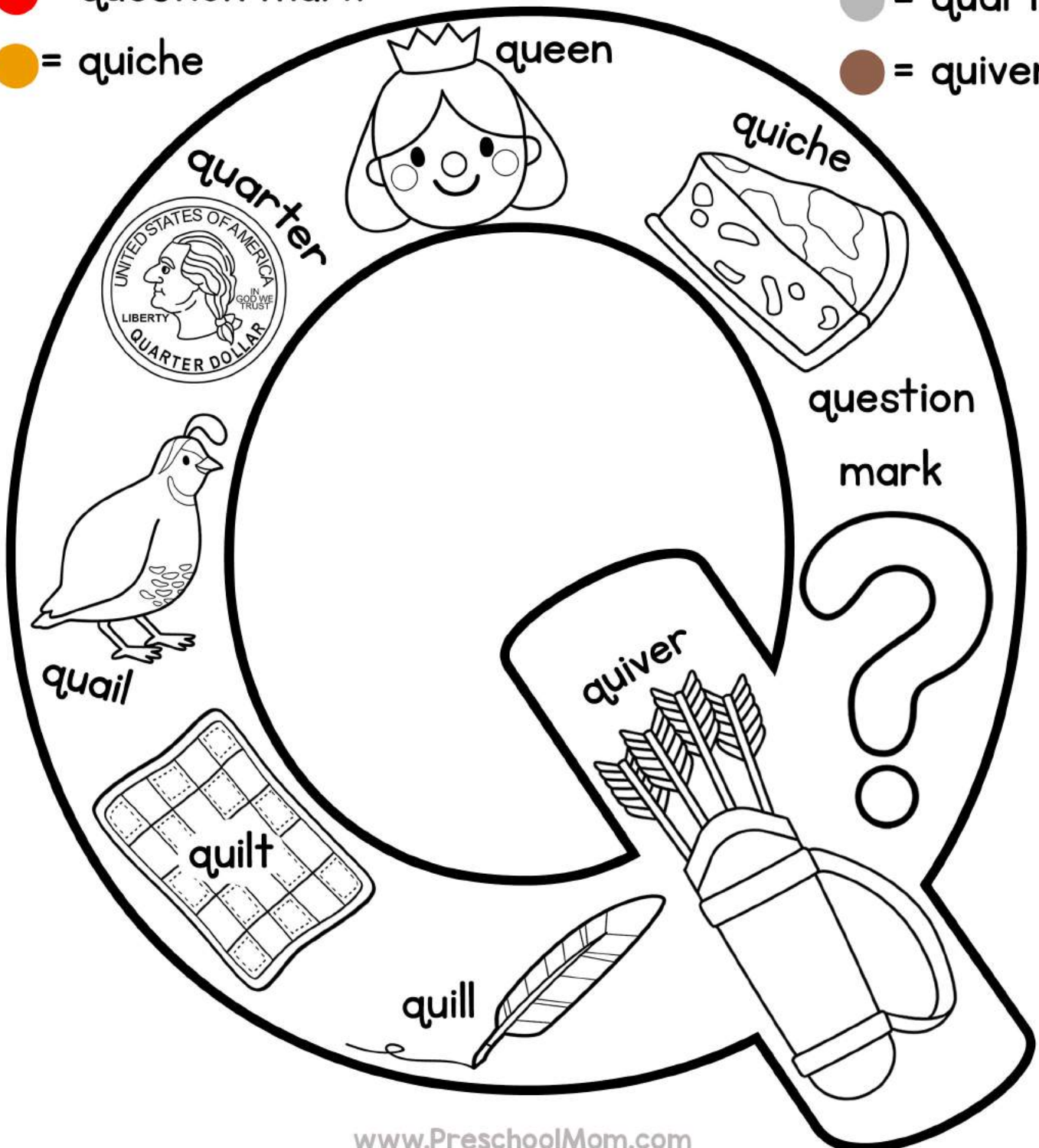

NAME : _____

Qq

Write and read words that begin with letter q,



quiz quiz



quill quill

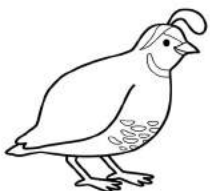

quail quail



queen queen

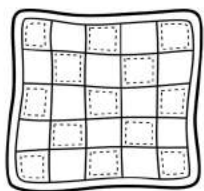

quilt quilt



quarter



question

NAME : _____

Qq

Write and read words that begin with letter q,



Quiz Quiz

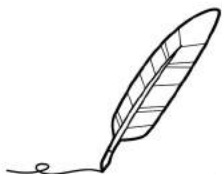

Quill Quill



Quail Quail



Queen Queen

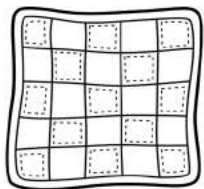

Quilt Quilt



Quarter Quarter



Question Question

NAME : _____

RACE TO THE TOP

Use a paperclip and a pencil to complete the spinner.

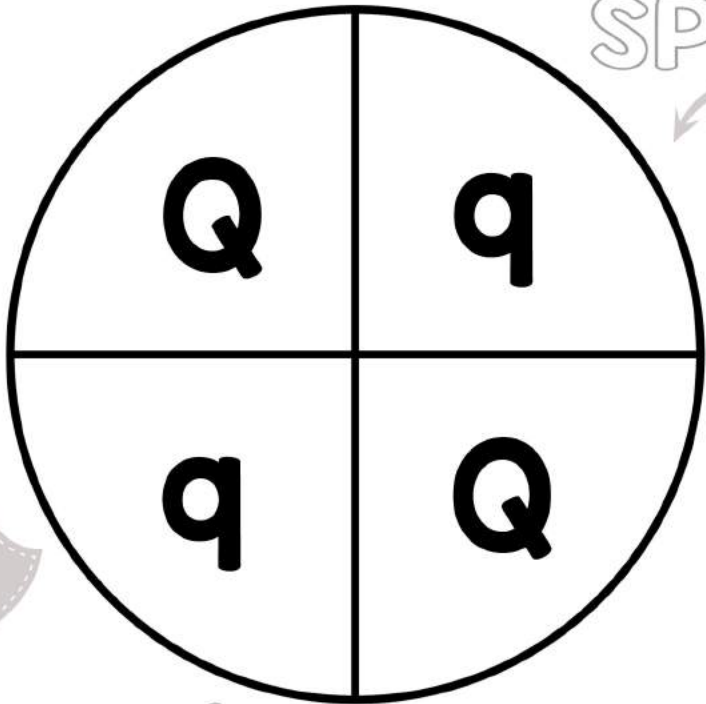

SPIN

Record

Report:

How many spins landed on Q?

How many spins landed on q?

Which had more?

Write an inequality: >

How many spins total?

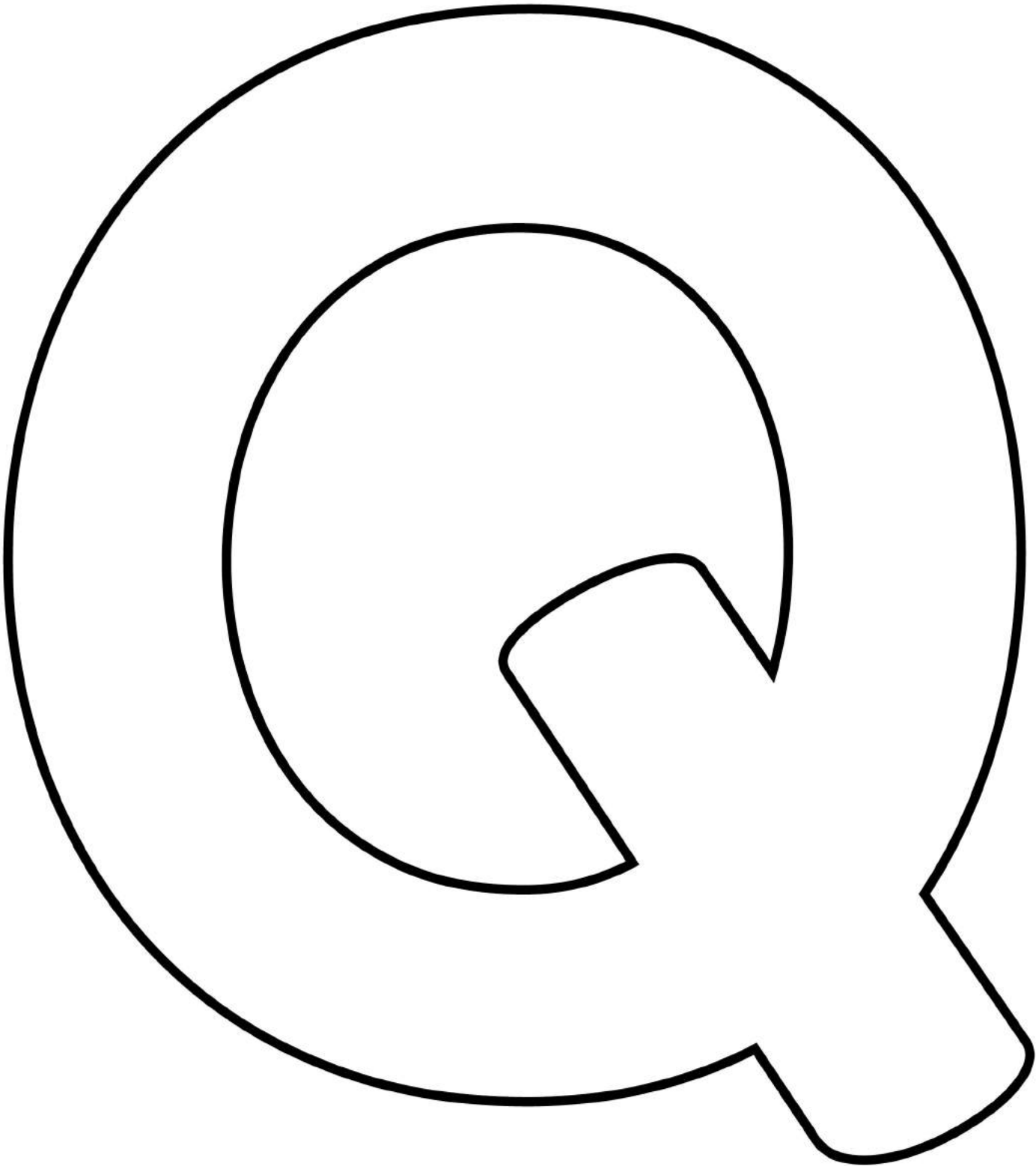

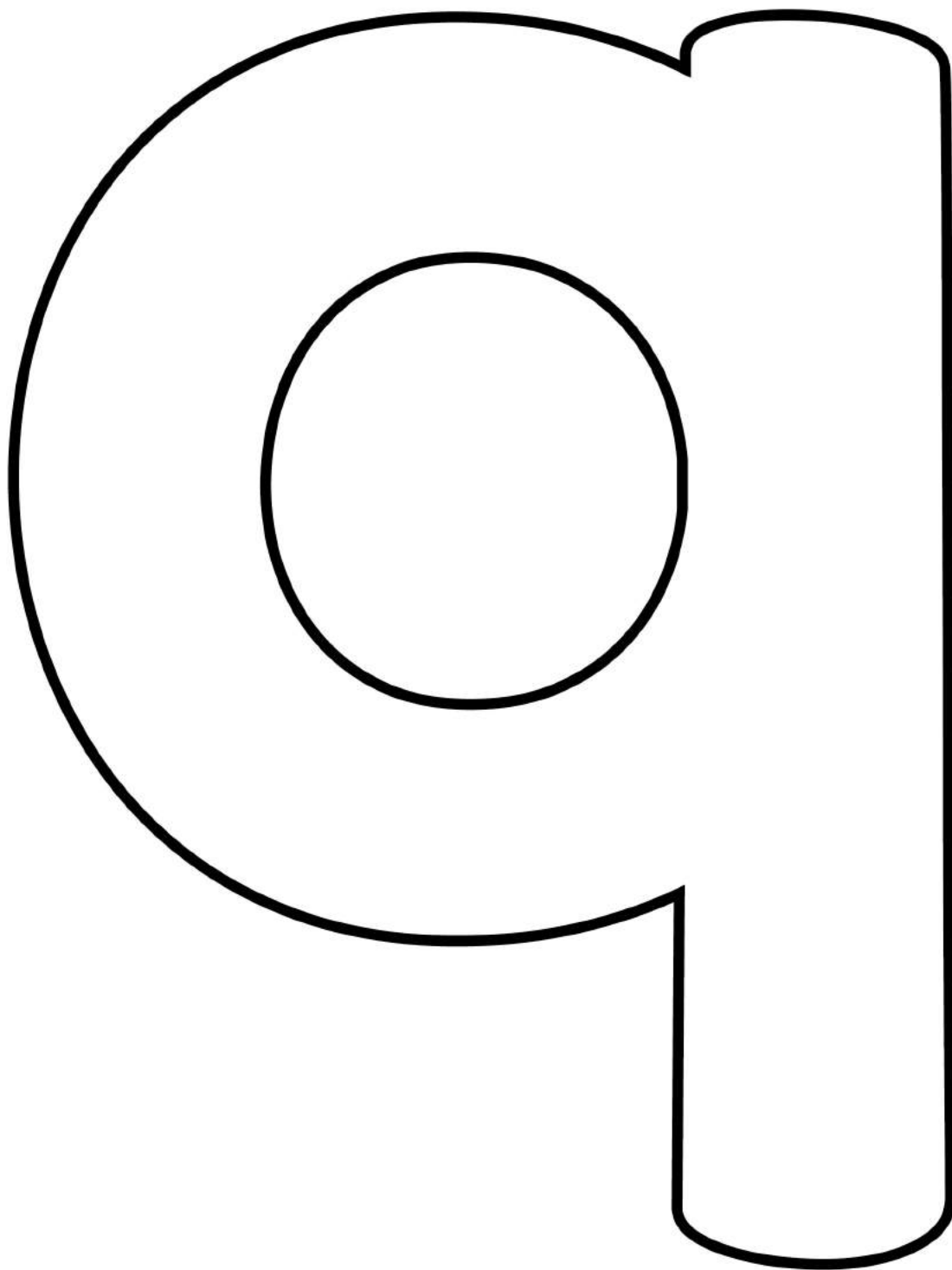

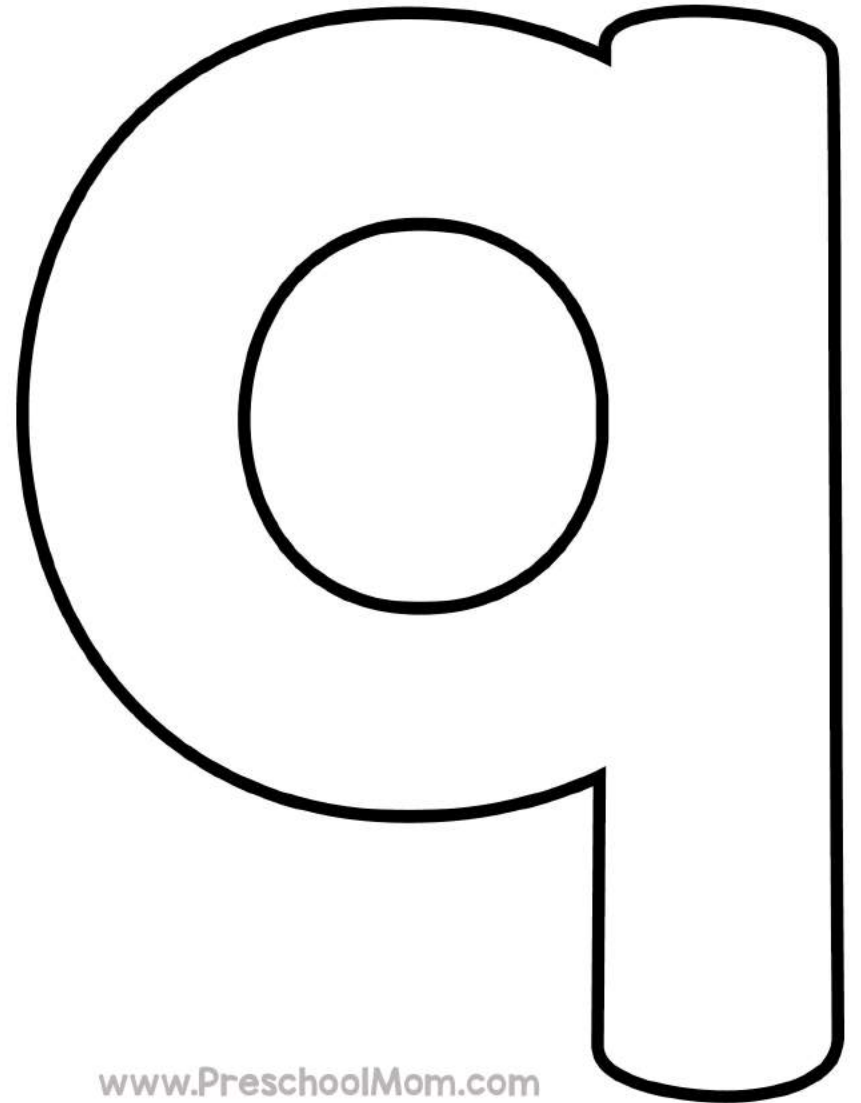
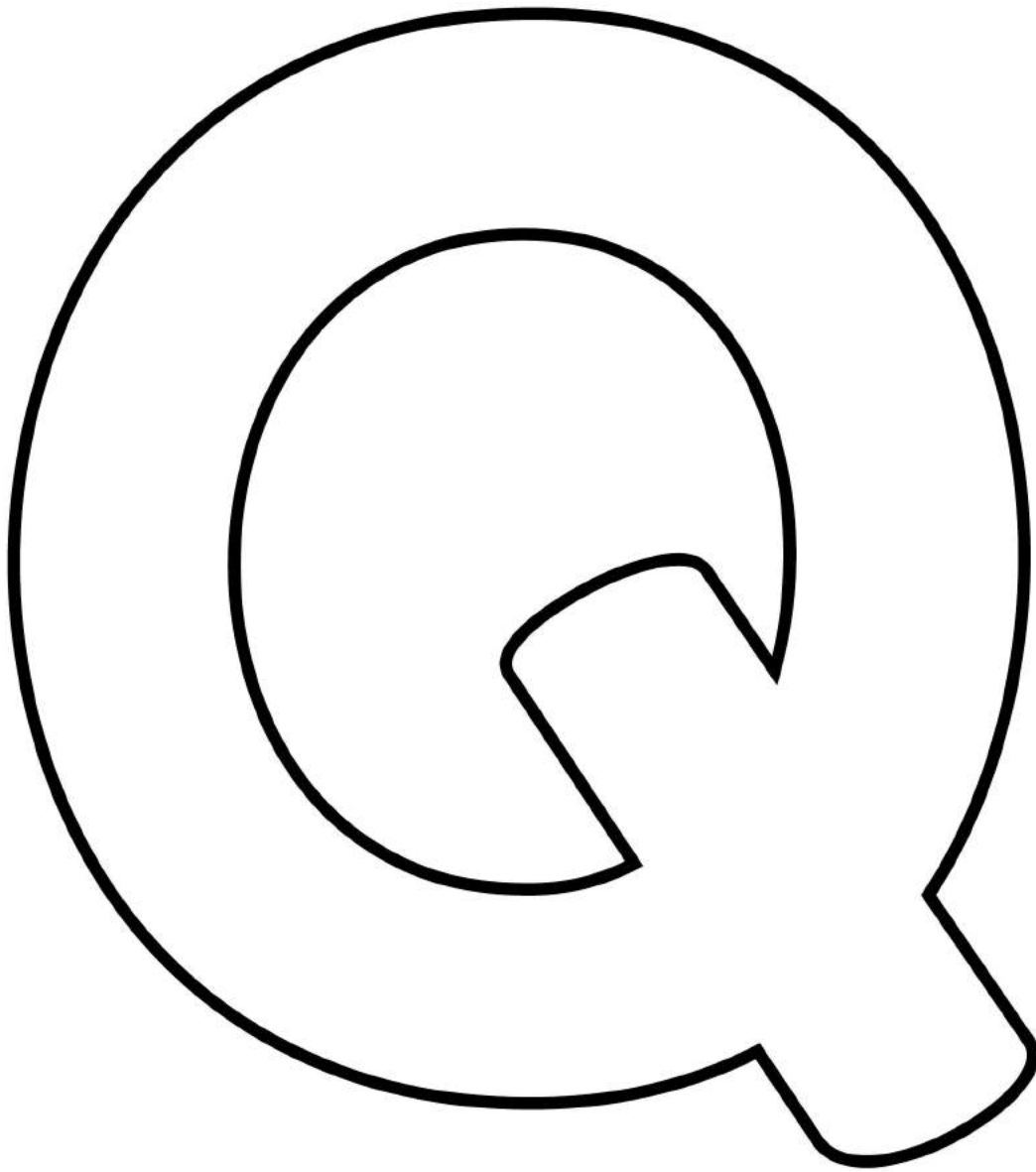

I C A N F I N D

the letter:

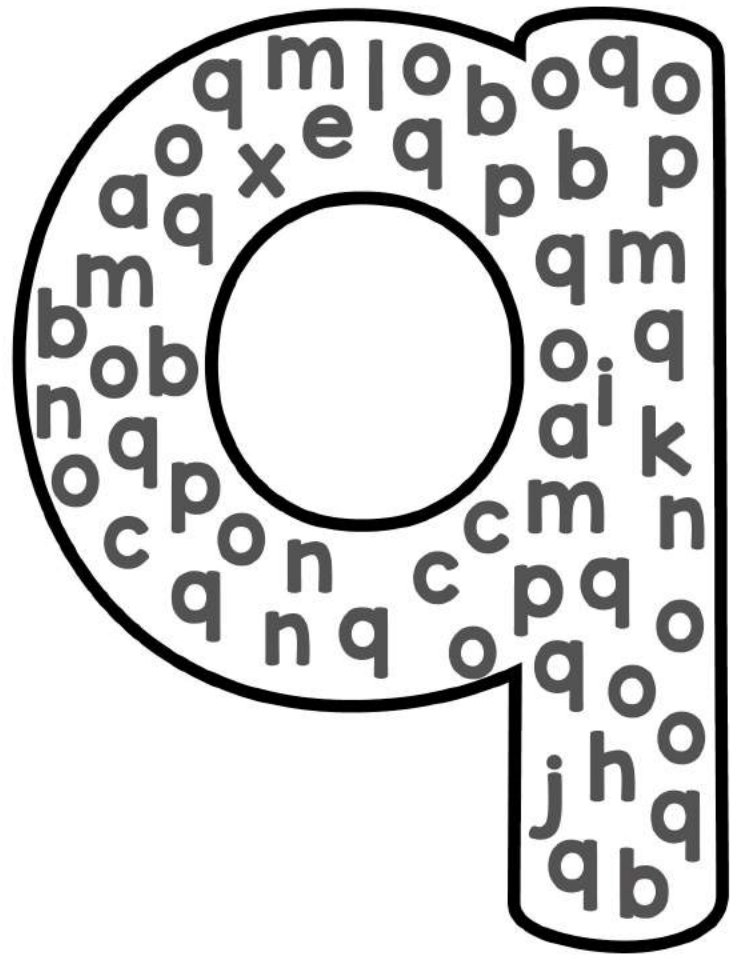
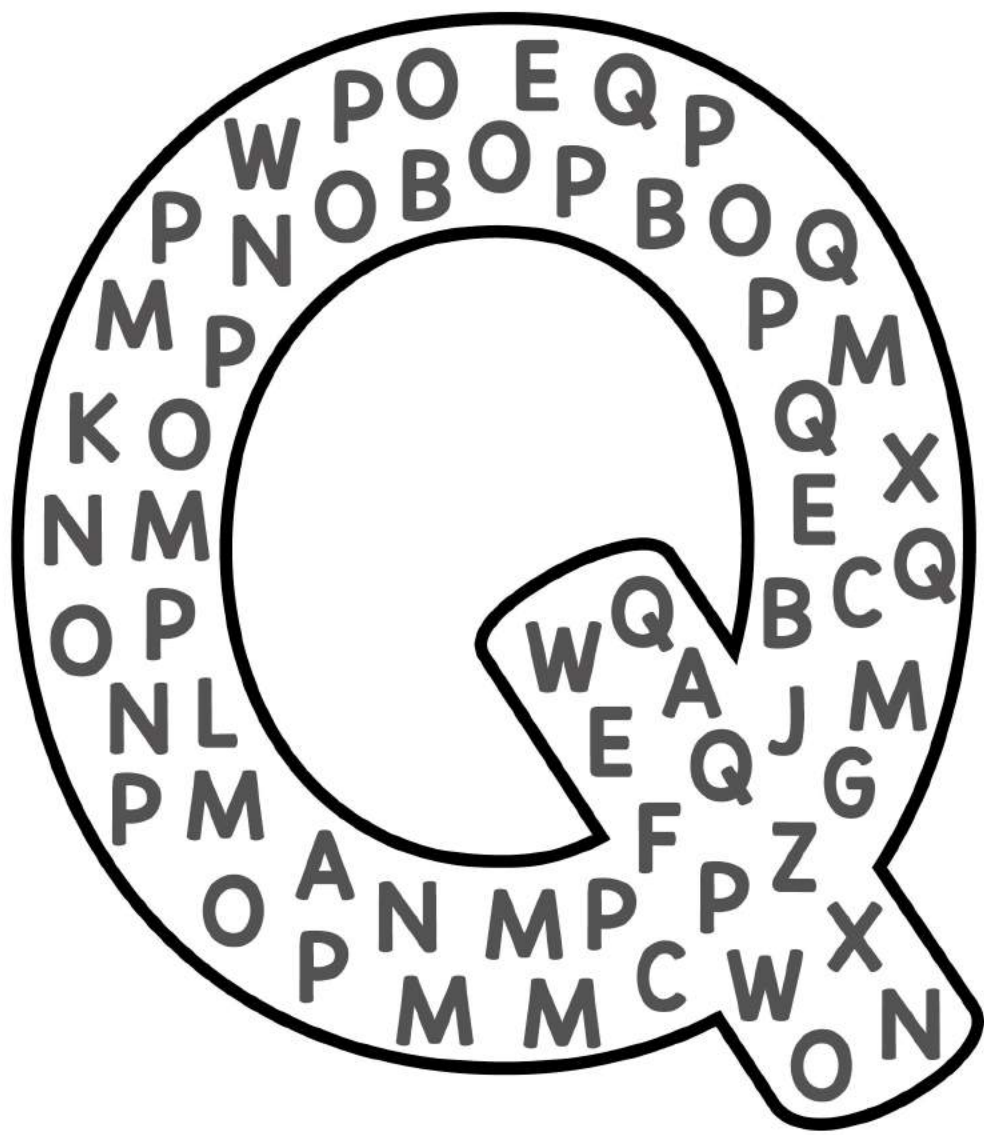

How Many?

How Many?

TRACE

NAME : _____



Color one for each row of letters you complete

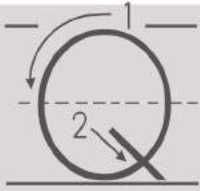

C · O · U · N · T

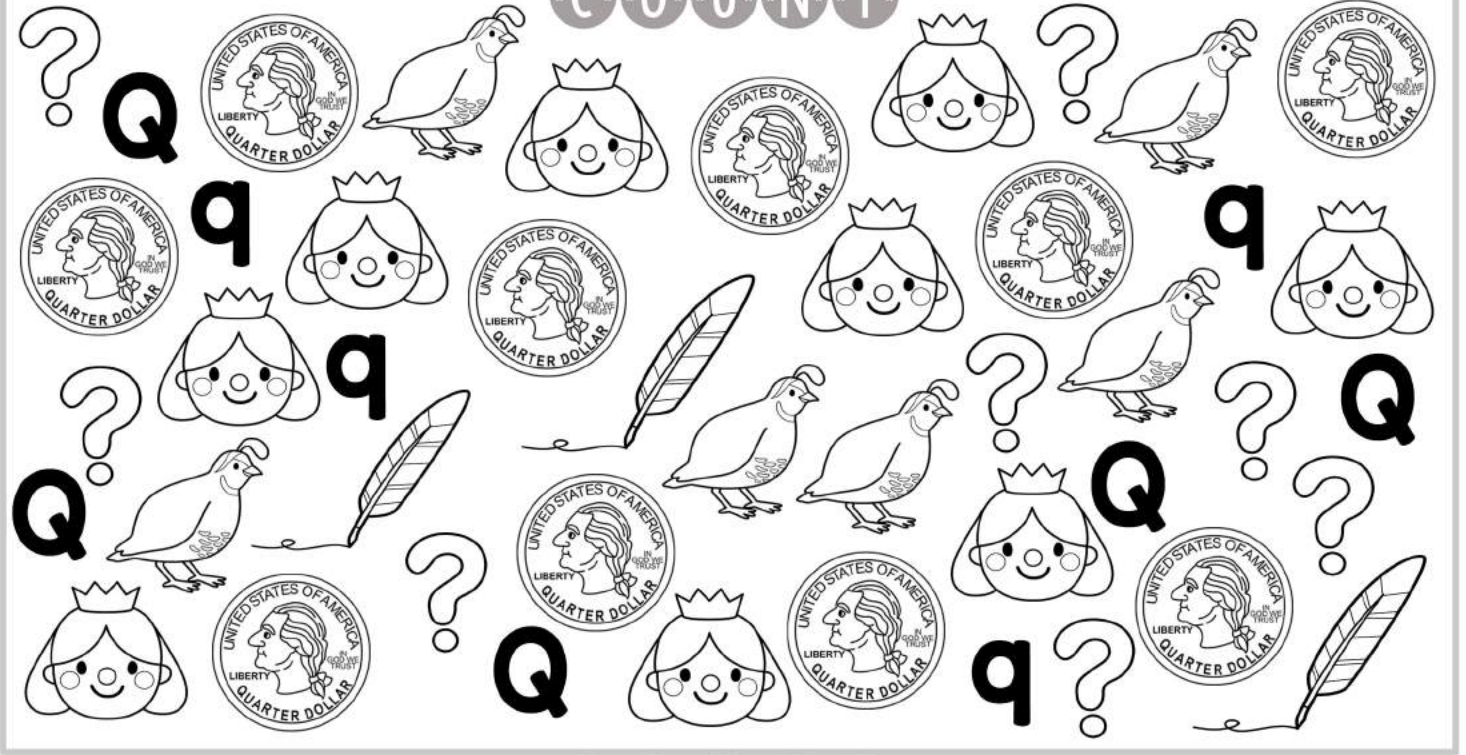

G · R · A · P · H

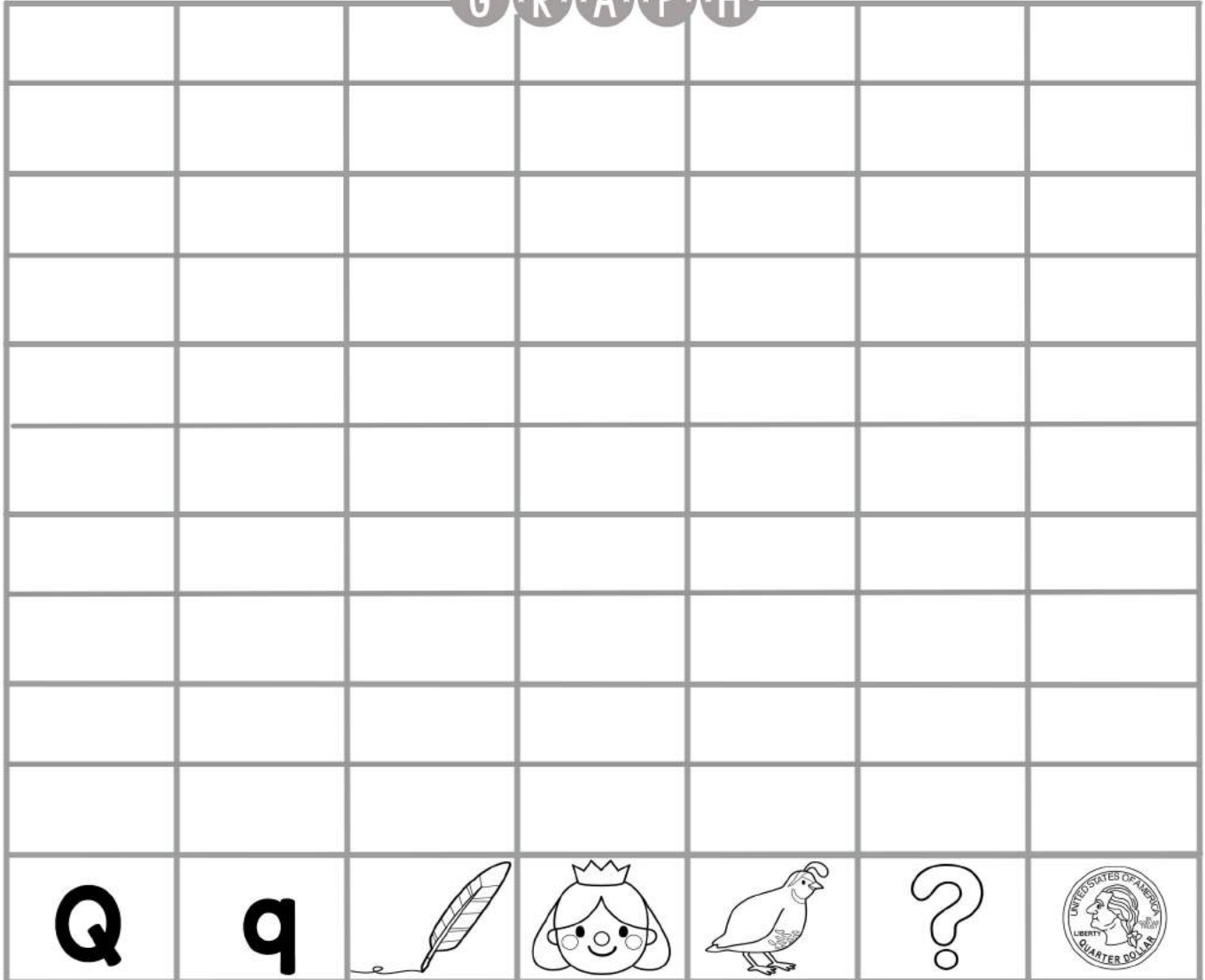



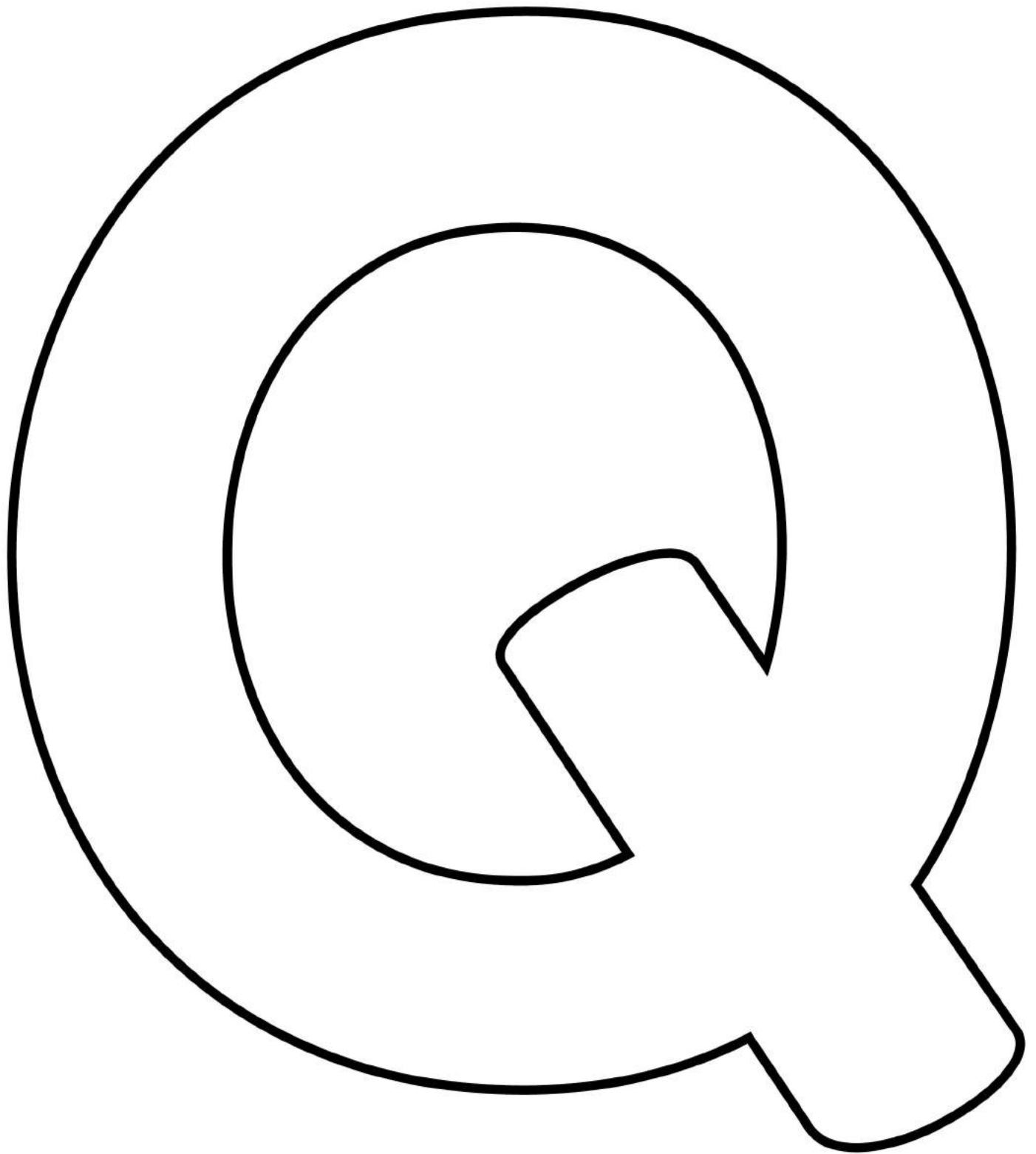



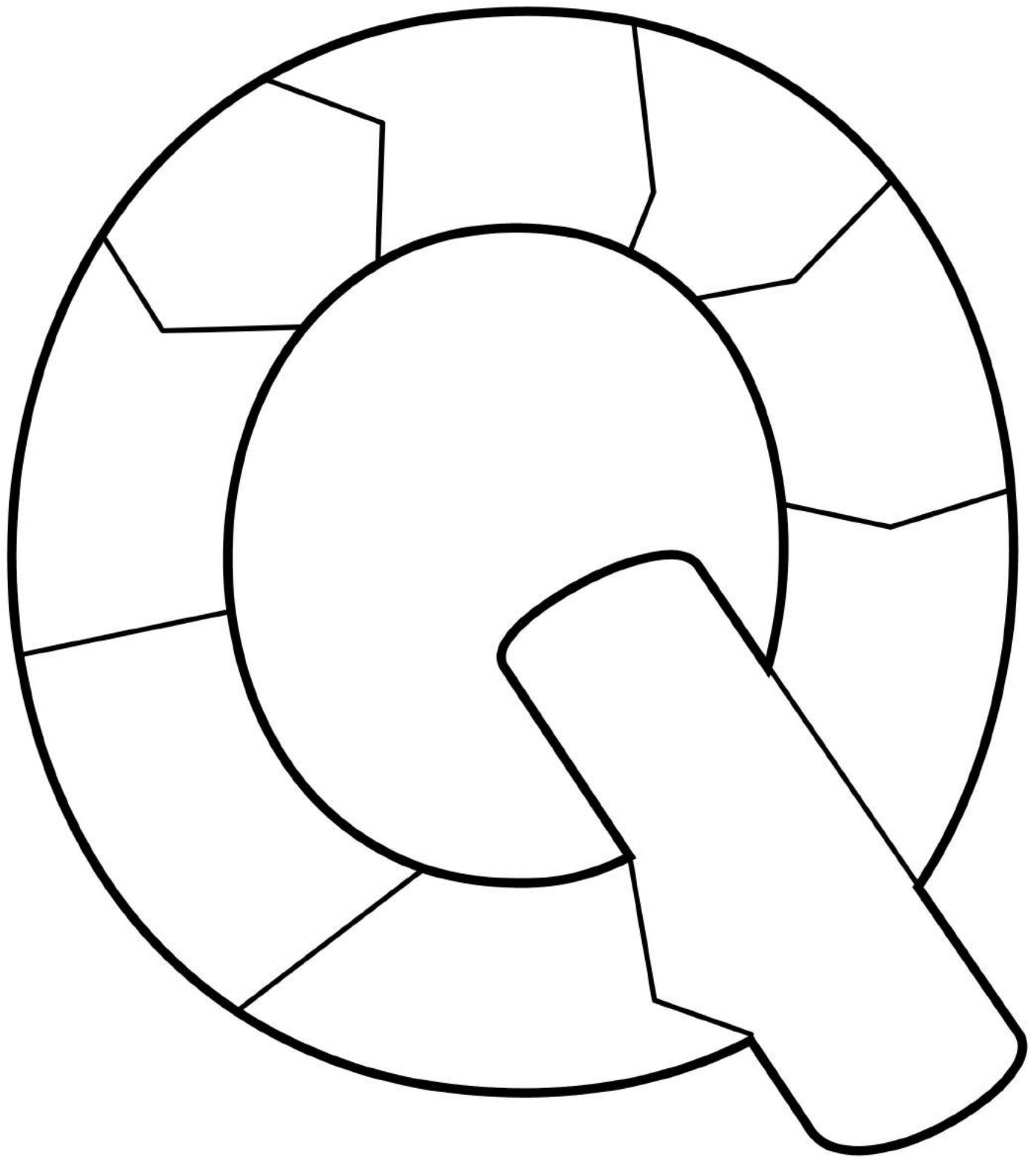

1. Write

2. Cut Out 

NAME : _____

Q Q

Q Q

q q

q q

q q

A B C Q U I L T

3. Color

4. Cut out 

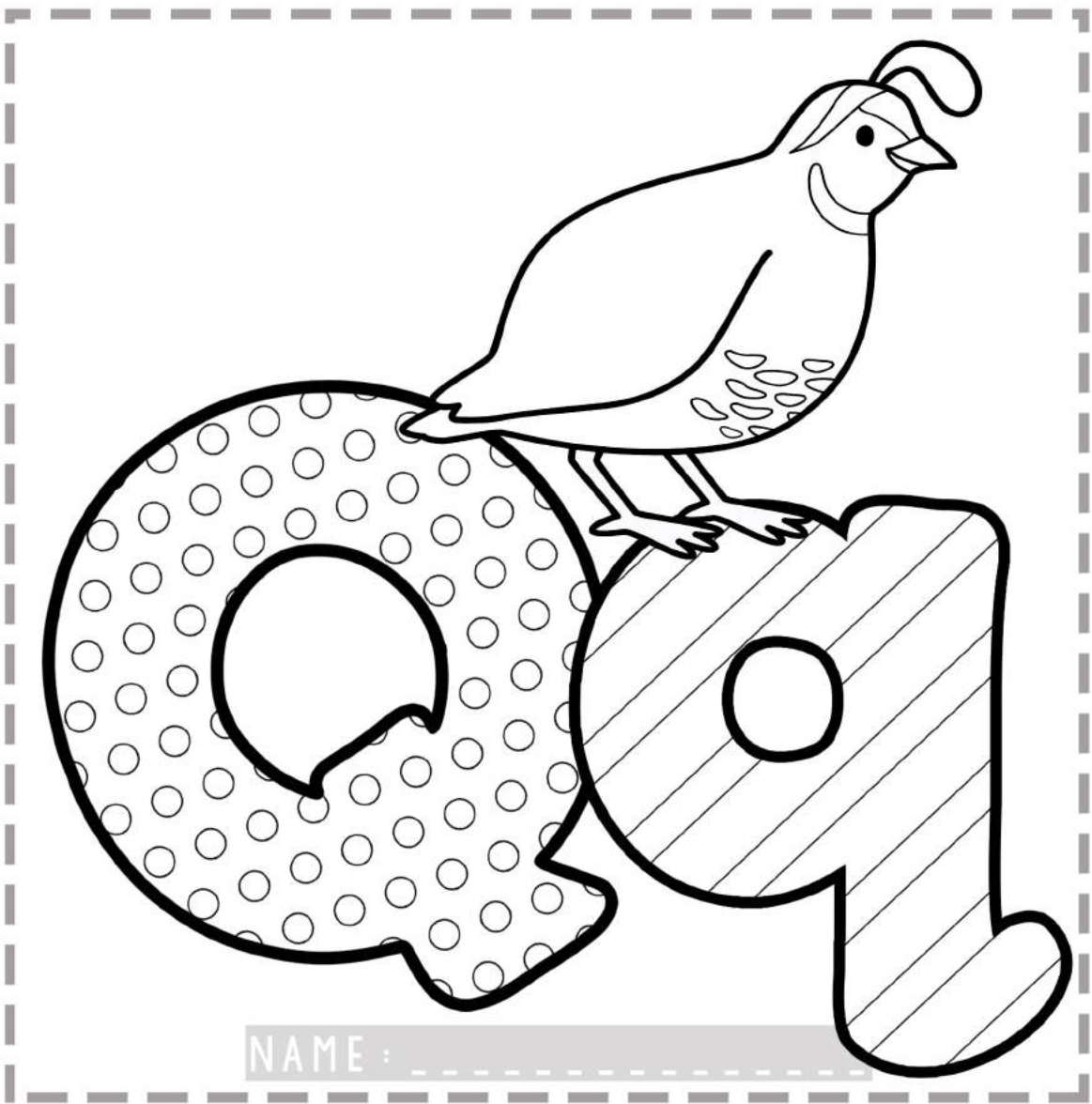

NAME : _____

Qq

Write and read words that begin with letter q,



quiz quiz



quill quill



quail quail



queen queen

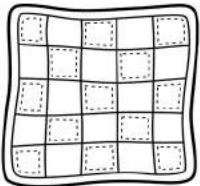

quilt quilt



quarter



question

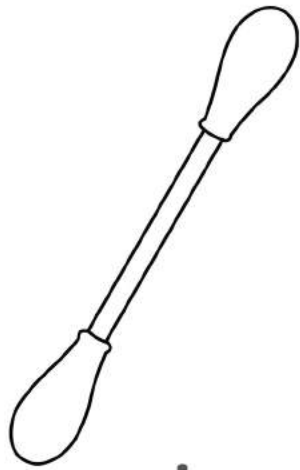

q-tip



queen



quail



quartz



quiz



question

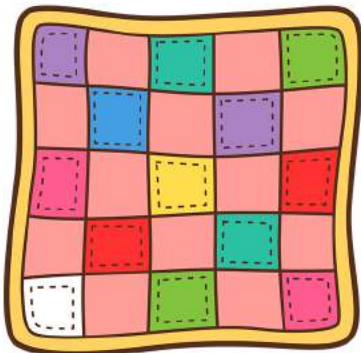

quilt



quill



quarter

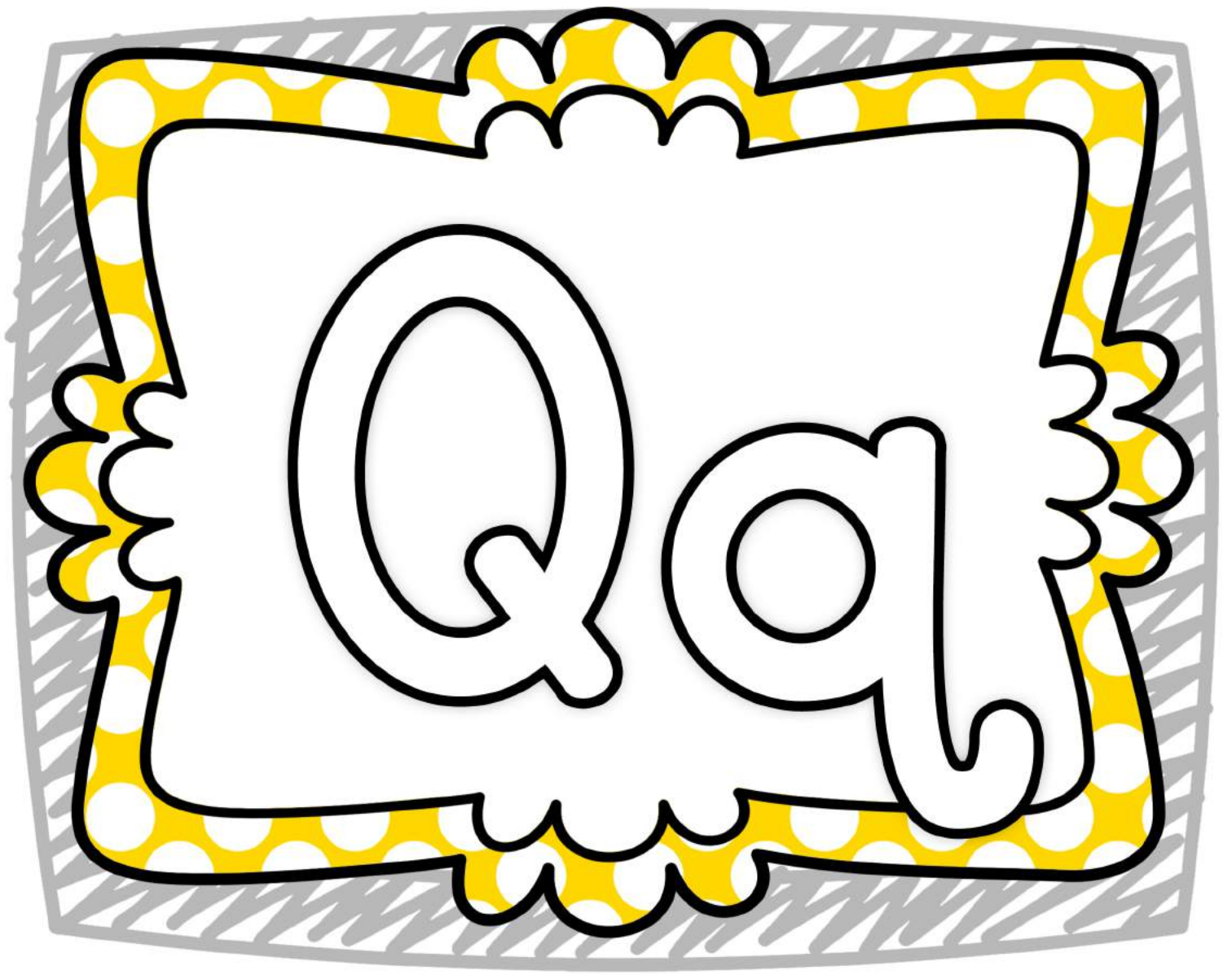

LETTER Q



4 IN A ROW

LETTER Q



4 IN A ROW

LETTER Q



4 IN A ROW

LETTER Q



4 IN A ROW

I CAN WRITE

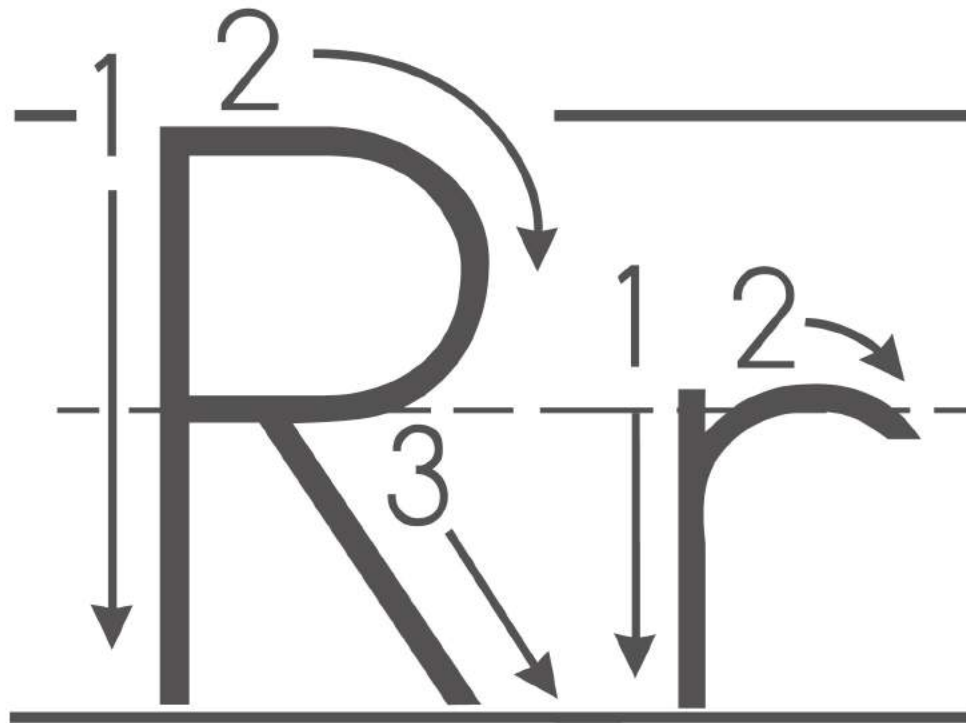

Line Down

Pick up

Big Belly

Pick up

Kick Down

Line Down

Pick up

Little Jump

Robot

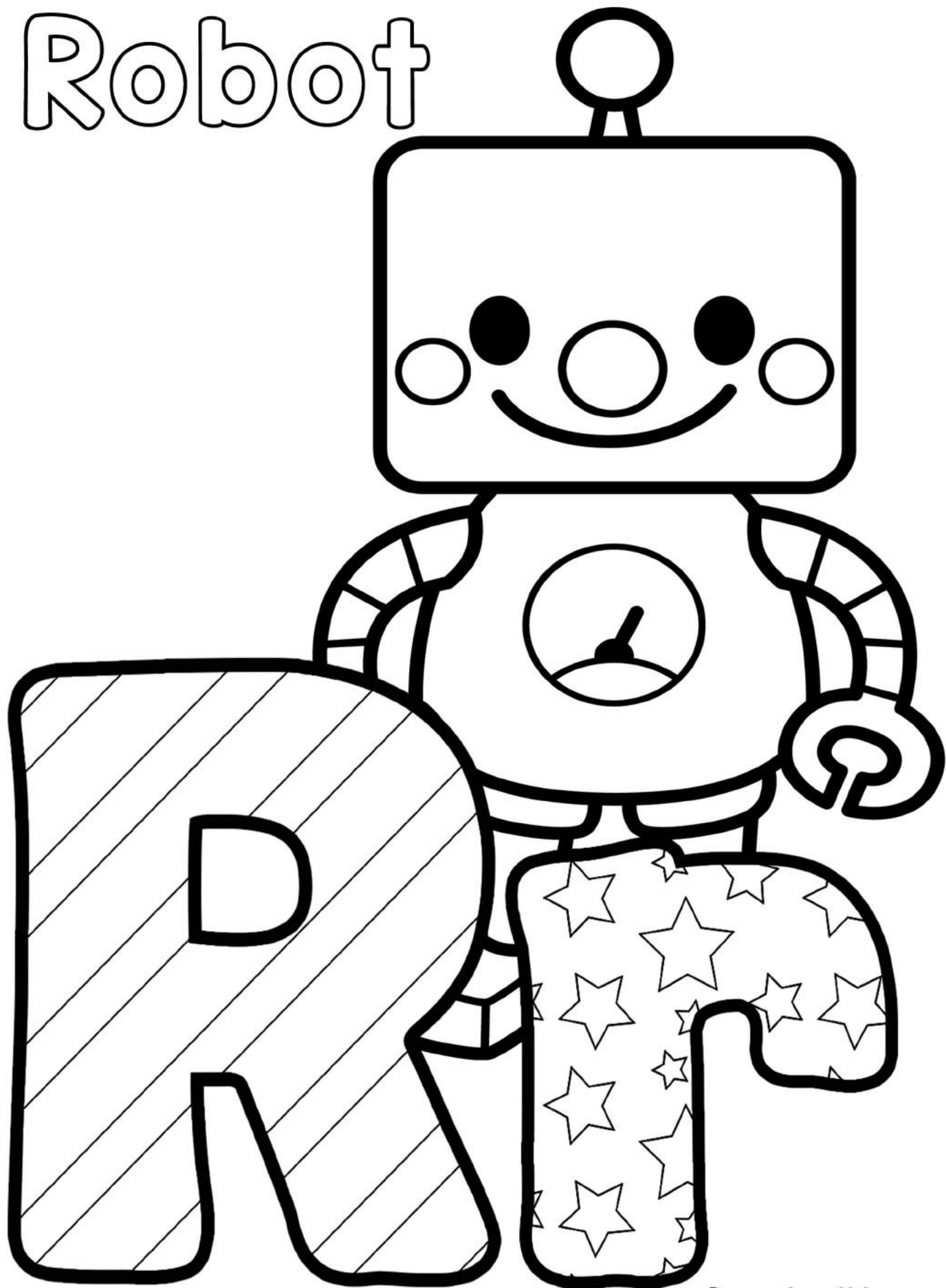

R r

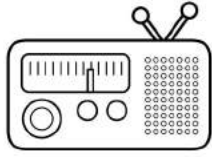
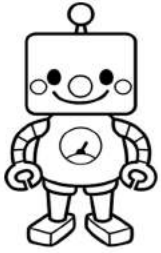
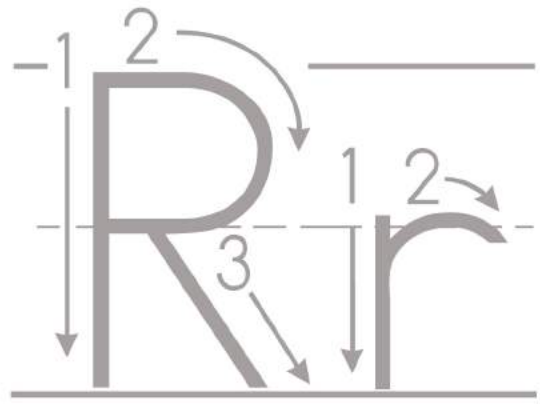

robot

radio

rabbit

rose

rainbow

ring

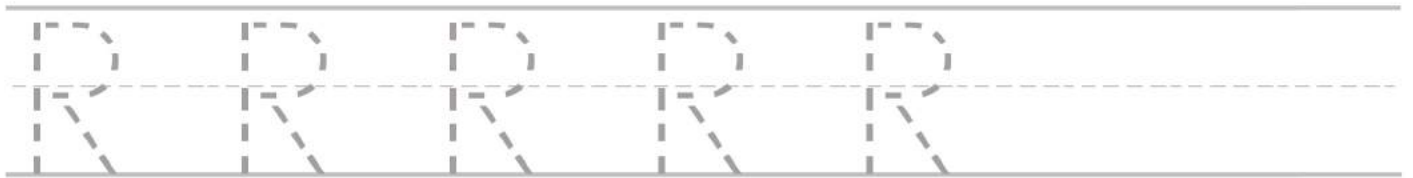
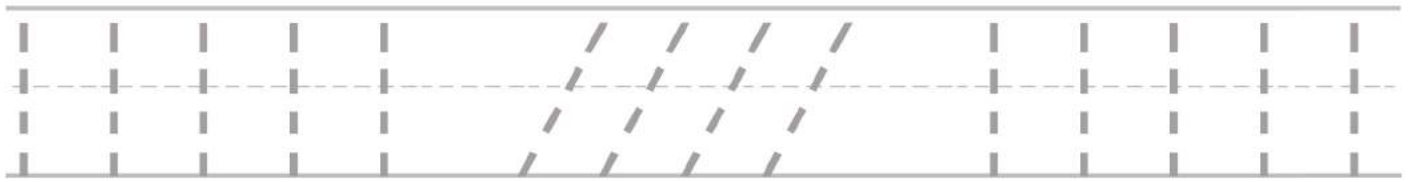

Draw 6 + 2 raindrops



Measure the height and width of the refrigerator

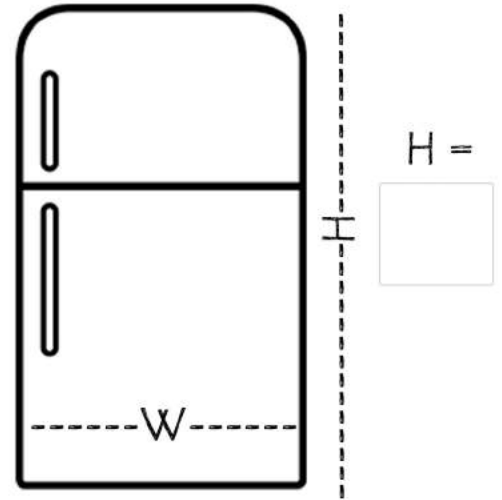

W =

H =

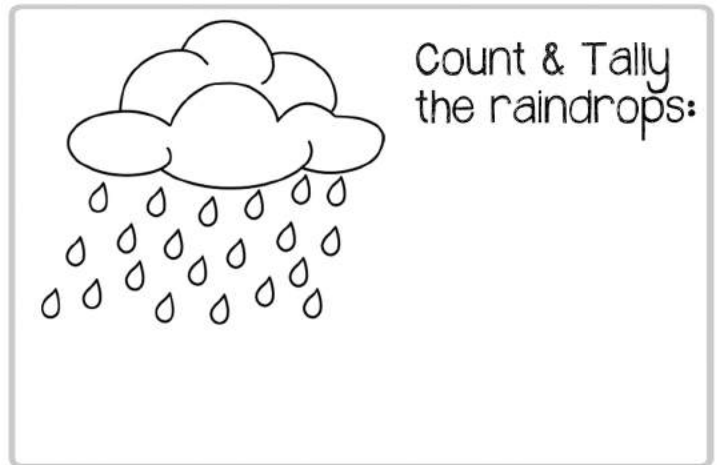
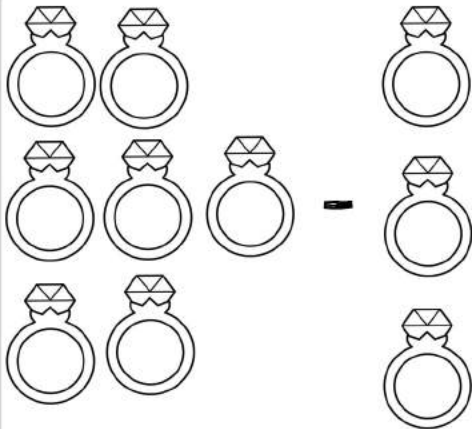

$7 - 2 =$

$7 - 1 =$

$$\begin{array}{r} 7 \\ - 3 \\ \hline \end{array}$$

$$\begin{array}{r} 7 \\ - 4 \\ \hline \end{array}$$

Count the rollerskate wheels by 2



Circle the robots in groups of two. Count by 2's.

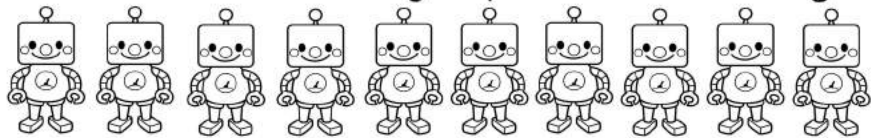

Draw: $7 - 3 = 4$

$7 - 3 = 4$

Rr

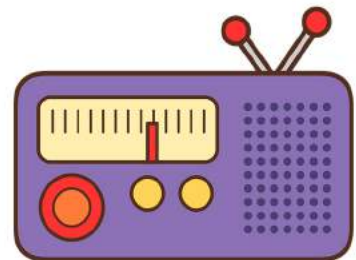
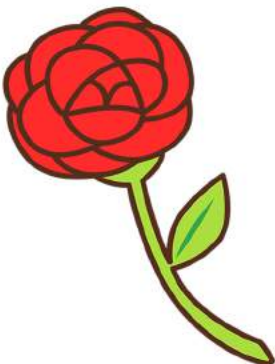
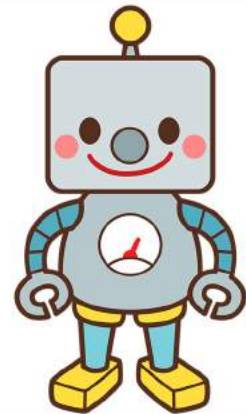
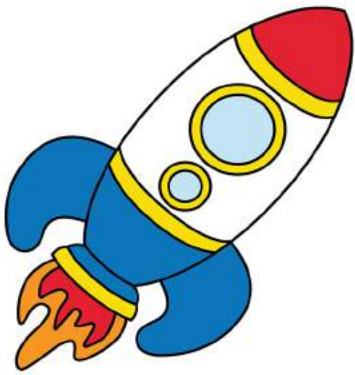
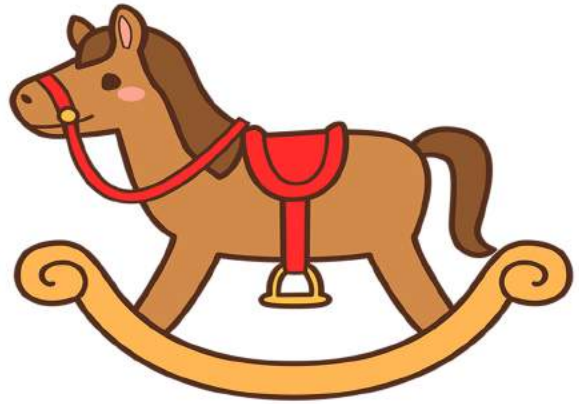

I CAN COLOR

words with:

 = rose

 = roller skates

 = ring

 = radio

 = rain

 = robot

 = rocking horse

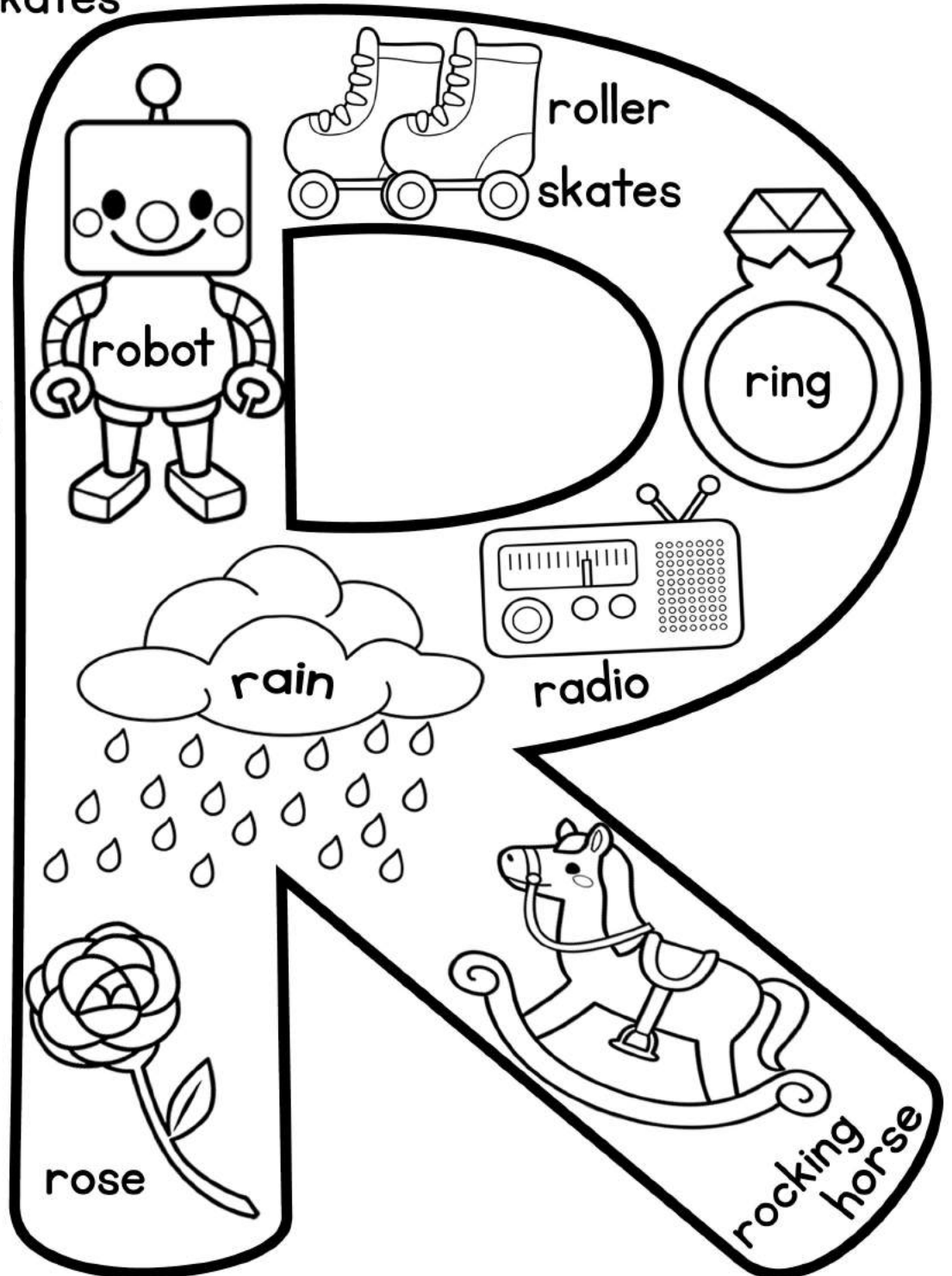

NAME : _____

Rr

Write and read words that begin with letter r.



ring ring ring



rose rose



rain rain rain



rock rock

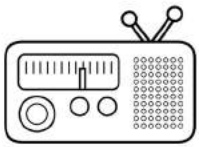

radio radio



rabbit rabbit



rainbow

NAME : _____

Rr

Write and read words that begin with letter r.



Ring Ring



Rose Rose



Rain Rain



Rock Rock

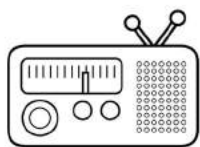

Radio Radio



Rabbit Rabbit



Rainbow

NAME : _____

RACE TO THE TOP

Use a paperclip and a pencil to complete the spinner.

R	r
R	r
R	r
R	r
R	r
R	r
R	r
R	r
R	r
R	r

SPIN



Record

Report:

How many spins landed on R?

How many spins landed on r?

Which had more?

Write an inequality: >

How many spins total?

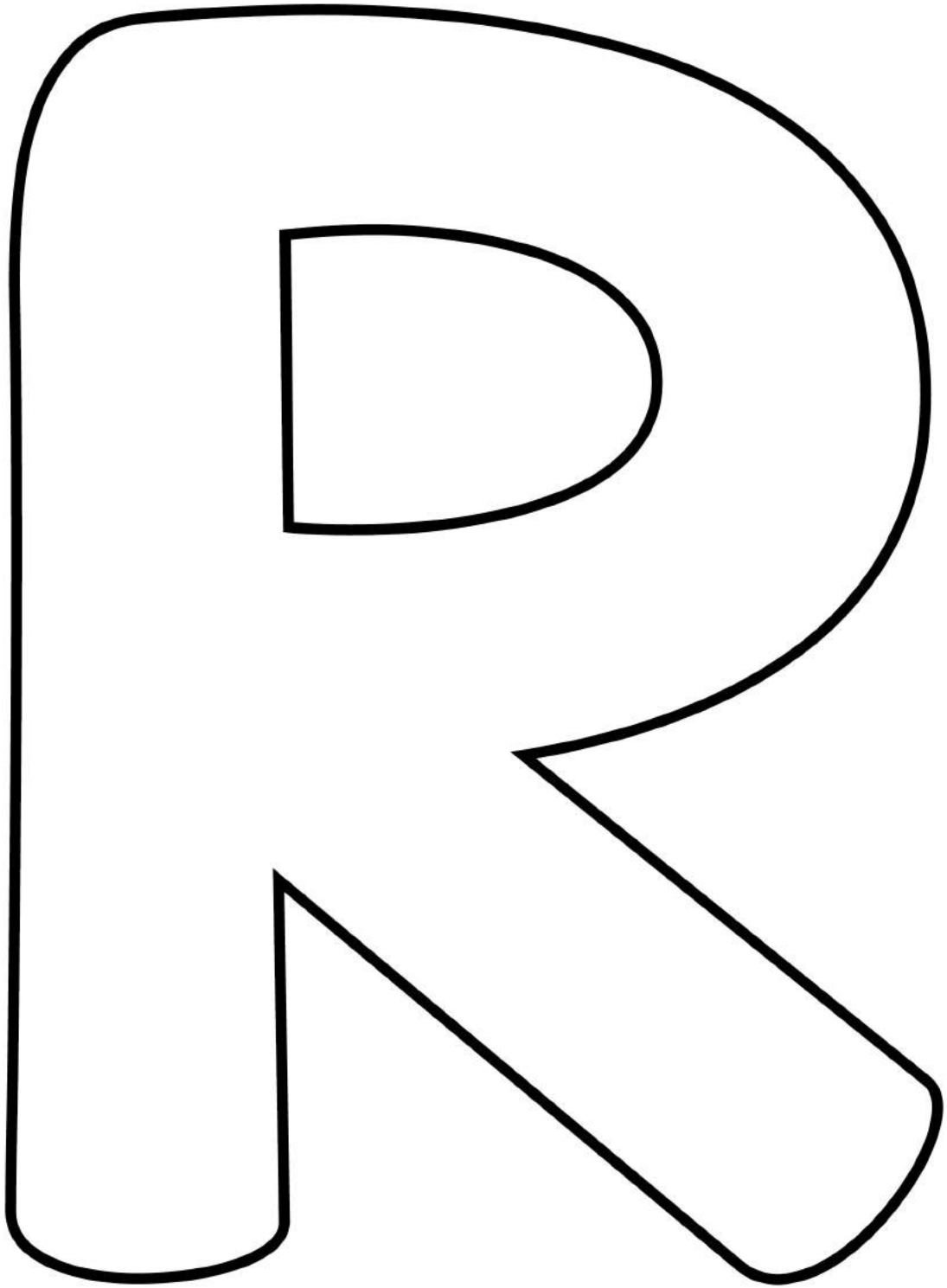

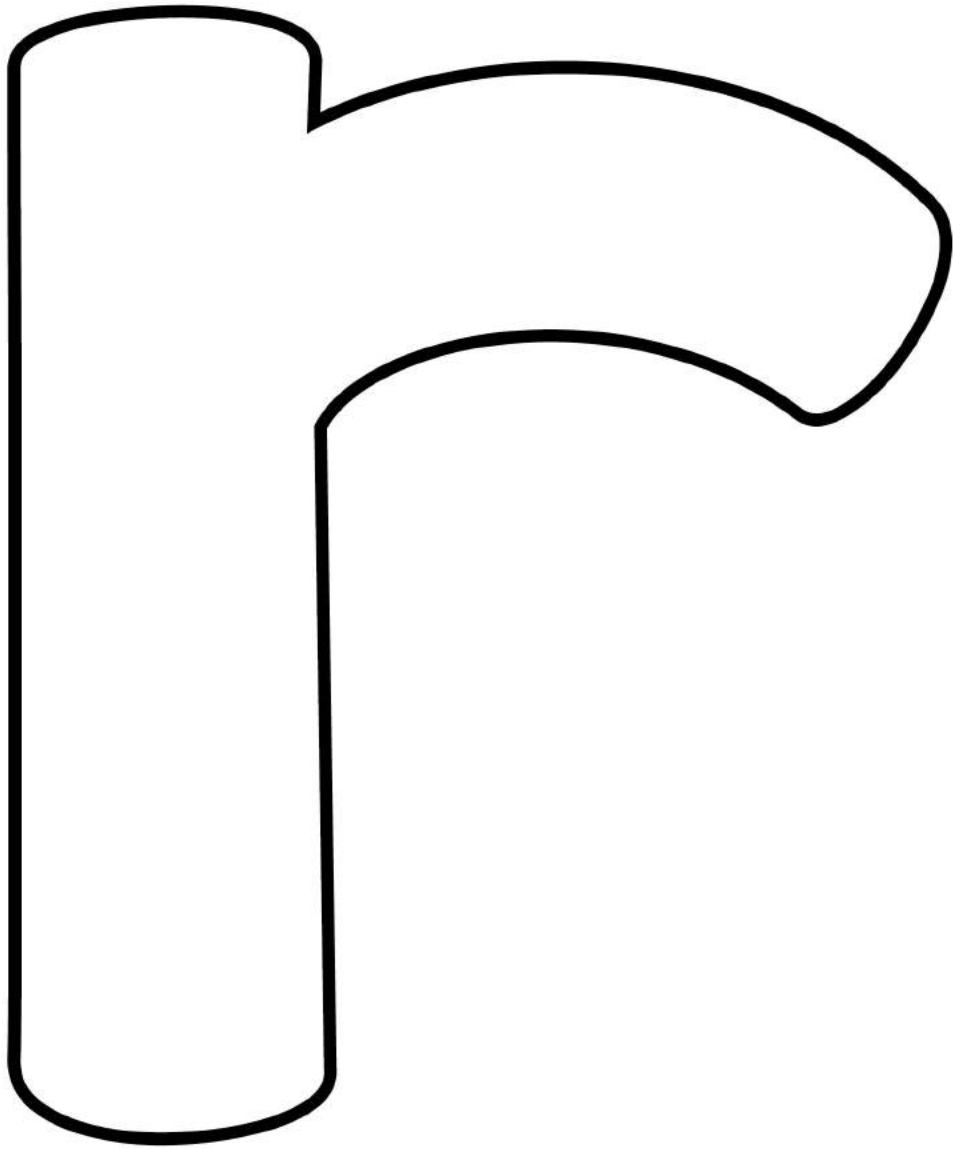



I C A N

F I N D

the letter:

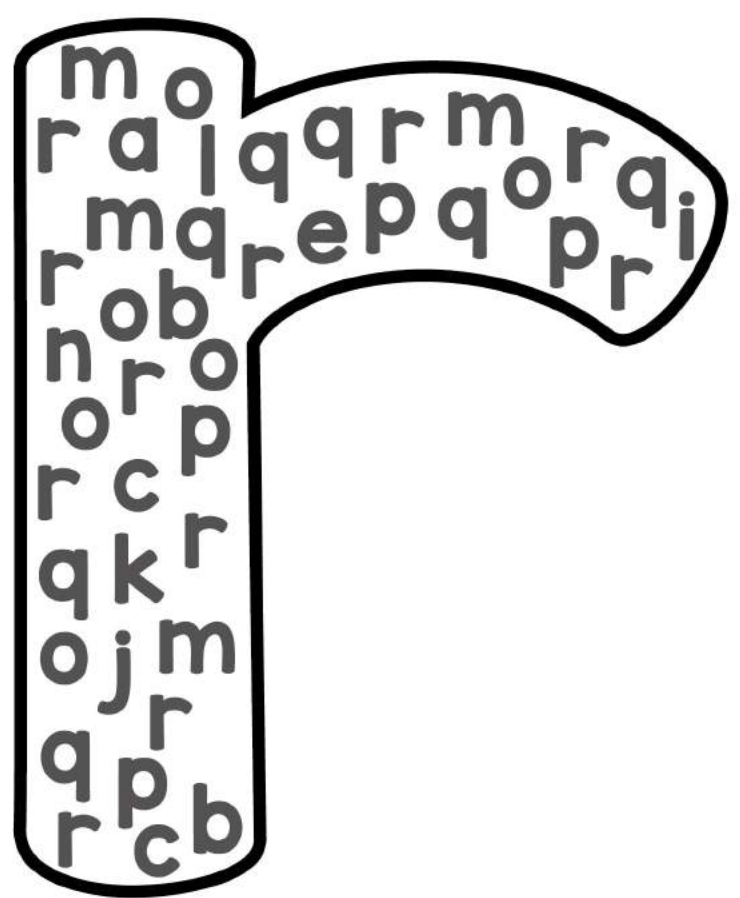
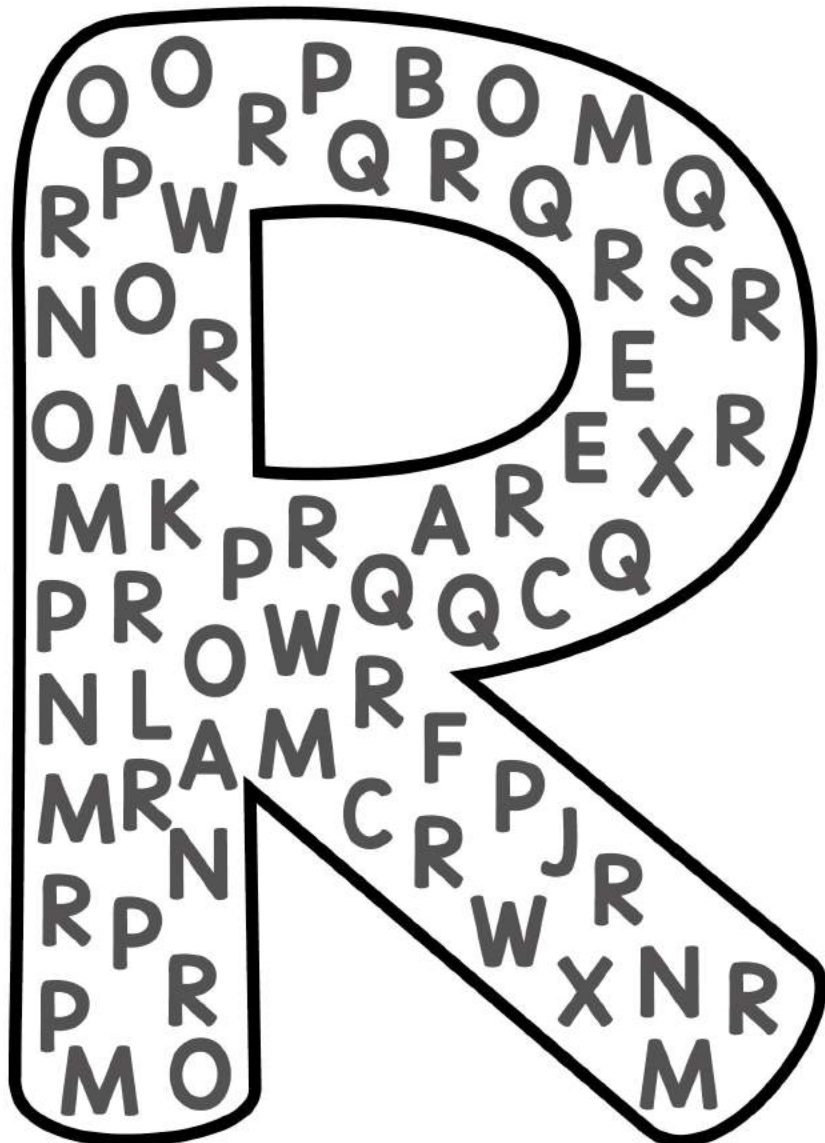

How Many?

How Many?

TRACE

NAME : _____



Color one for each row of letters you complete



R R R R R R R R

R R R R R R R R

R R R R R R R R

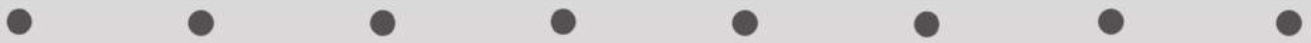

r r r r r r r r

r r r r r r r r

r r r r r r r r



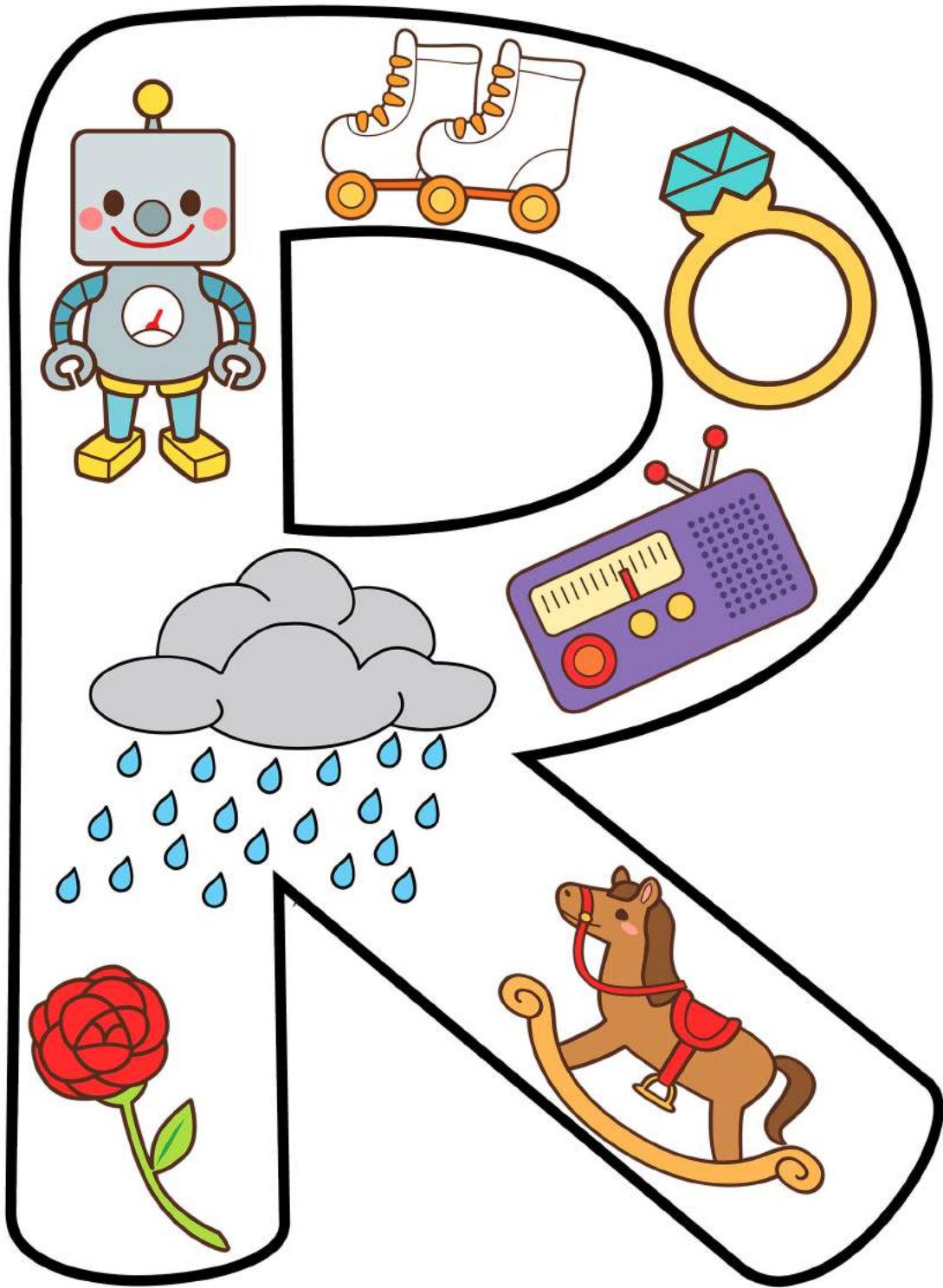

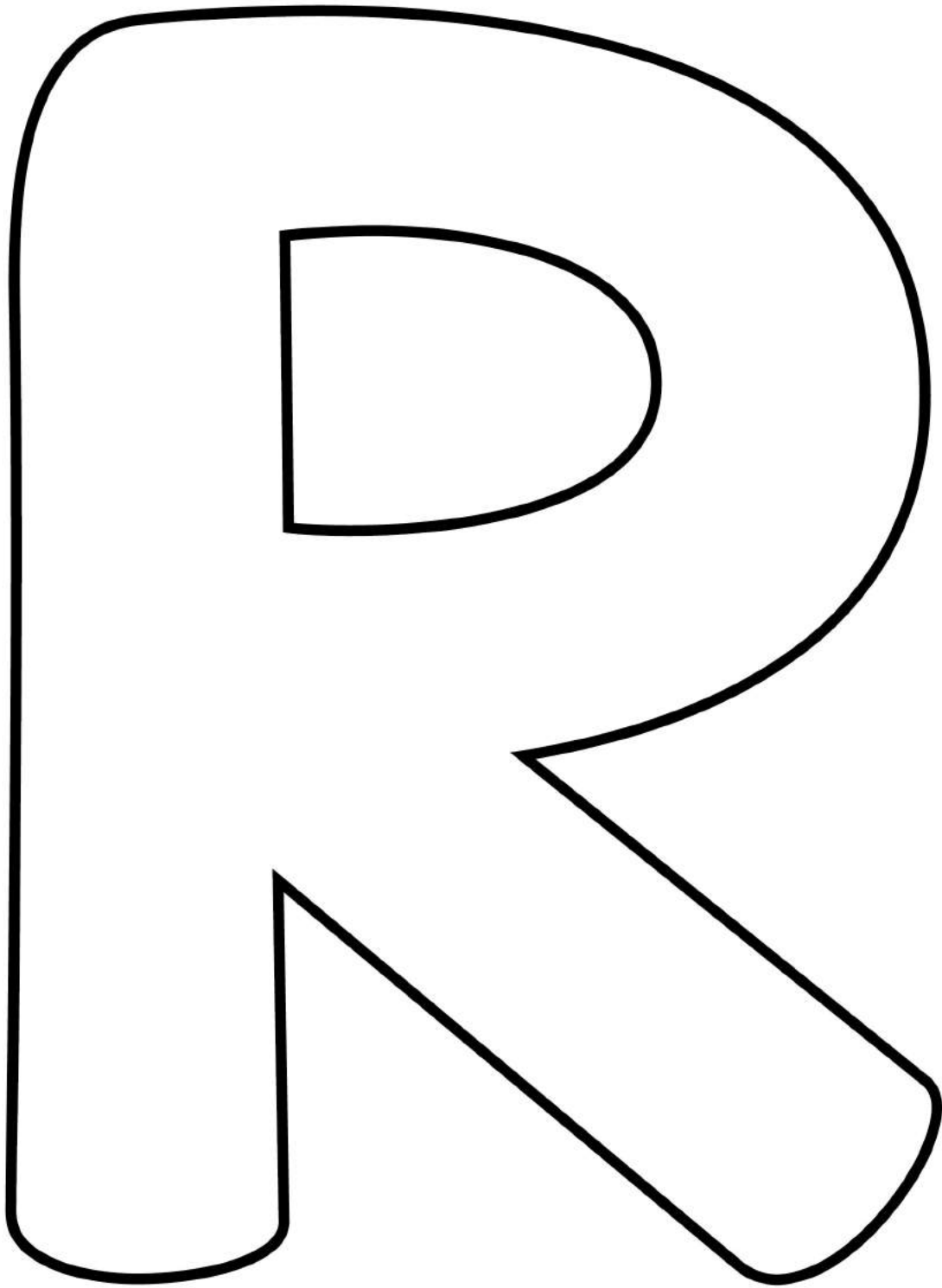

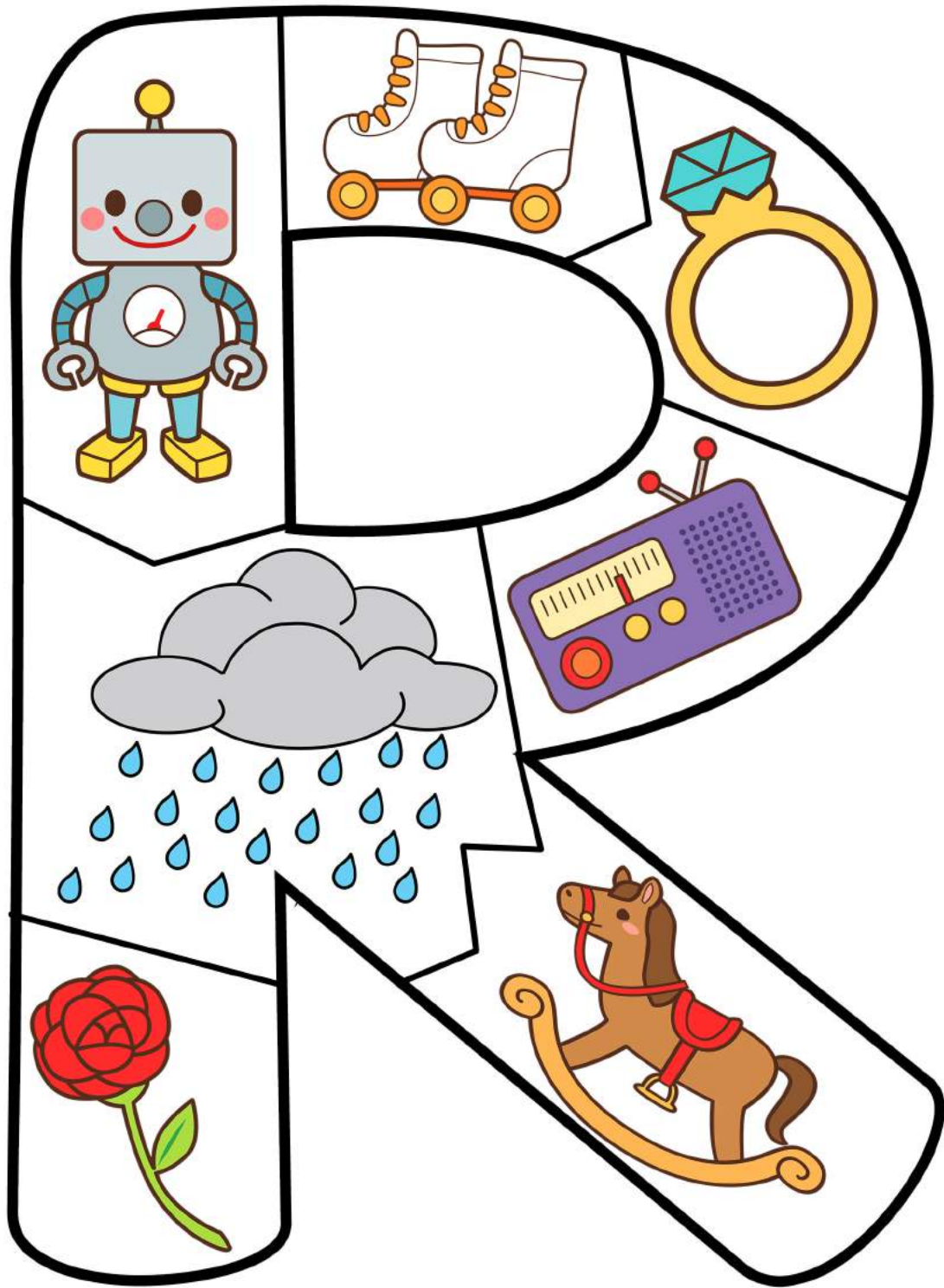

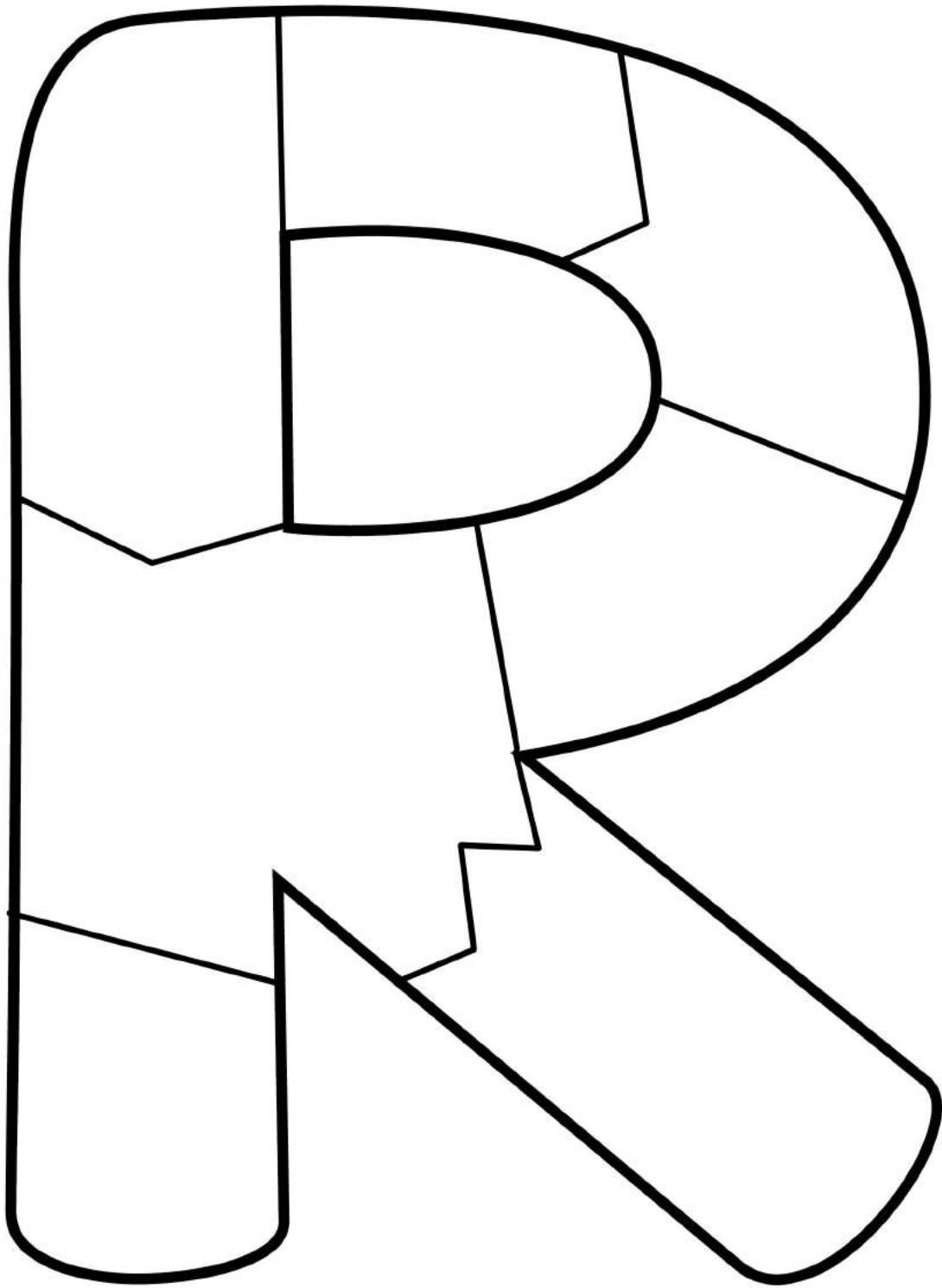

1. Write

2. Cut Out 

A B C Q U I L T

3. Color

4. Cut out 

NAME : _____

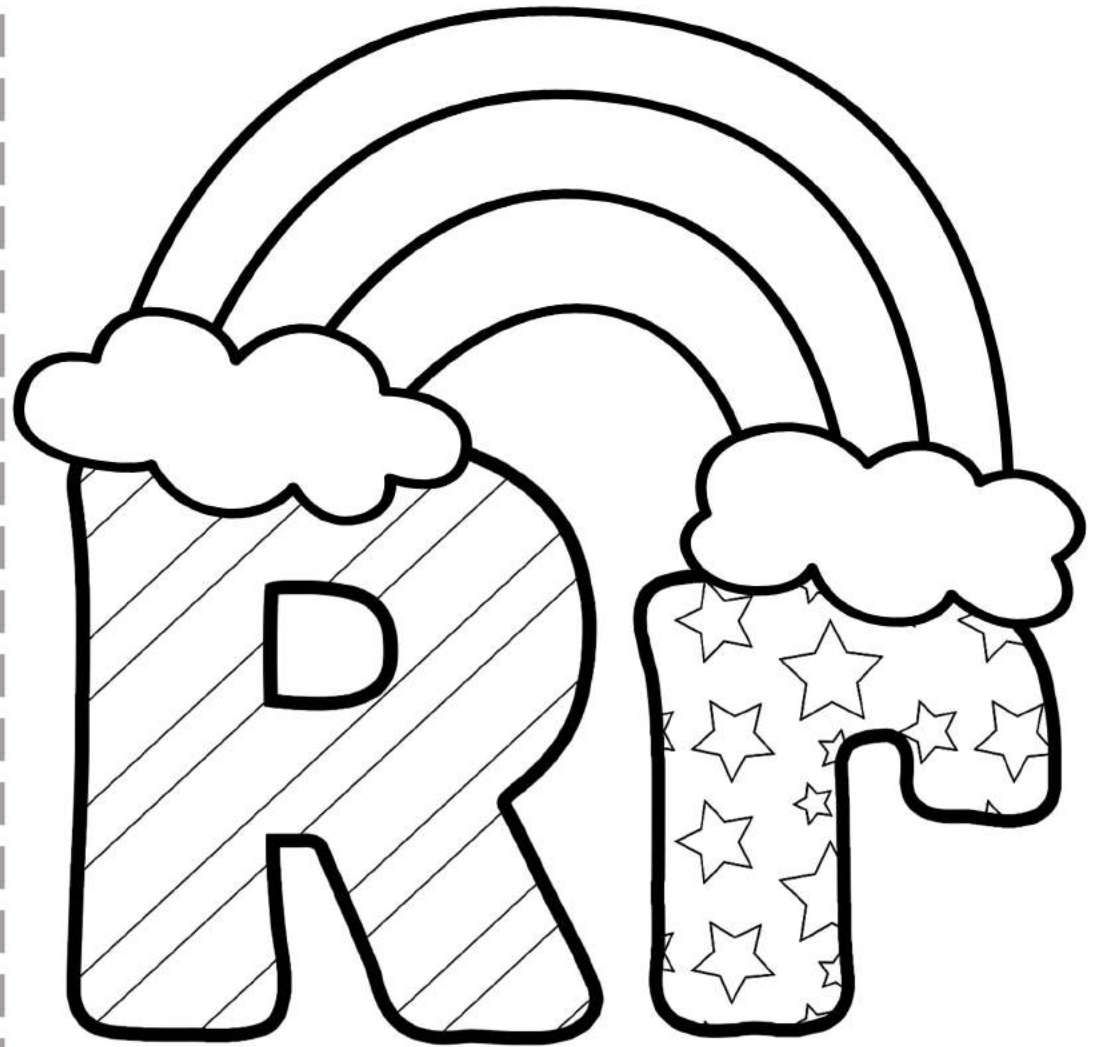
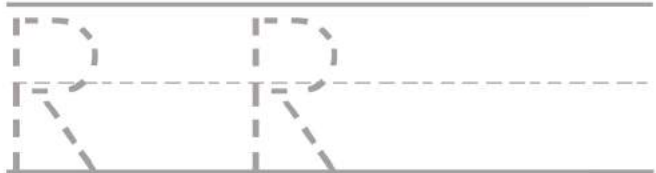

NAME : _____

NAME : _____

Rr

Write and read words that begin with letter r.



ring ring ring



rose rose



rain rain rain



rock rock

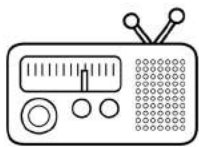

radio radio



rabbit rabbit



rainbow

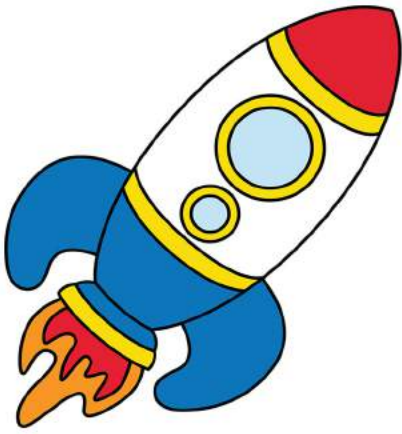

rocket



rabbit



ring

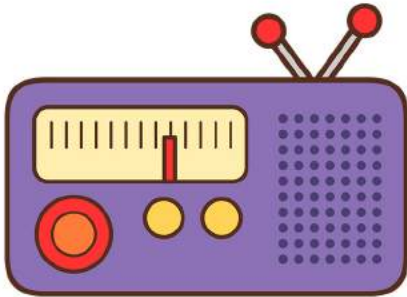

radio

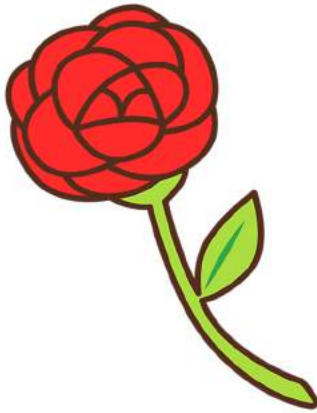

rose



rain

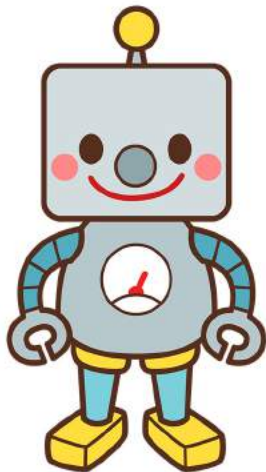

robot



rainbow





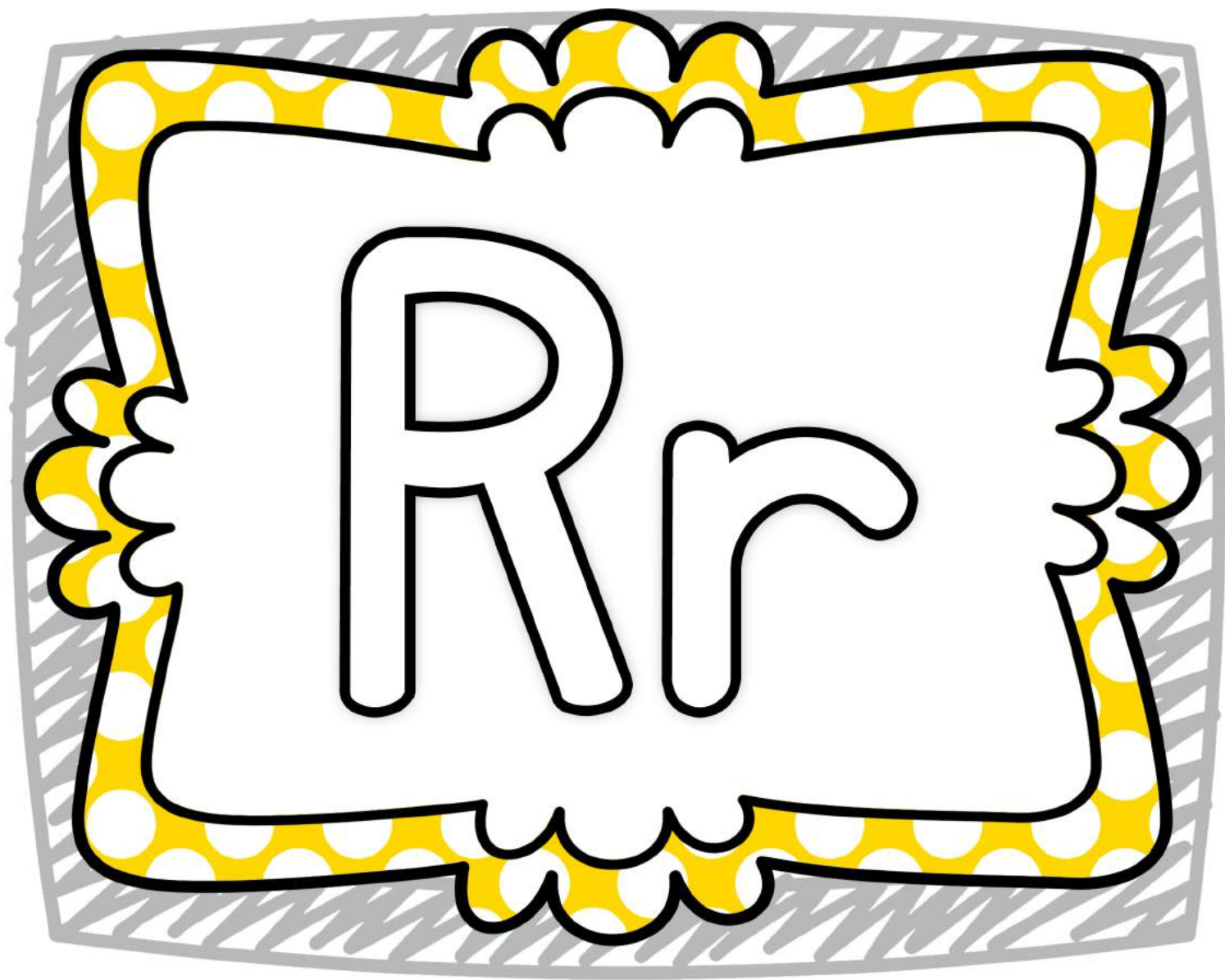









roller skate



LETTER R



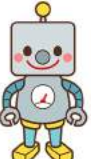
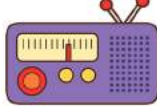









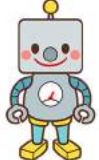

4 IN A ROW

R			
			
			r
			

LETTER R



4 IN A ROW











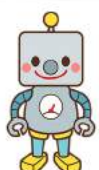





	r		
			
			
			R

Images (c) Little Red's Clipart, Zip-a-De-Doo-Dah Designs & Miss Giraffe

LETTER R

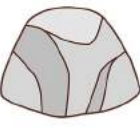

















4 IN A ROW

LETTER R

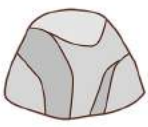

4 IN A ROW

Images (c) Little Red's Clipart, Zip-a-De-Doo-Dah Designs & Miss Giraffe

I C A N W R I T E



Slither Back
Slither Front

Slither Back
Slither Front

Spider

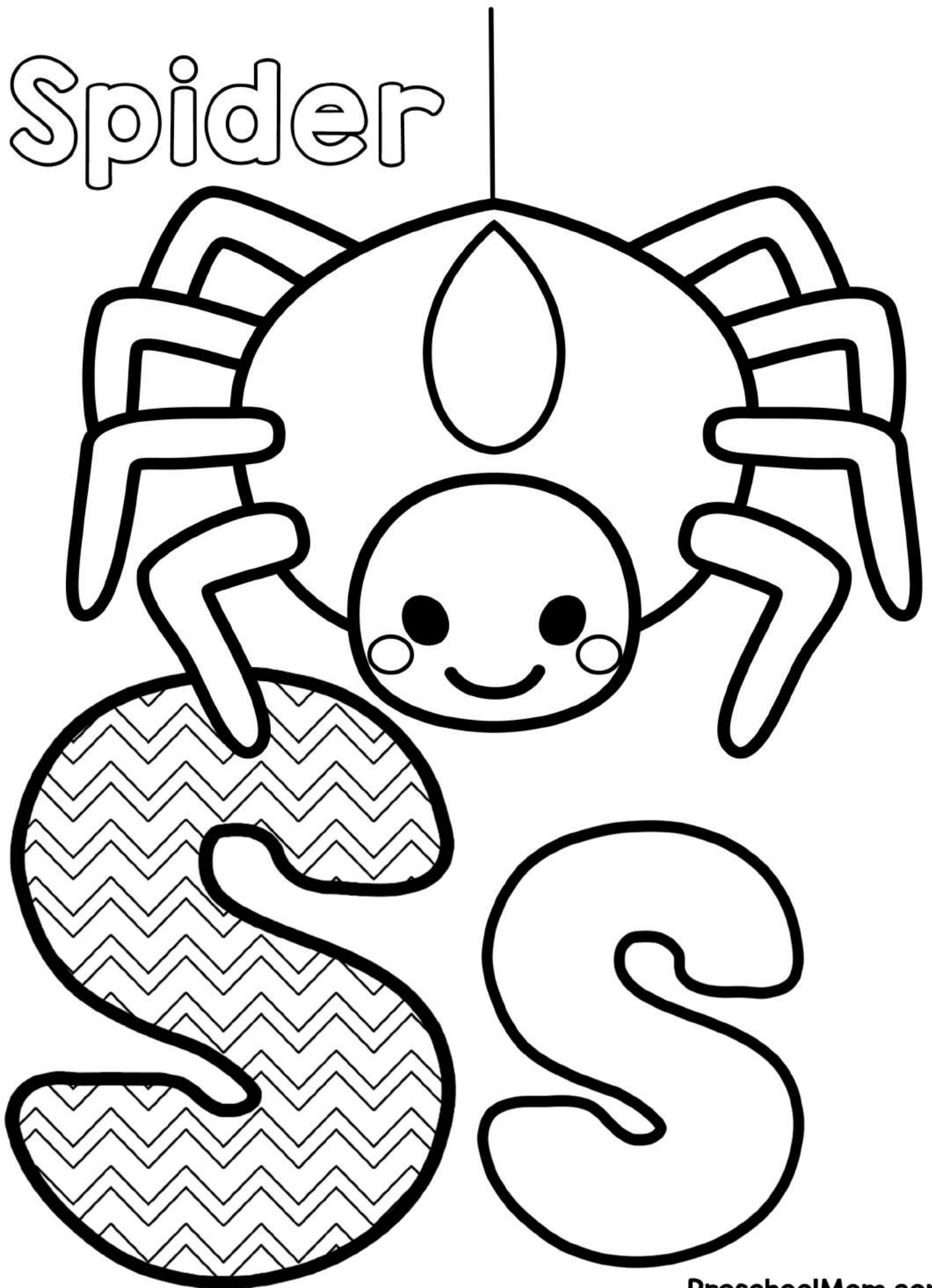

S s

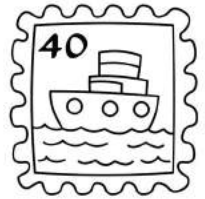
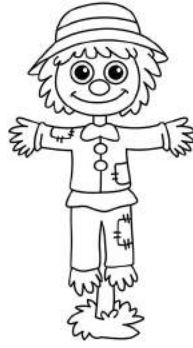

snail

sword

scarecrow

sock

snowman

stamp

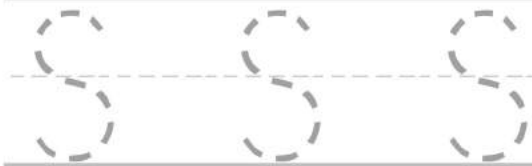
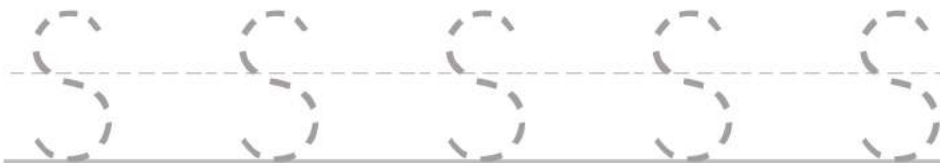
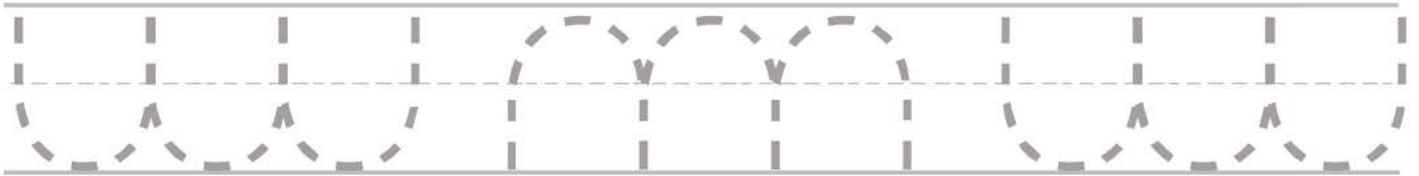

Draw 15 rays around the sun:

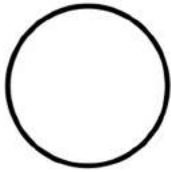

Circle the correct amount of money for the stamp:

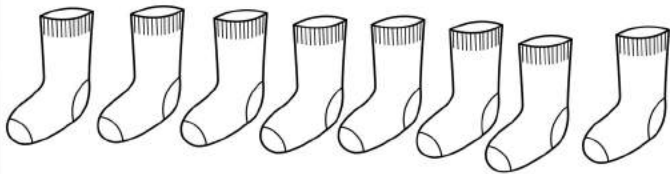
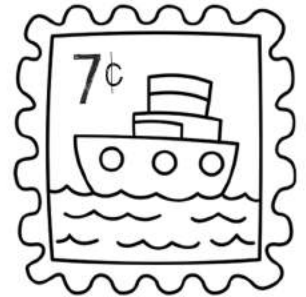
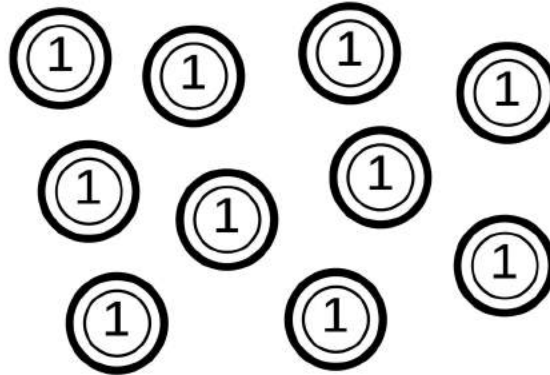

-

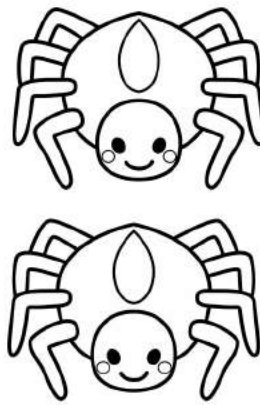
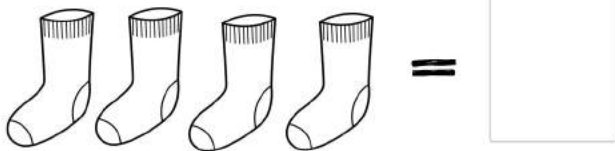

Count & Tally the spiders legs:

$$8 - 2 = \square$$

$$8 - 3 = \square$$

$$\begin{array}{r} 8 \\ - 1 \\ \hline \square \end{array}$$

$$\begin{array}{r} 8 \\ - 4 \\ \hline \square \end{array}$$

Circle what comes next:



Circle the swords in groups of two. Count by 2's

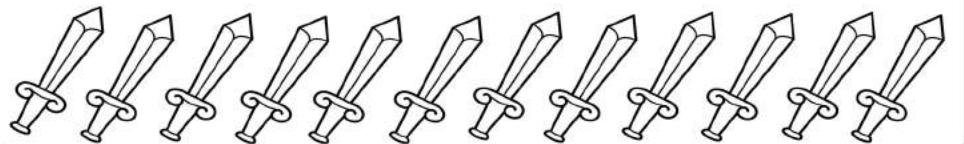

Draw: $8 - 3 = 3$

- =

Ss



I CAN COLOR

words with:

-  = shoe
-  = scarecrow
-  = snail
-  = sword
-  = spider
-  = snowman
-  = shoe

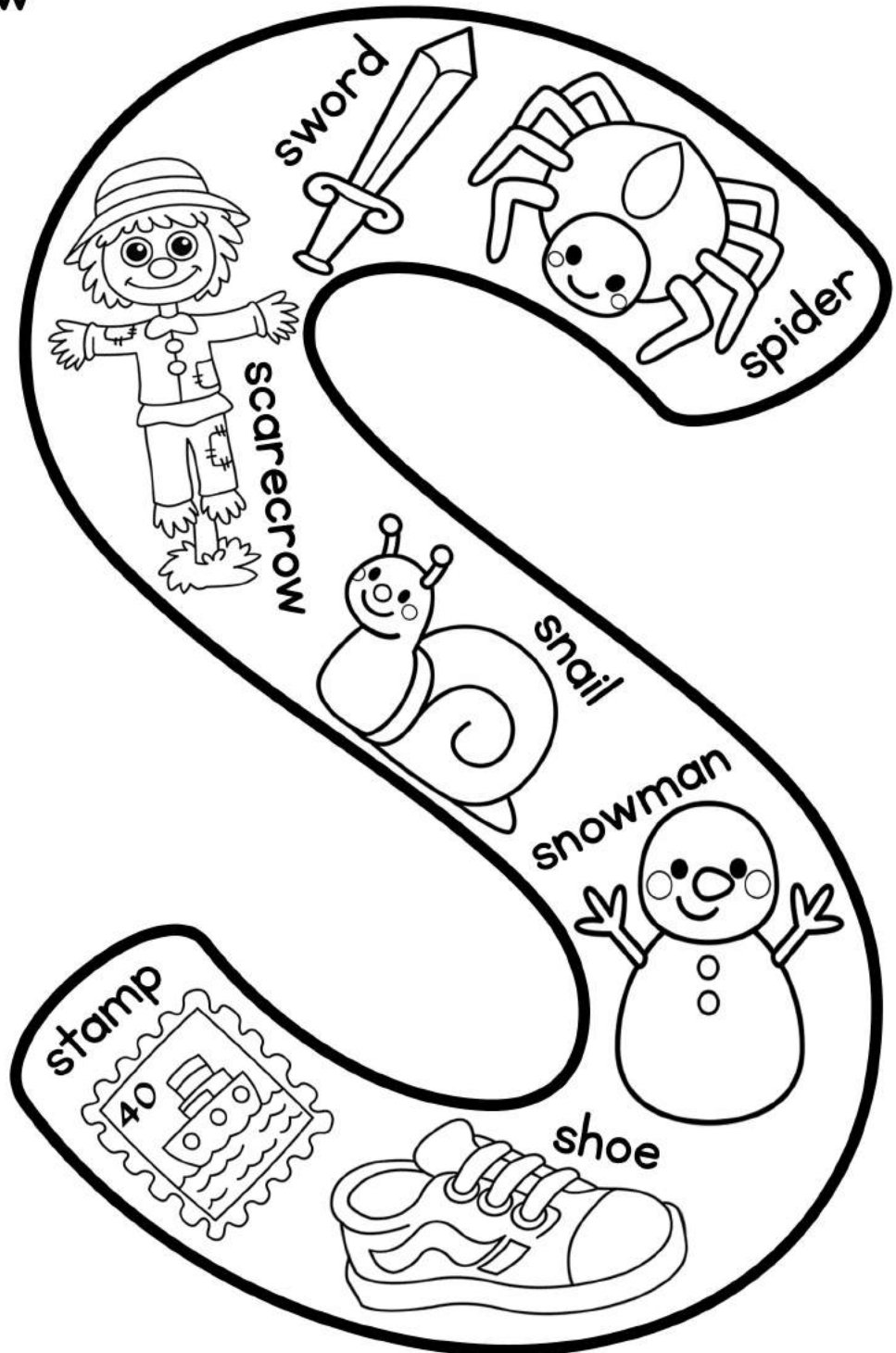

NAME : _____

Ss

Write and read words that begin with letter s.

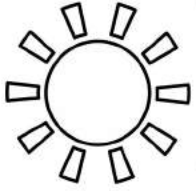

sun sun sun



sock sock



soap soap



shoe shoe



snail snail

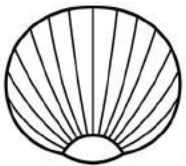

shell shell



sword sword

NAME : _____

Ss

Write and read words that begin with letter s.

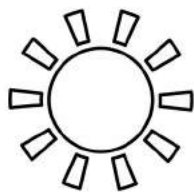

Sun Sun Sun



Sock Sock



Soap Soap



Shoe Shoe



Snail Snail

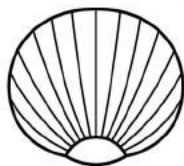

Shell Shell



Sword Sword

NAME : _____

RACE TO THE TOP

Use a paperclip and a pencil to complete the spinner.

S	s
S	s
S	s
S	s
S	s
S	s
S	s
S	s
S	s
S	s

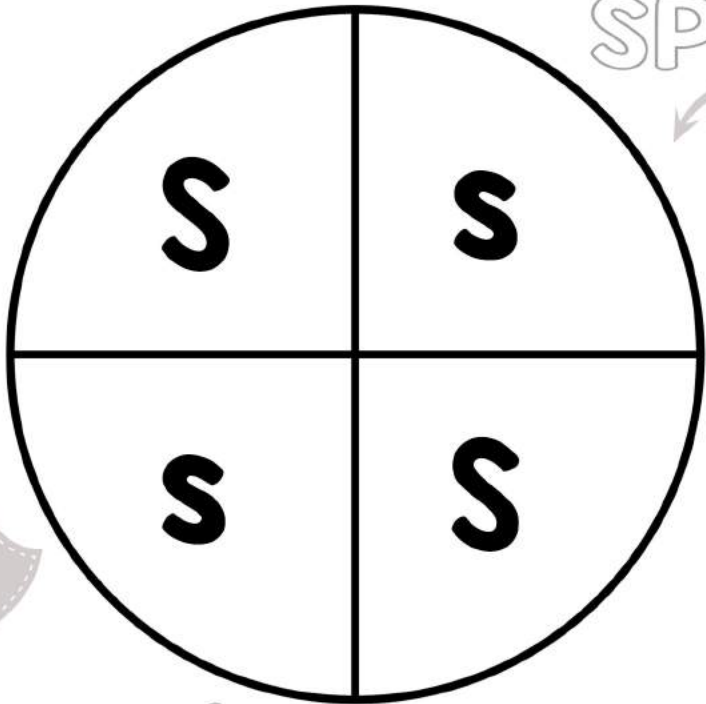

SPIN

Record

Report:

How many spins landed on S?

How many spins landed on s?

Which had more?

Write an inequality: >

How many spins total?

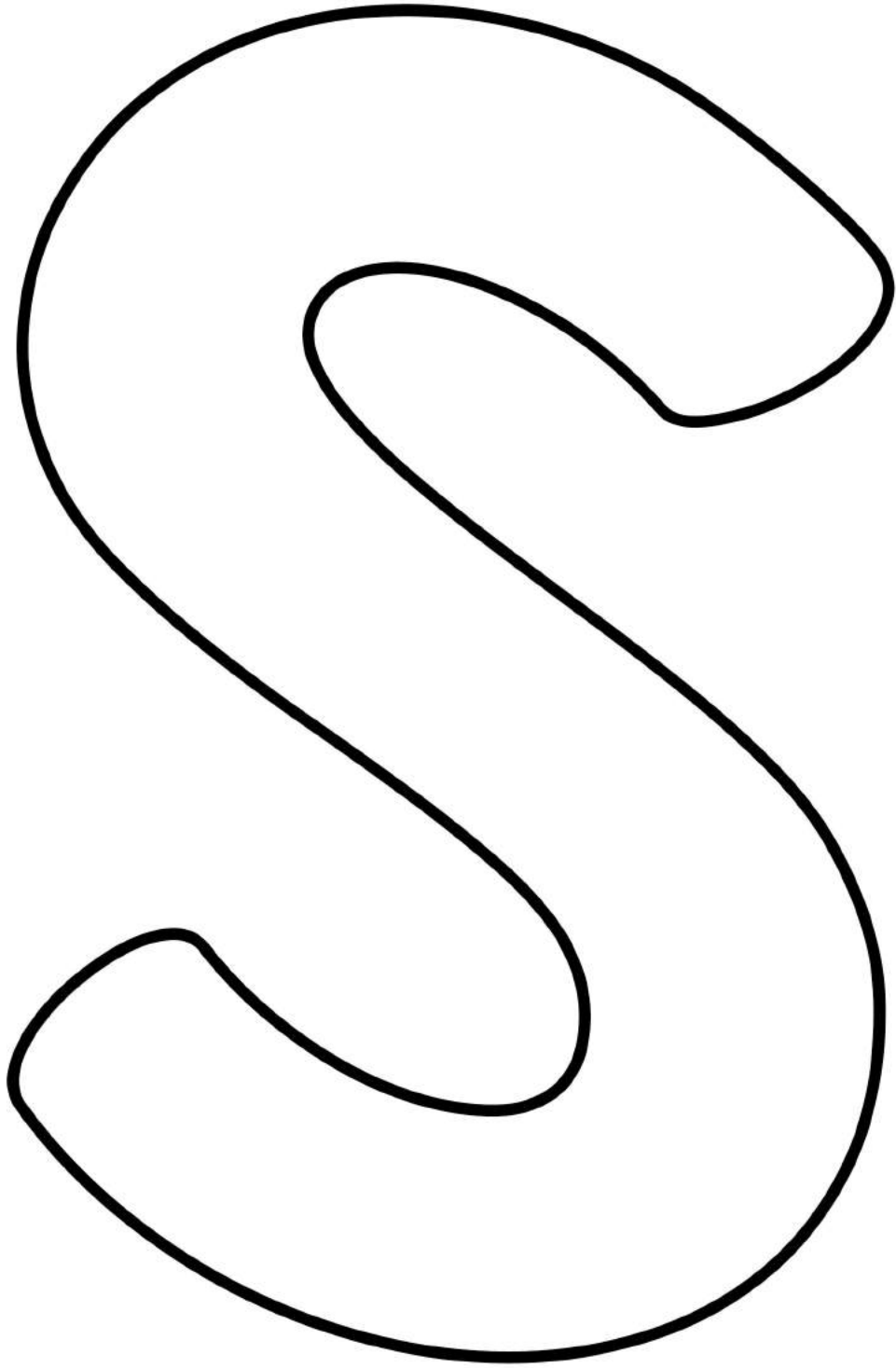

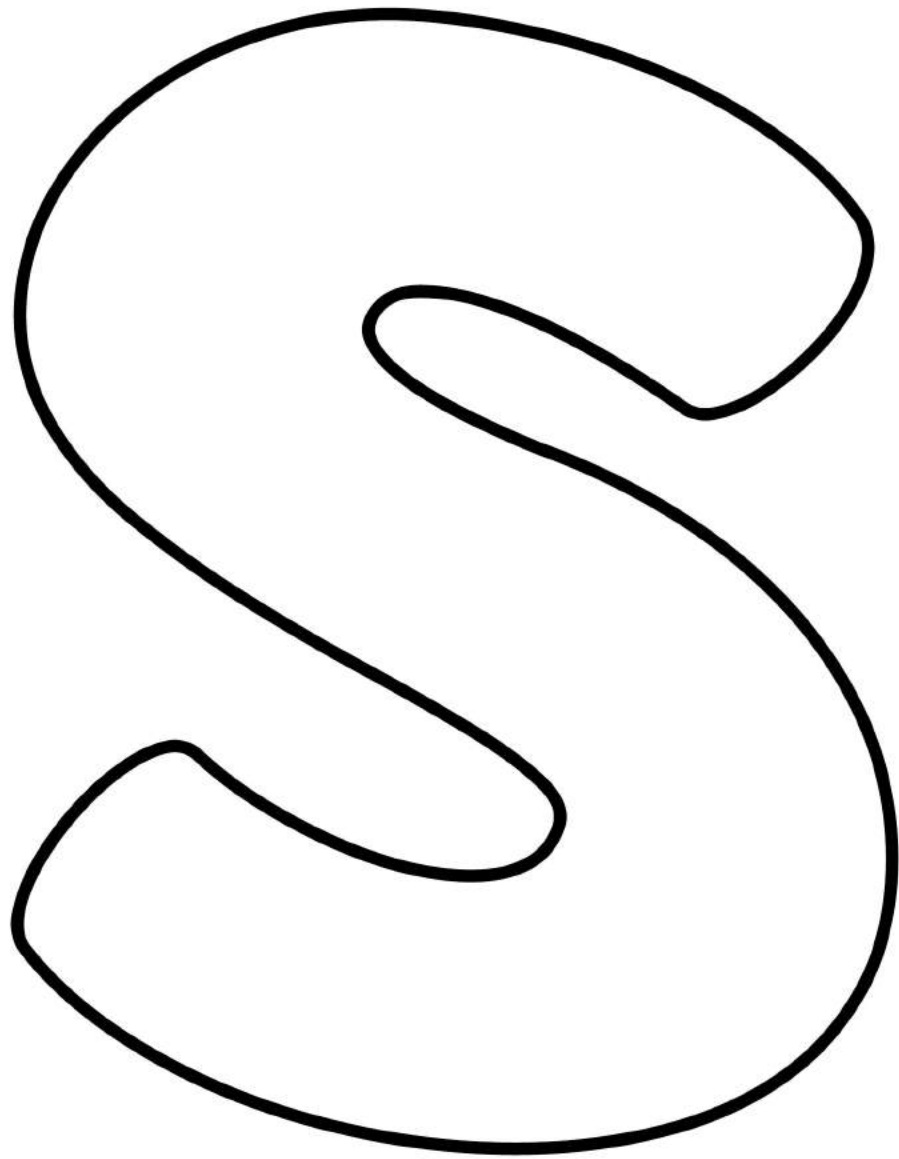

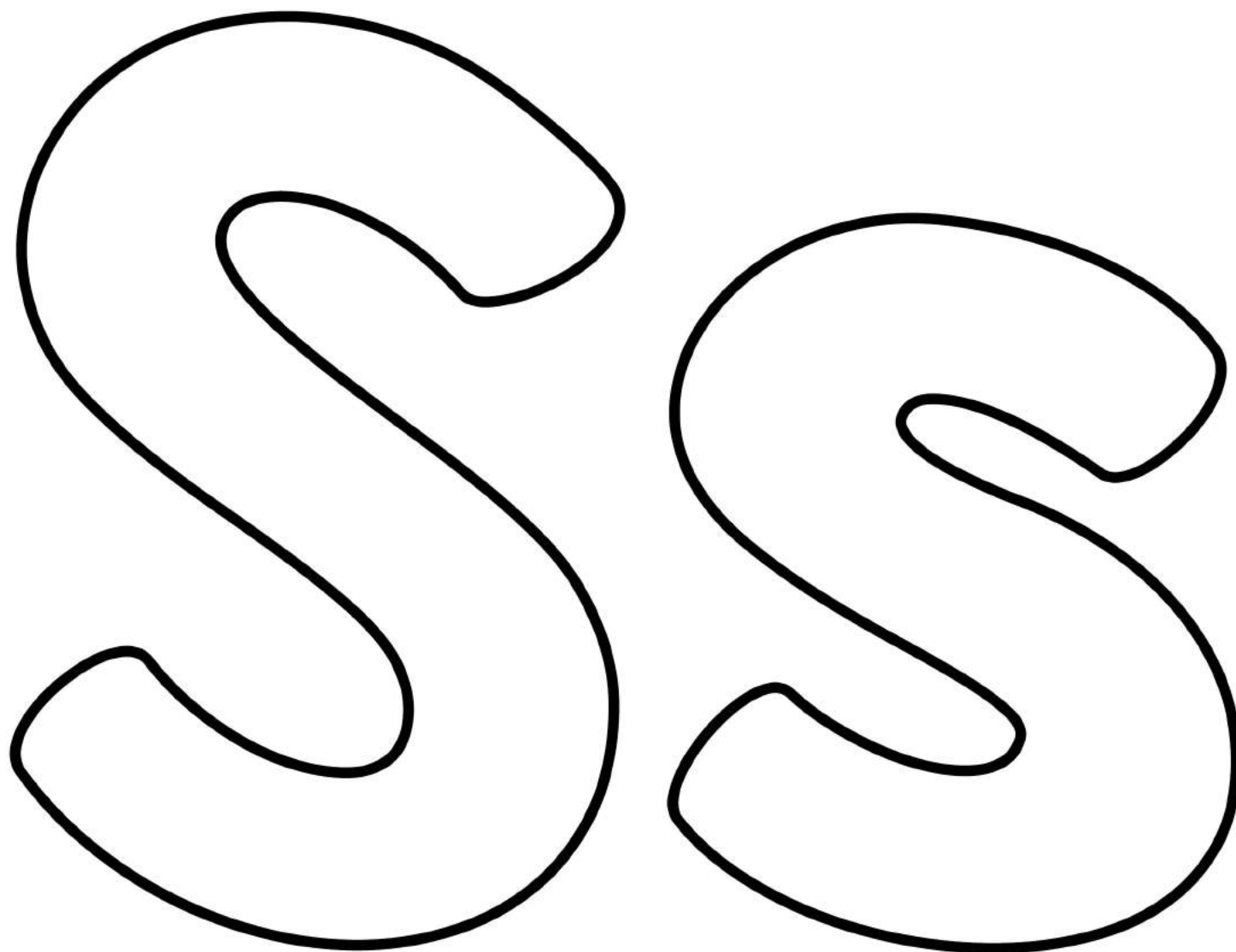

I C A N

F I N D

the letter:

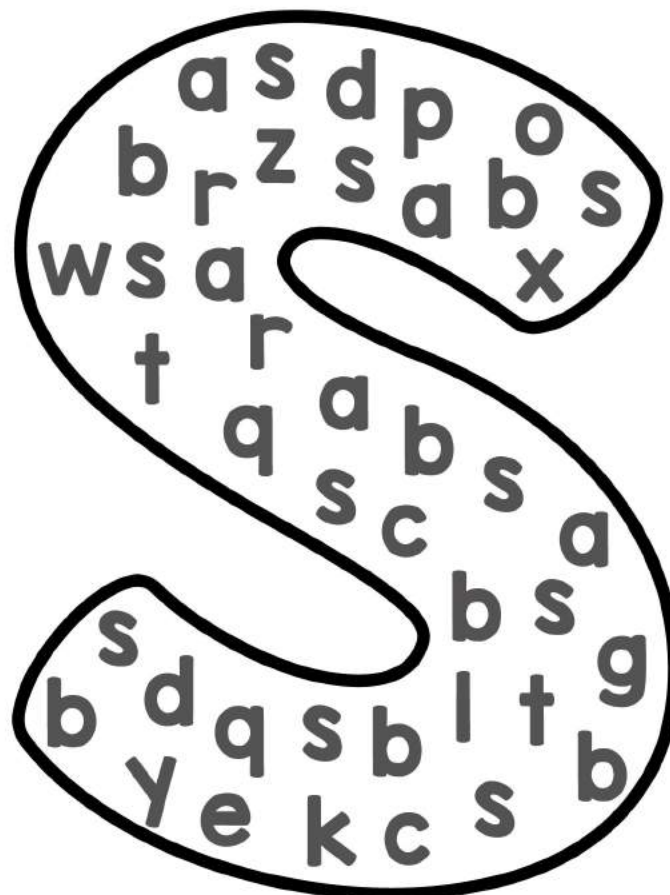
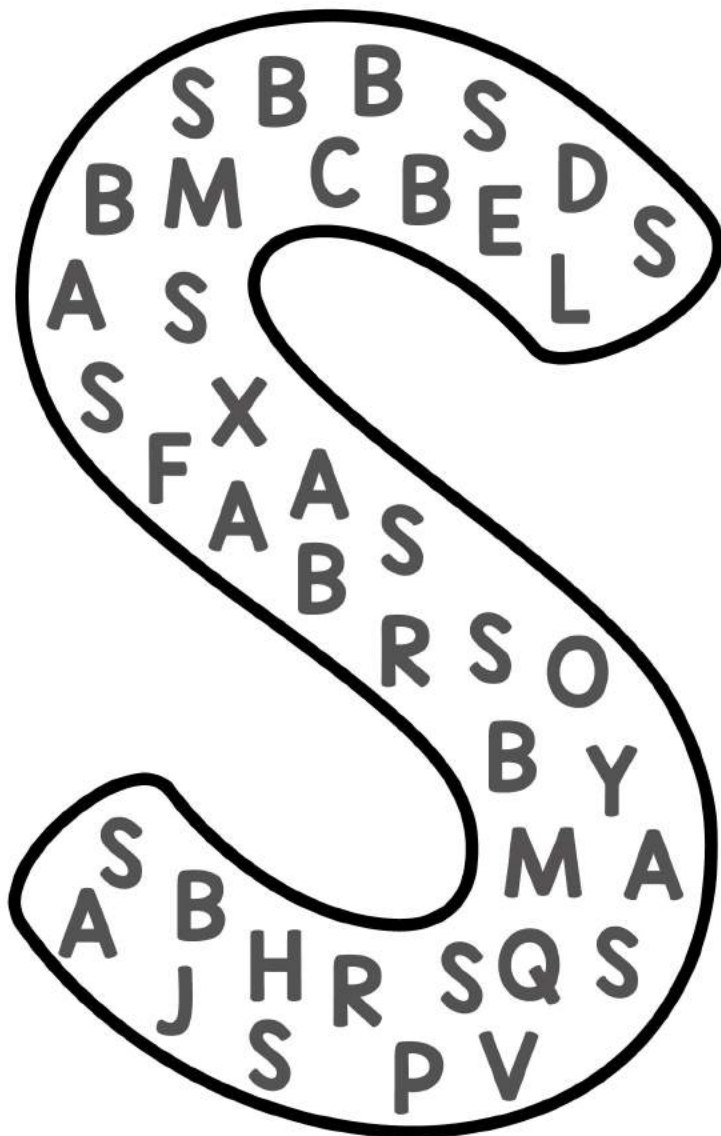

How Many?

How Many?

TRACE

NAME : _____

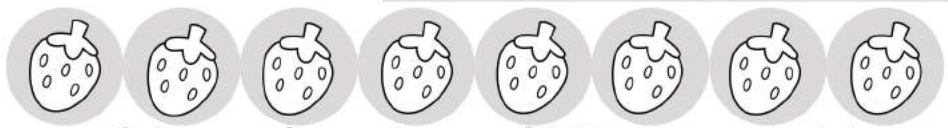

Color one for each row of letters you complete

Tracing row 1: A large uppercase 'S' with a stroke order arrow and the number '1' at the top, followed by seven identical uppercase 'S' characters on a grey background.

Tracing row 2: Eight identical uppercase 'S' characters on a grey background.

Tracing row 3: Eight identical uppercase 'S' characters on a grey background.

Tracing row 4: Eight black dots on a grey background, serving as starting points for writing the letter 'S'.

Tracing row 5: A large uppercase 'S' with a stroke order arrow and the number '1' at the top, followed by seven identical uppercase 'S' characters on a grey background.

Tracing row 6: Eight identical uppercase 'S' characters on a grey background.

Tracing row 7: Eight identical uppercase 'S' characters on a grey background.

Tracing row 8: Eight black dots on a grey background, serving as starting points for writing the letter 'S'.

C · O · U · N · T

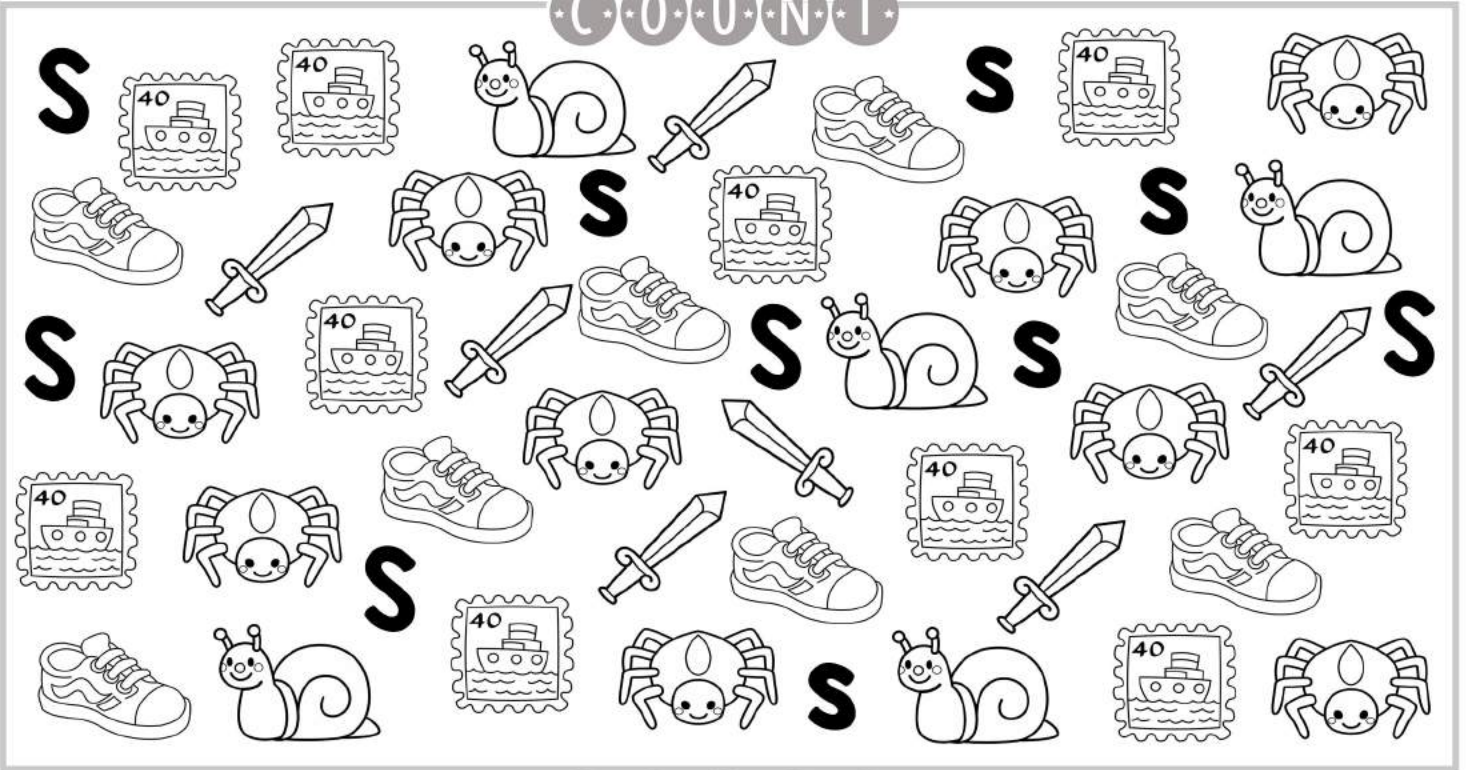

G · R · A · P · H

S	S					

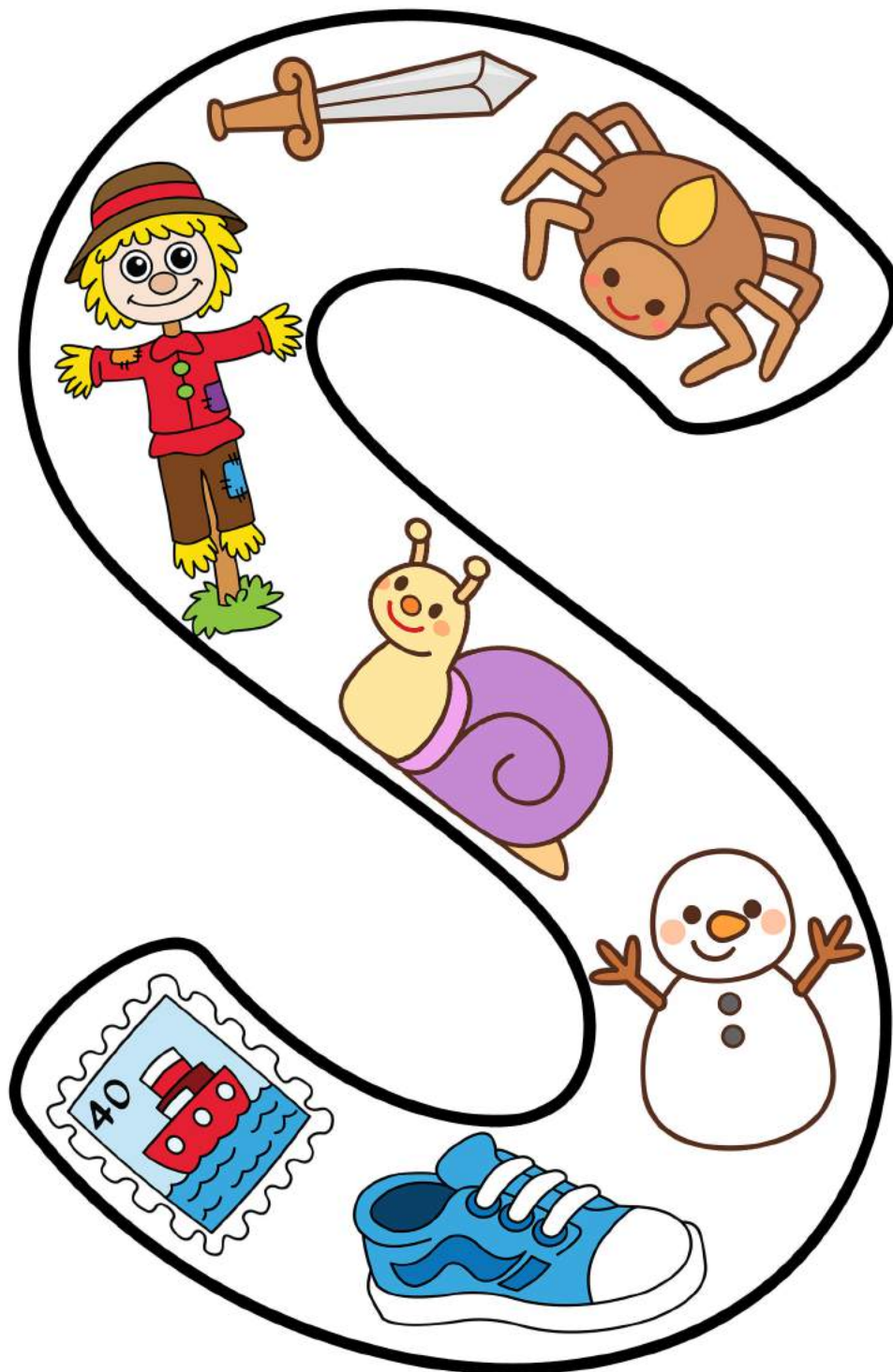

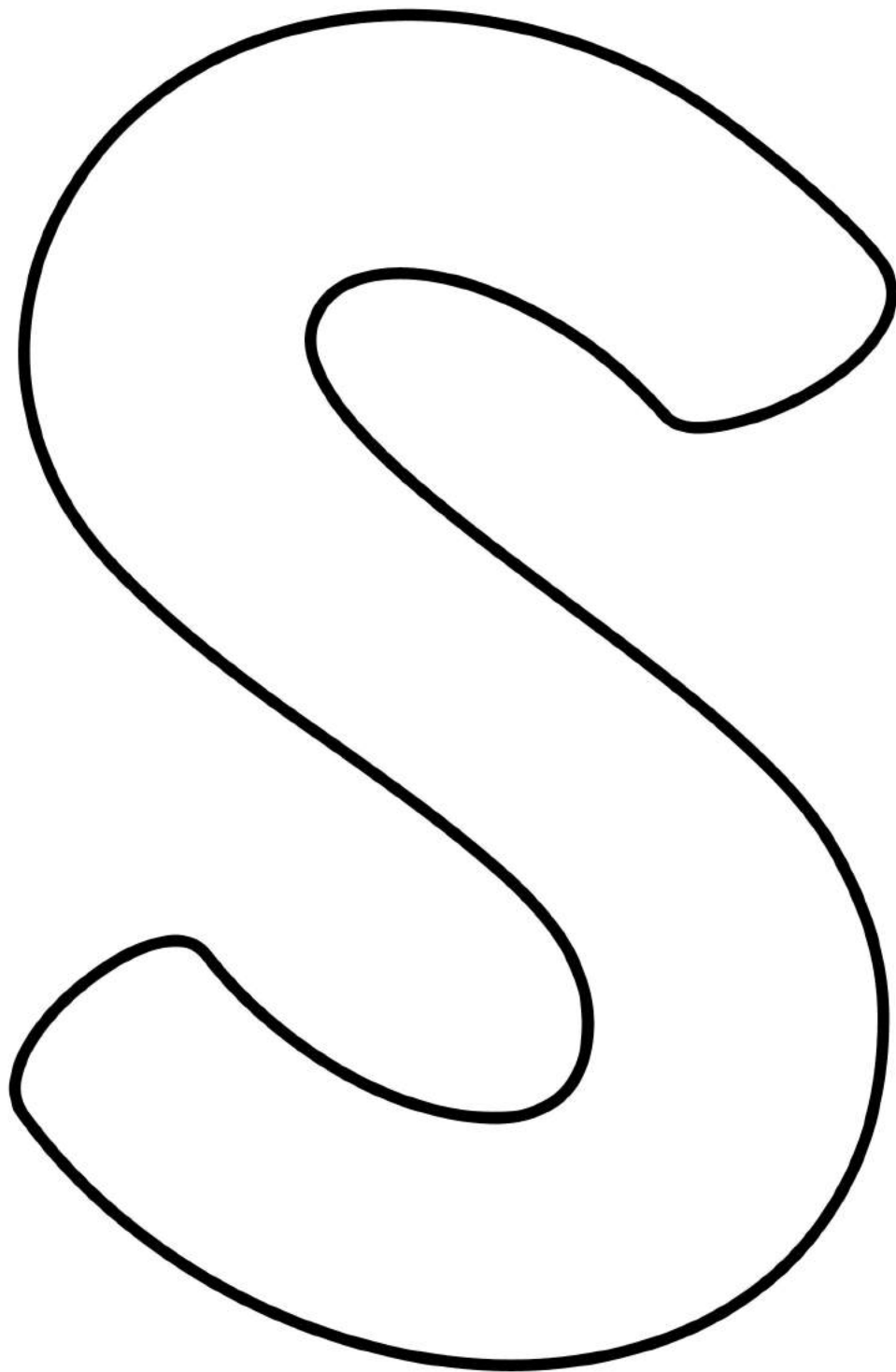

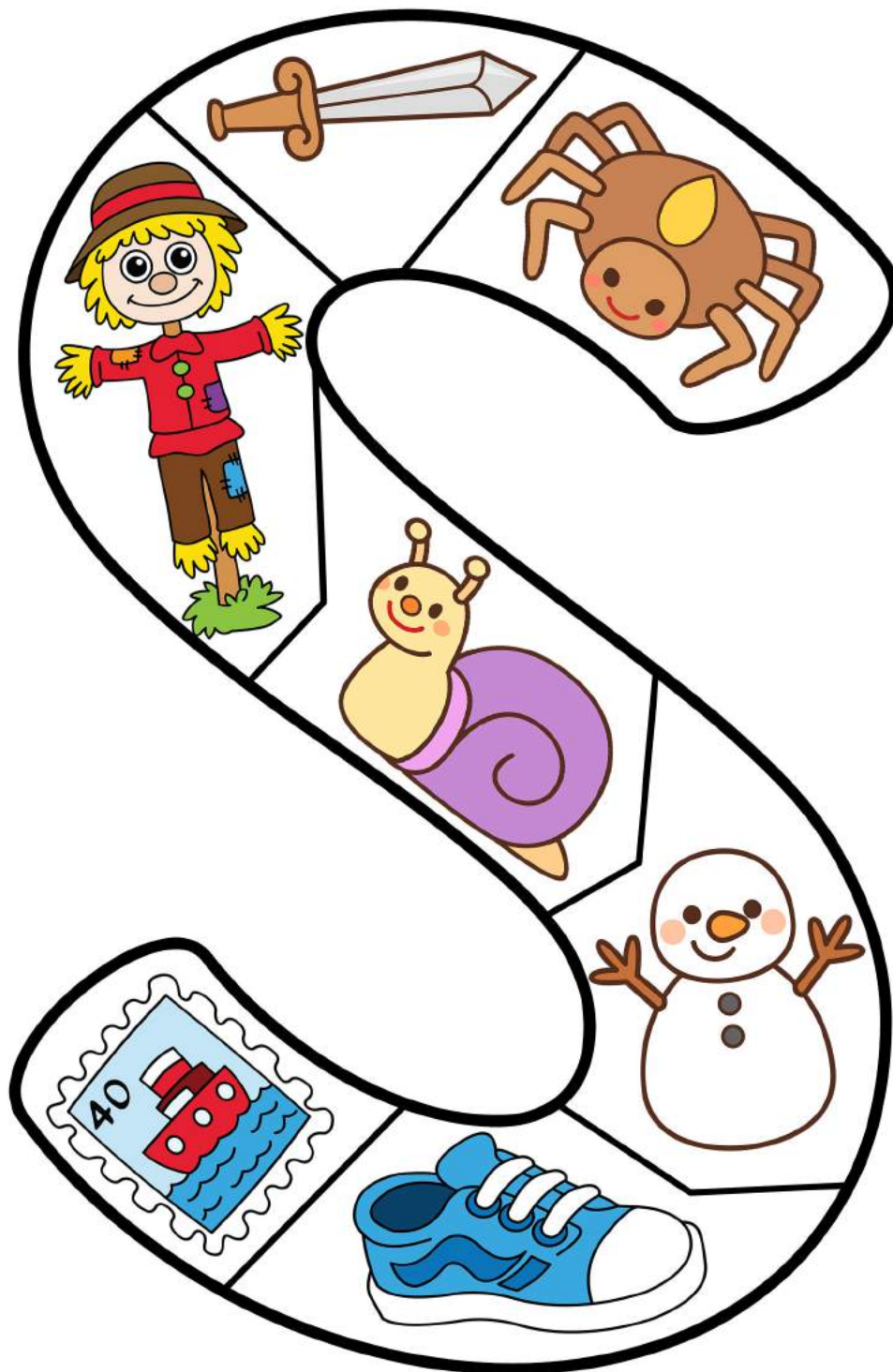

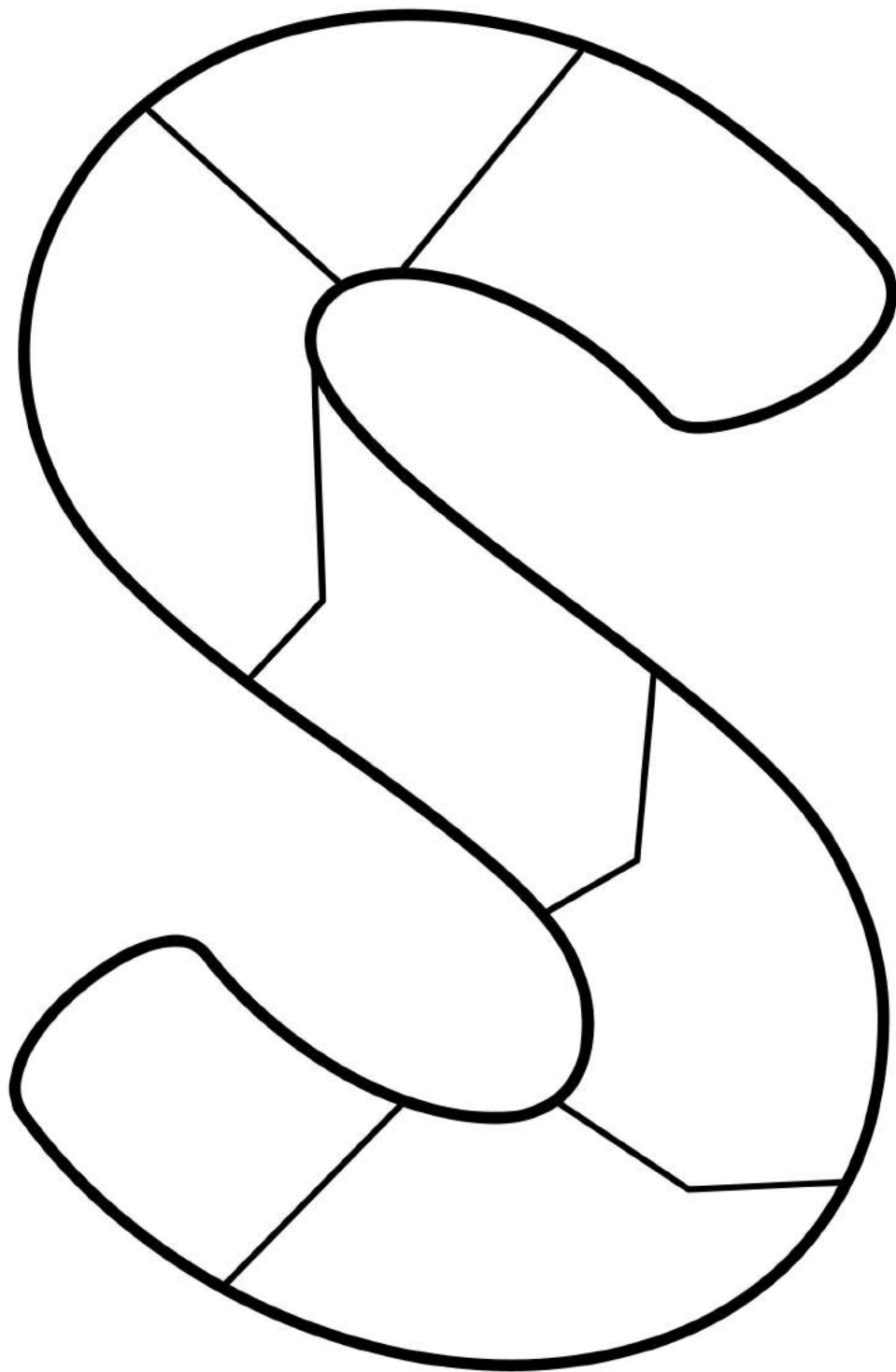

1. Write

2. Cut Out 

NAME : _____

S S

S S

S S

S S

S S

A B C Q U I L T

3. Color

4. Cut out 



NAME : _____

NAME : _____

Ss

Write and read words that begin with letter s.

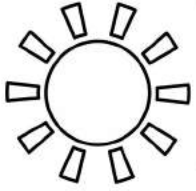

sun sun sun



sock sock



soap soap



shoe shoe



snail snail

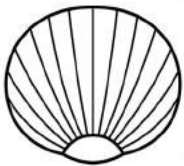

shell shell



sword sword

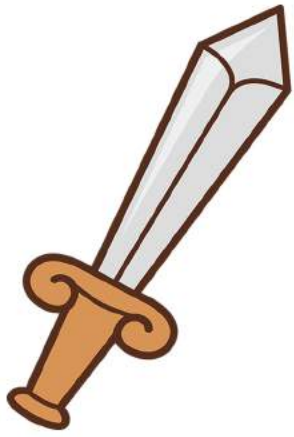

sword

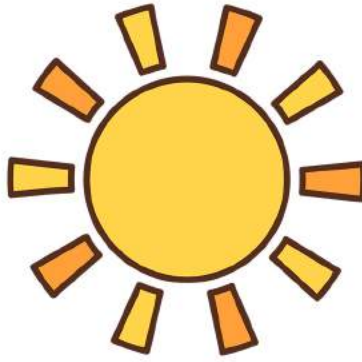

sun



snail



spider



shoe



snowman

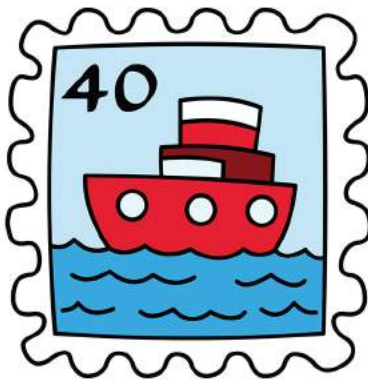

stamp



shovel

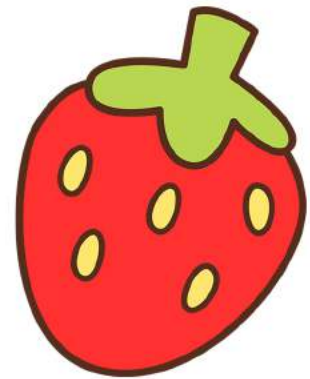

strawberry

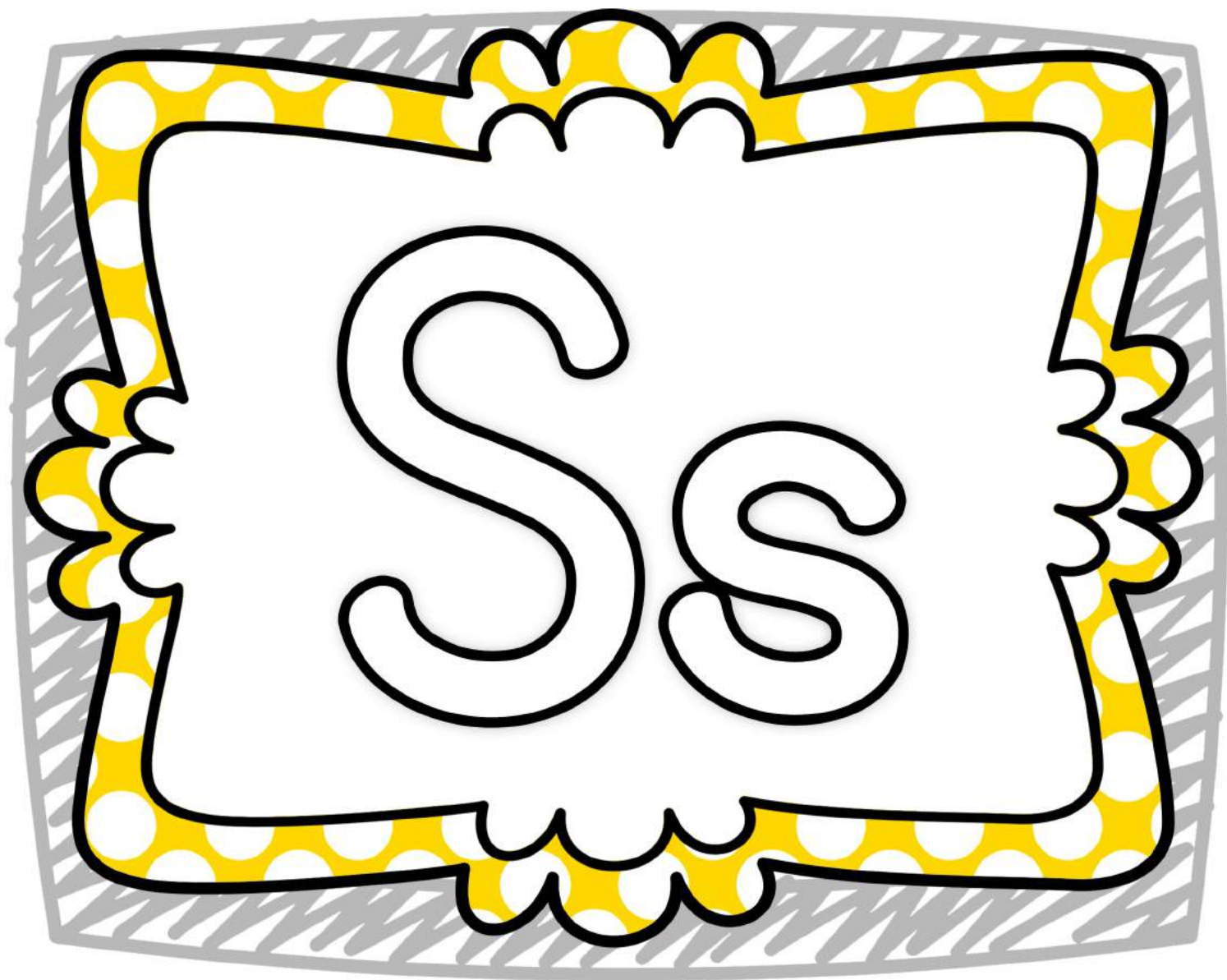

LETTER S



4 IN A ROW

LETTER S



4 IN A ROW

Images (c) Little Red's Clipart, Zip-a-De-Doo-Dah Designs & Miss Giraffe

LETTER S



4 IN A ROW

LETTER S



4 IN A ROW

I CAN WRITE

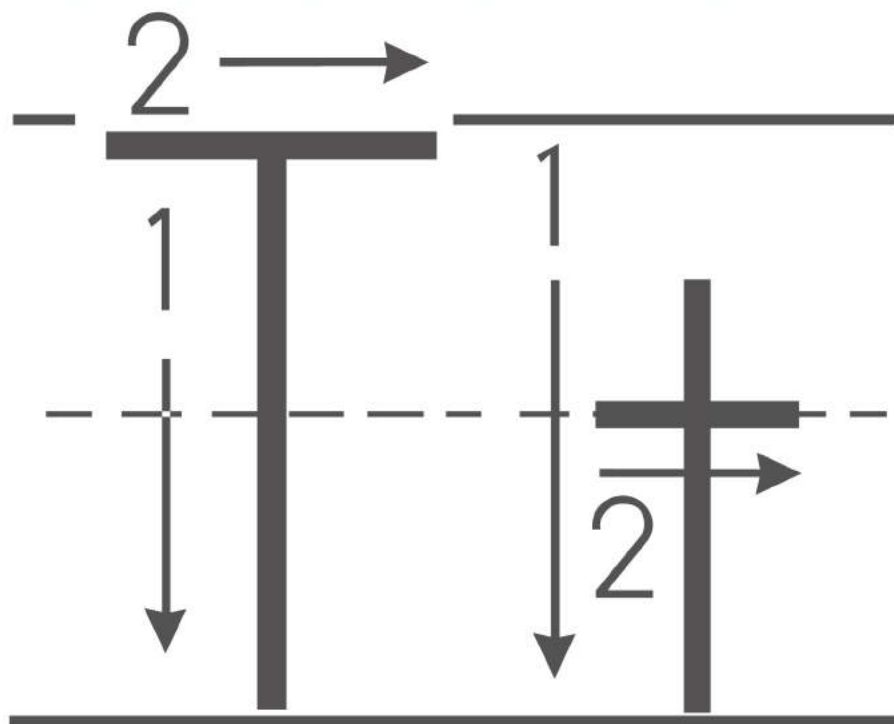

Line Down

Pick up

Cross the Top

Line Down

Pick up

Cross the
middle

Tractor

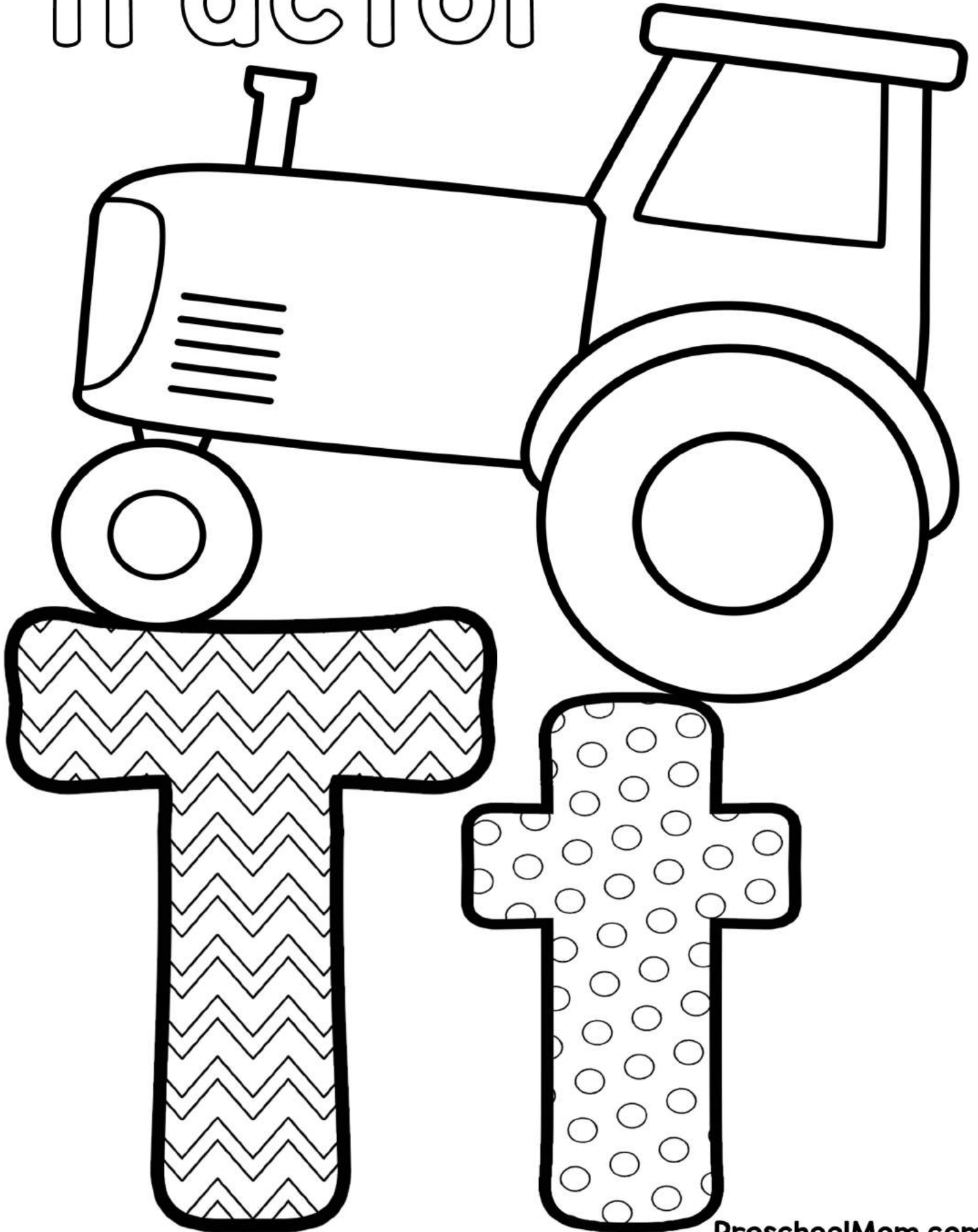

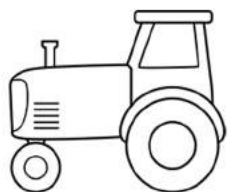
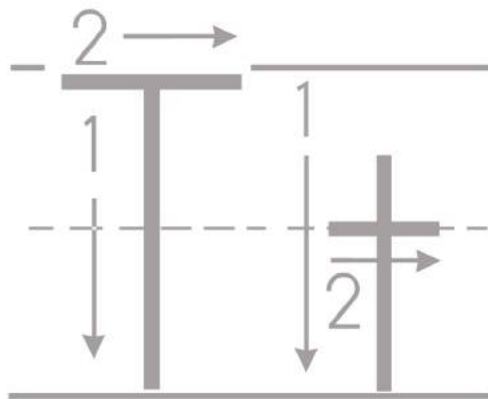

tractor

tie

taco

tree

teacup

tent

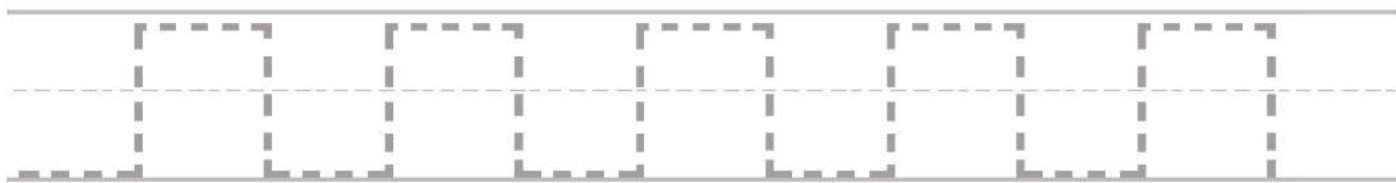

Circle the correct teacup:

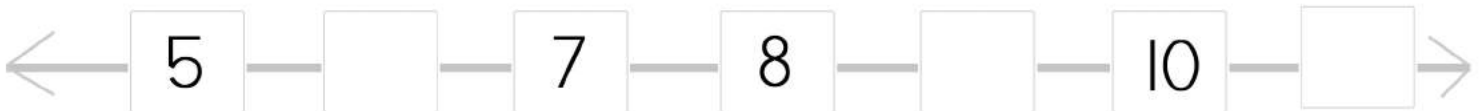
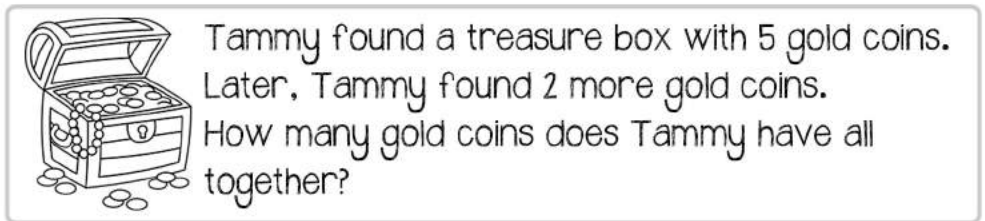
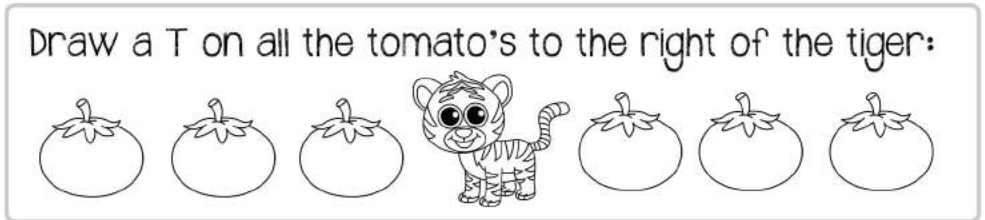
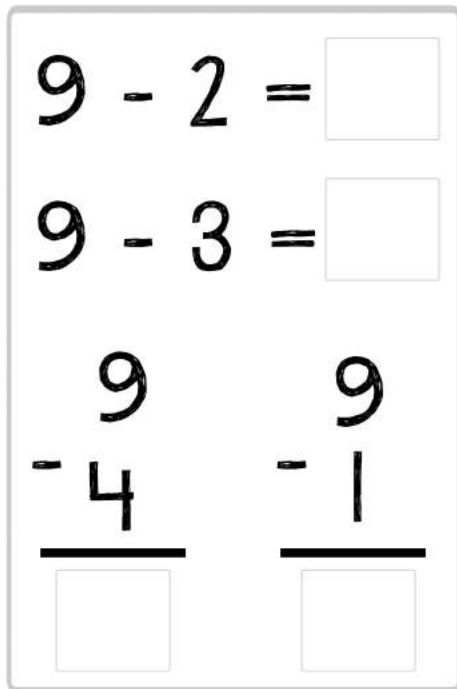
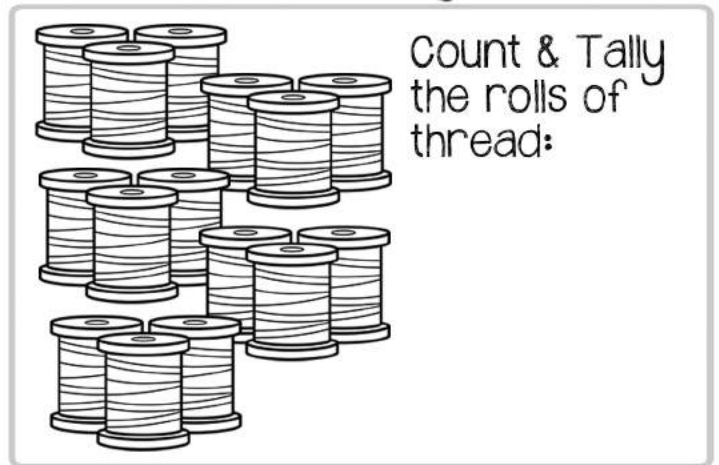
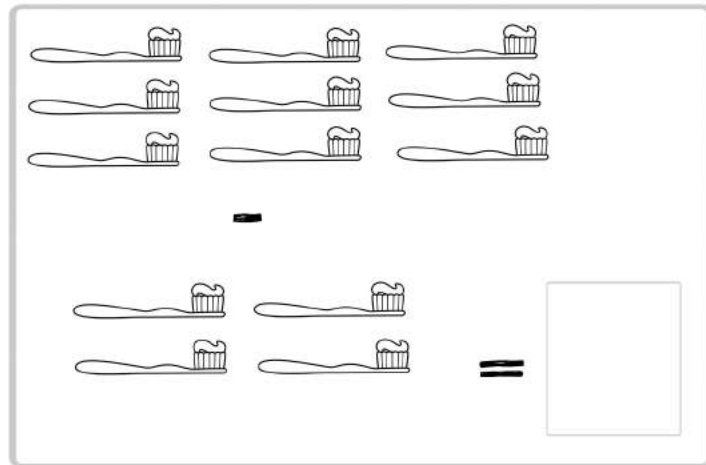
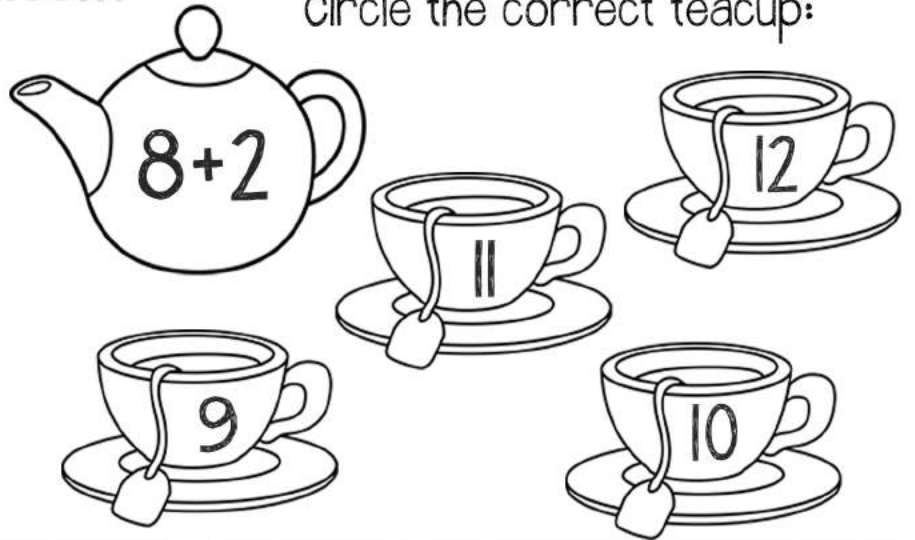
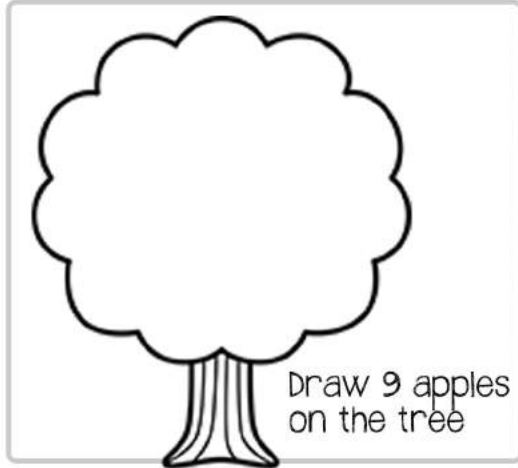

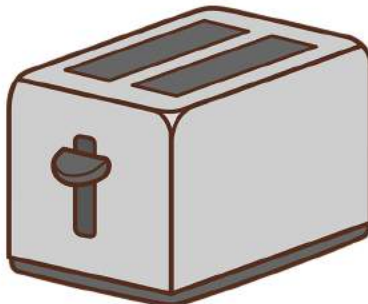
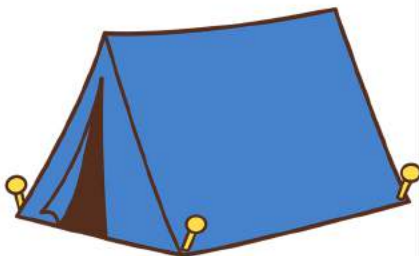
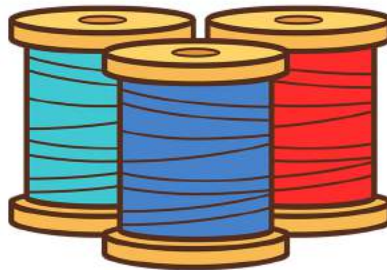
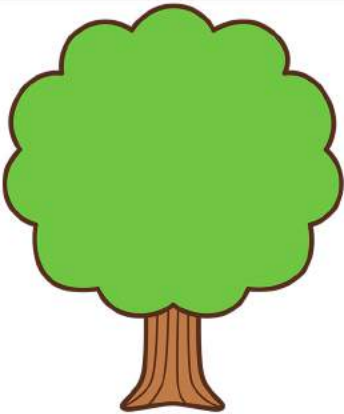
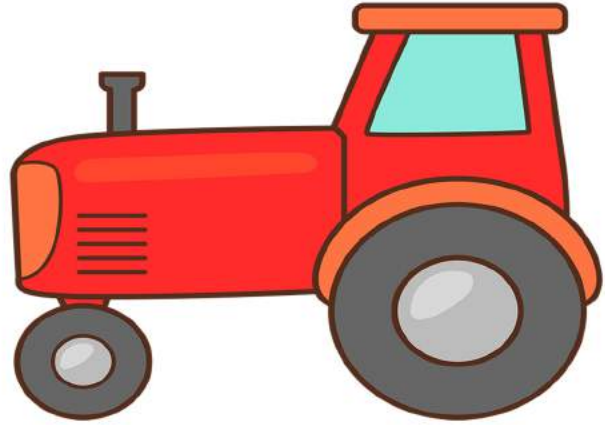

T t





I CAN COLOR

 = tractor

 = taco

 = tie

 = tree

 = tent

 = teacup

words with:

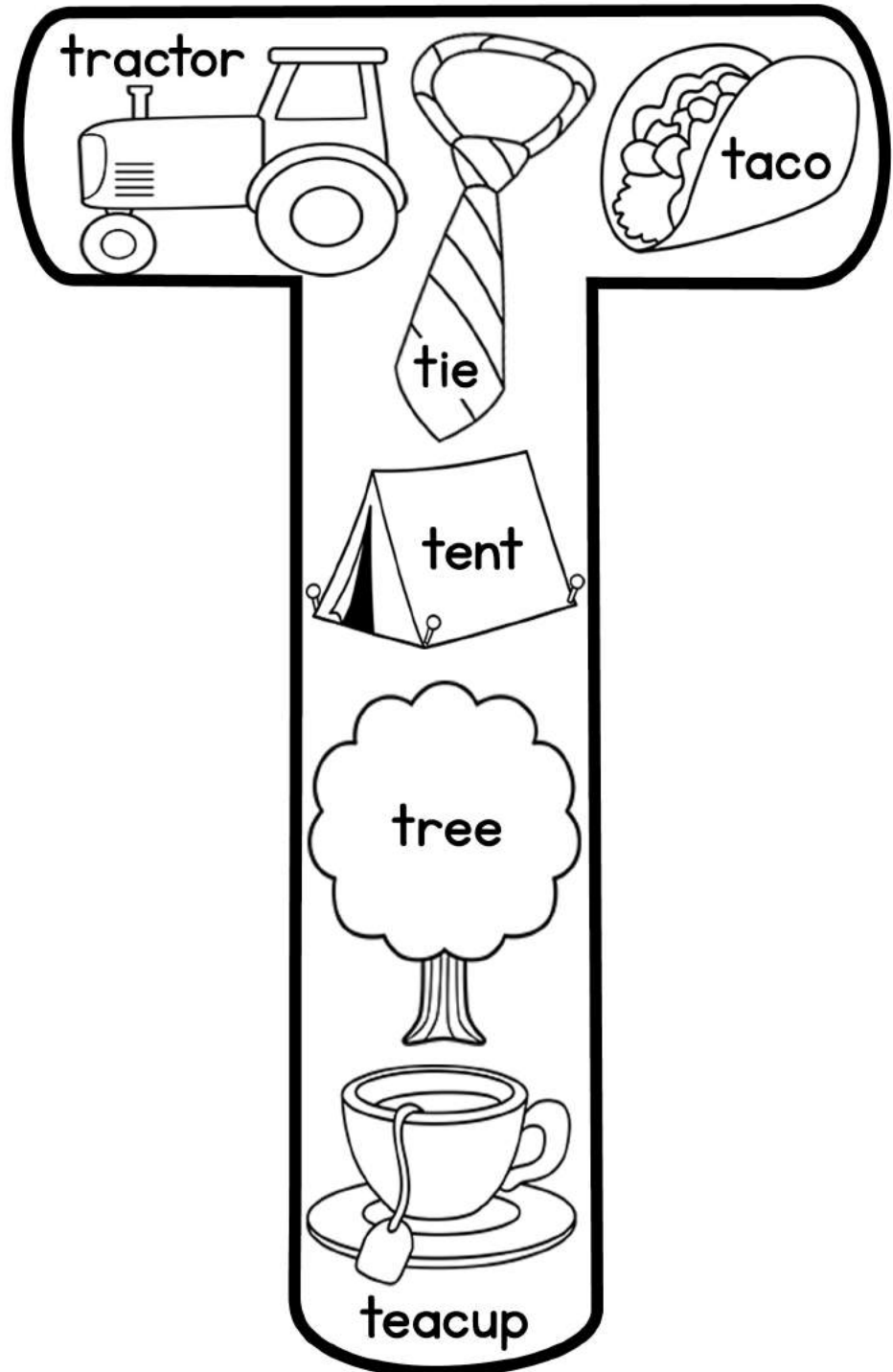

NAME : _____

Tt

Write and read words that begin with letter t.



tea tea tea



tie tie tie tie



tree tree



tent tent



tiger tiger

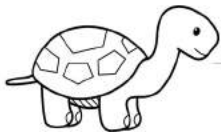

turtle turtle



treasure

NAME : _____

Tt

Write and read words that begin with letter t.



T tea T tea T tea



T tie T tie T tie

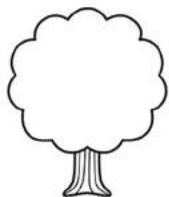

T tree T tree



T tent T tent



T tiger T tiger

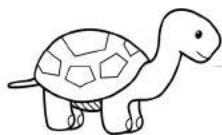

T turtle T turtle



T treasure

NAME : _____

RACE TO THE TOP

Use a paperclip and a pencil to complete the spinner.

T	t
T	t
T	t
T	t
T	t
T	t
T	t
T	t
T	t
T	t

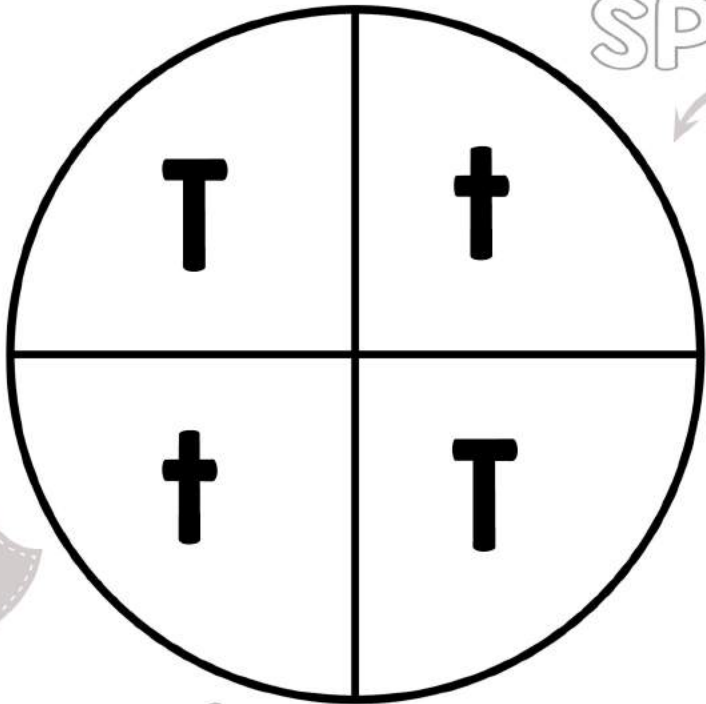

SPIN

Record

Report:

How many spins landed on T?

How many spins landed on t?

Which had more?

Write an inequality: >

How many spins total?

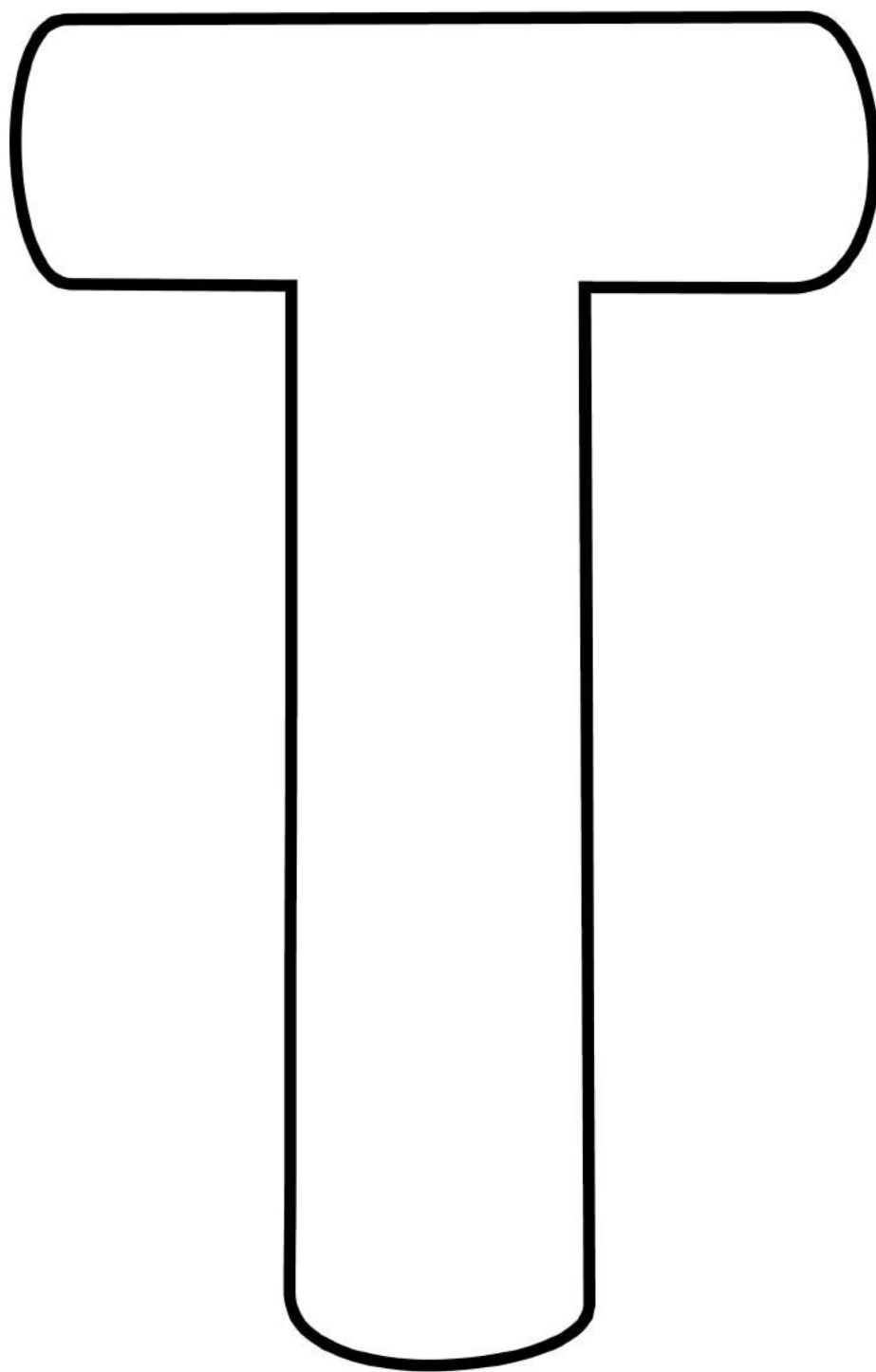

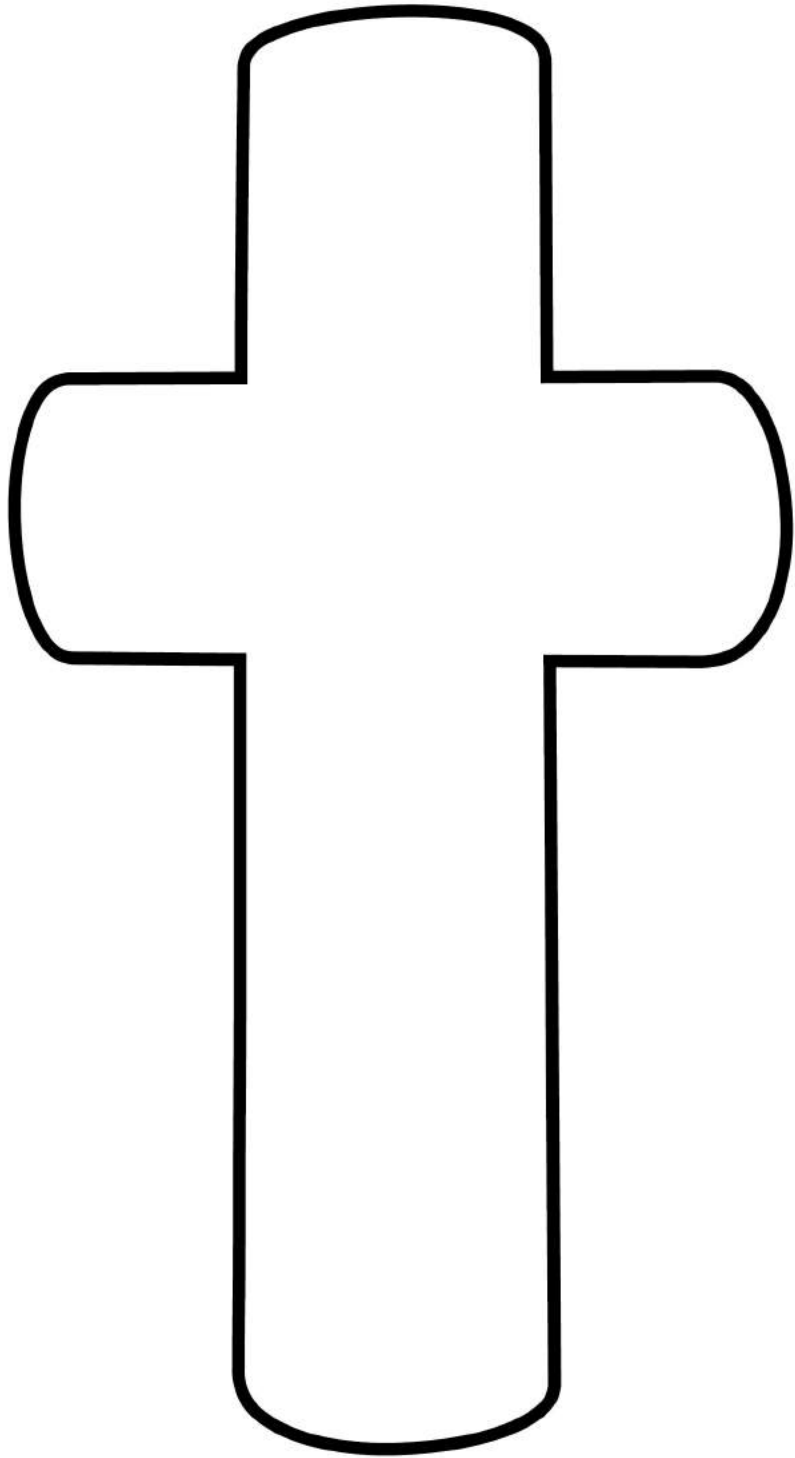

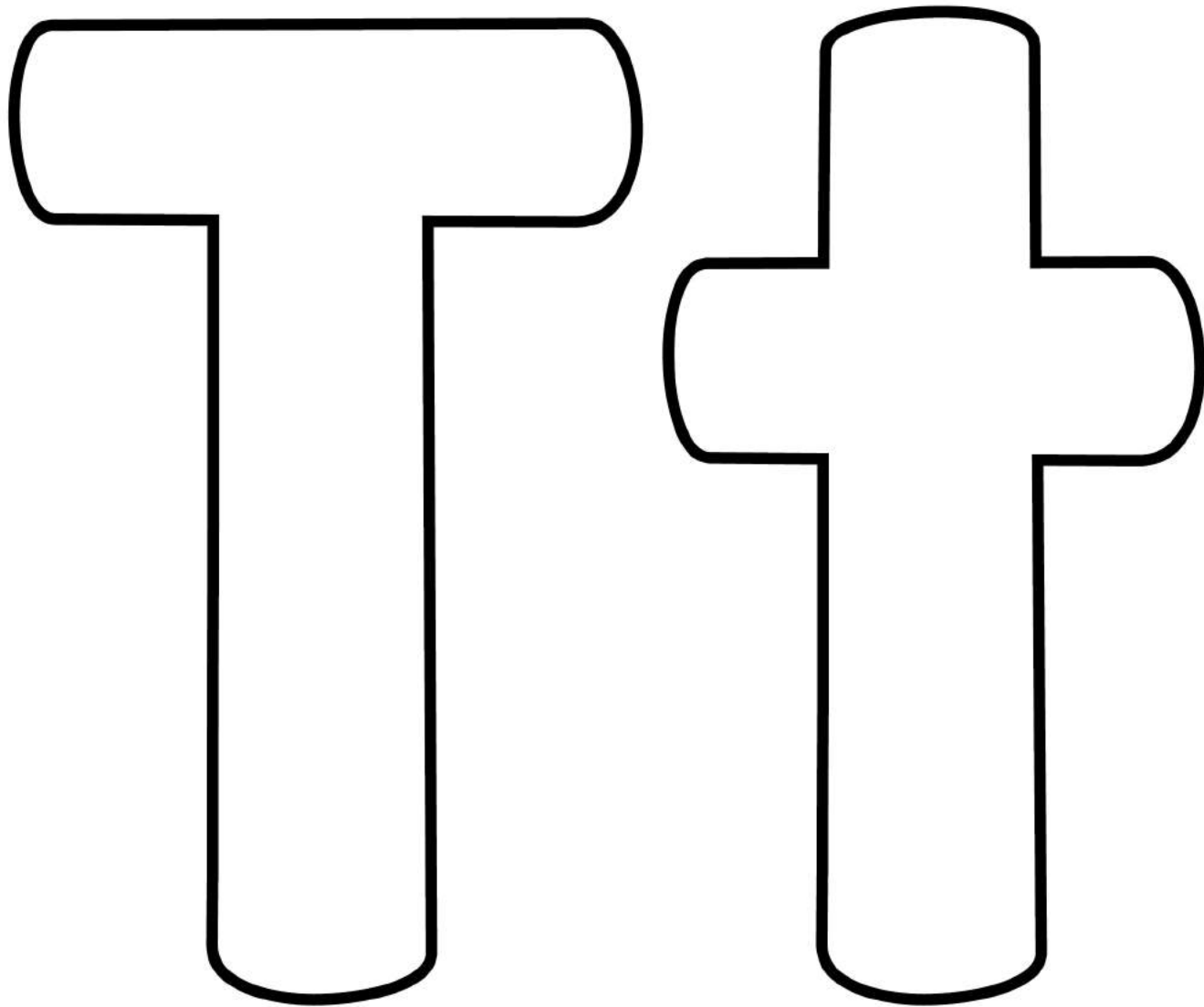

★ I ★

★ C ★ ★ A ★ ★ N ★

★ F ★ ★ I ★ ★ N ★ ★ D ★

the letter:

T Q S B R R O S
W T R M S N T R

M R
T S T R
R E Q
T R T
Q N T
T S P
C M T
W R T
M
T R N

m t
s r i t
e o n
s m r
t a s r m
b m t q s p t s
o q o s o s t
p t k
k t r
q k r c
b k r s
s s t s
t p e g
s t s

How Many?

How Many?

TRACE

NAME : _____

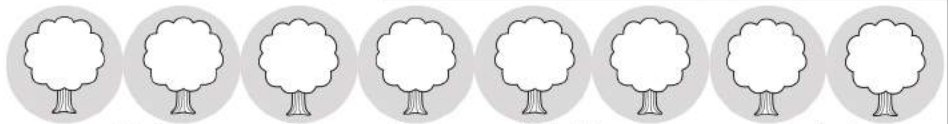



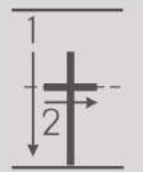
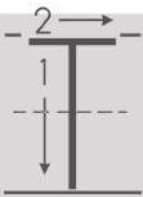

Color one for each row of letters you complete

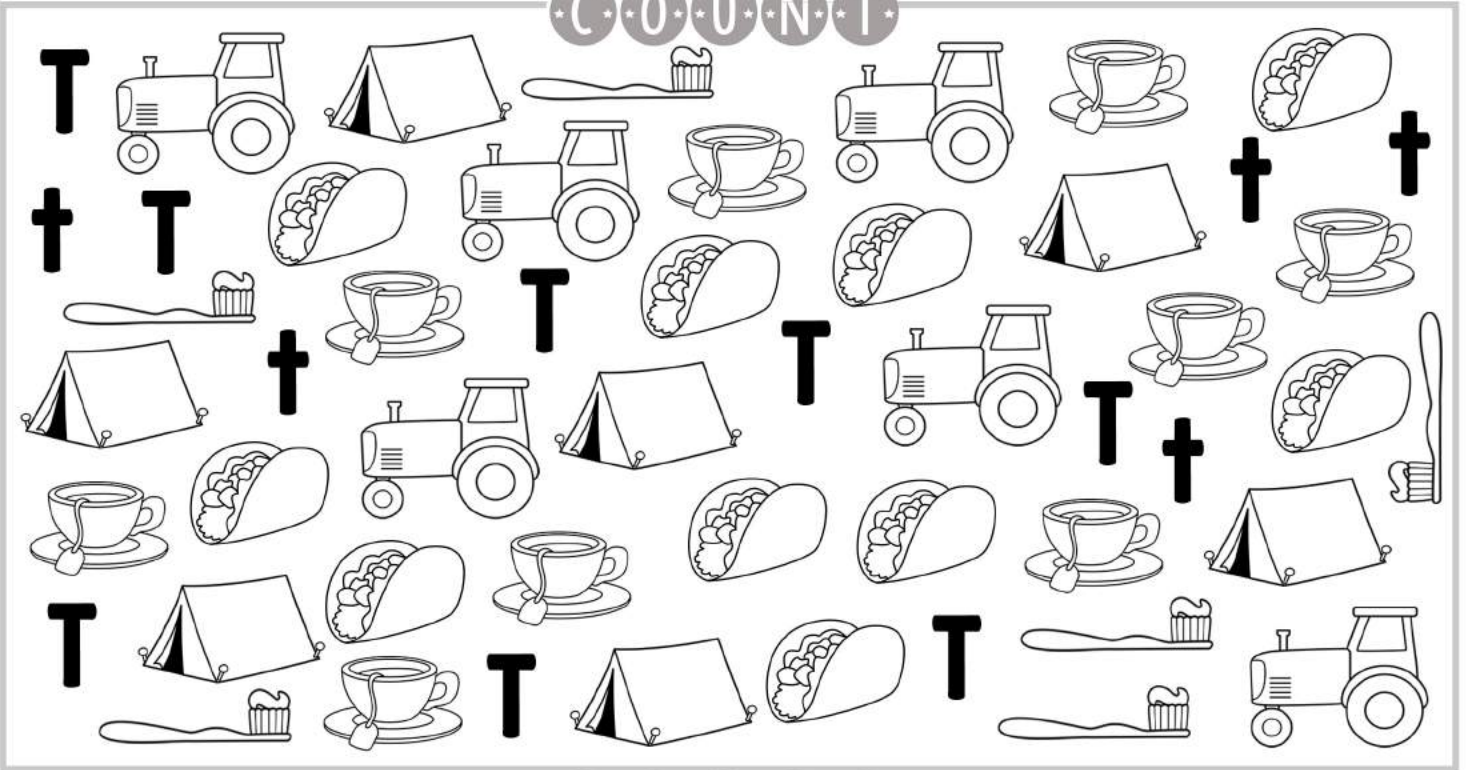

C O U N T



G R A P H

T	t					

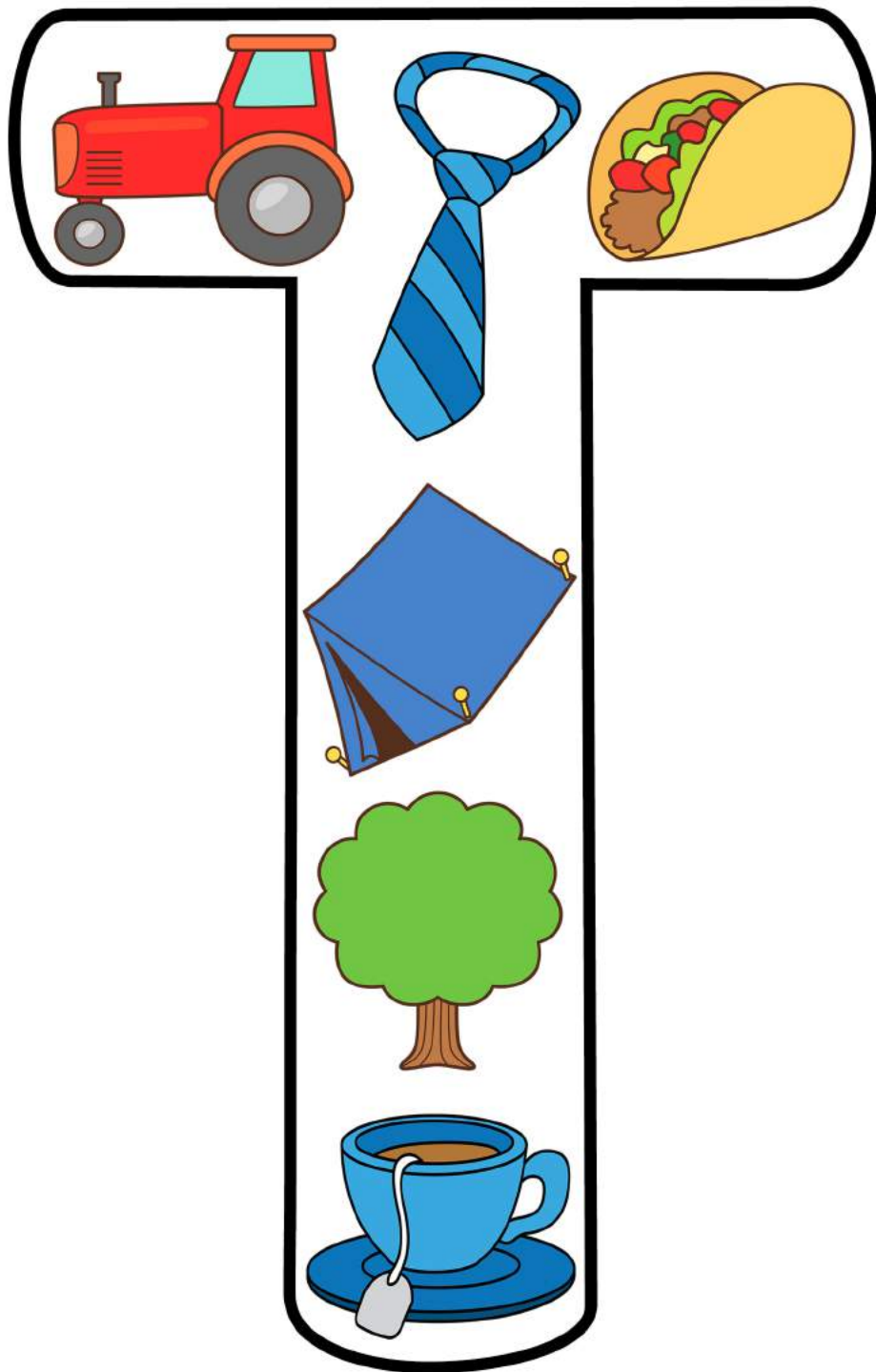

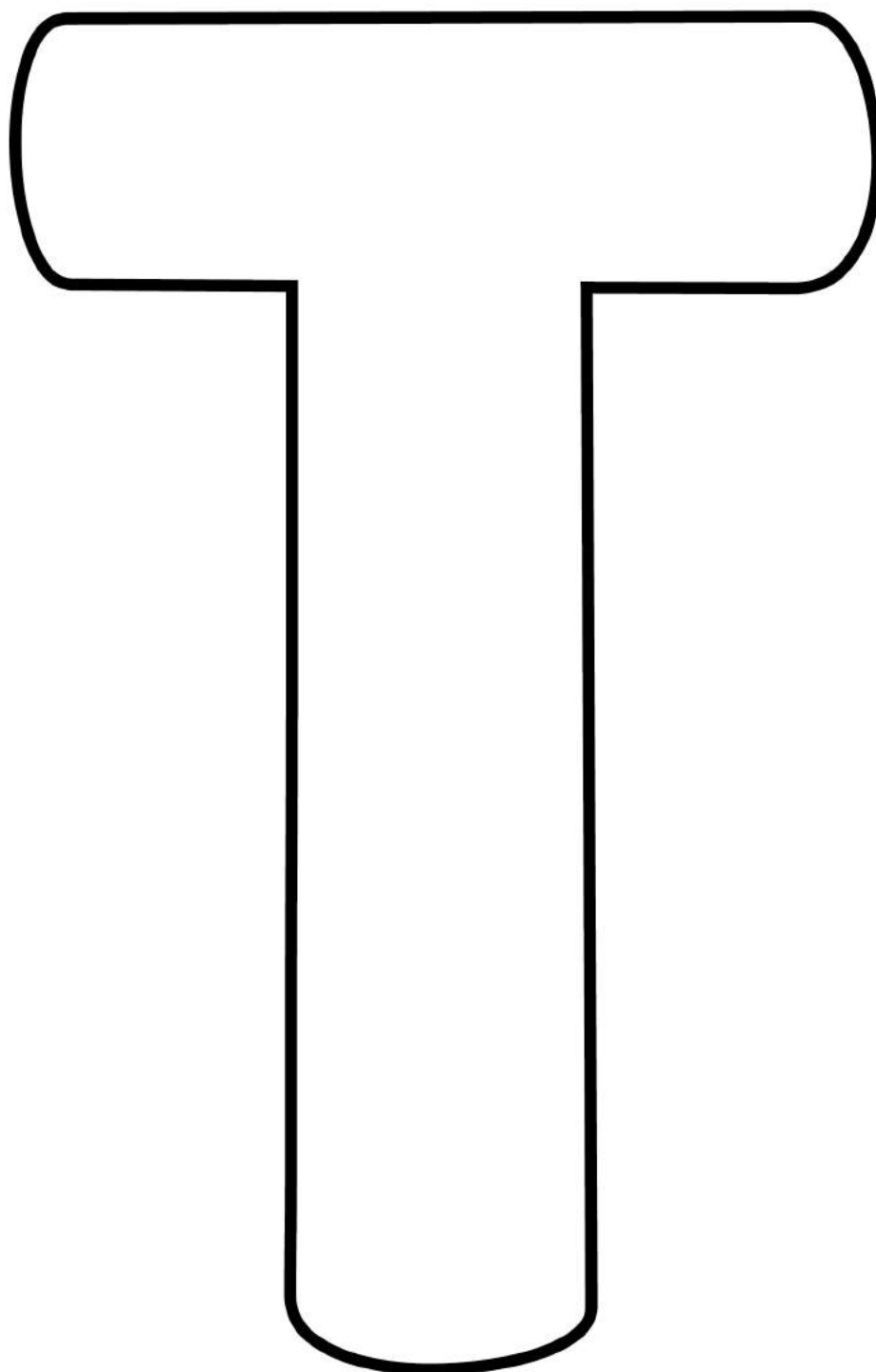

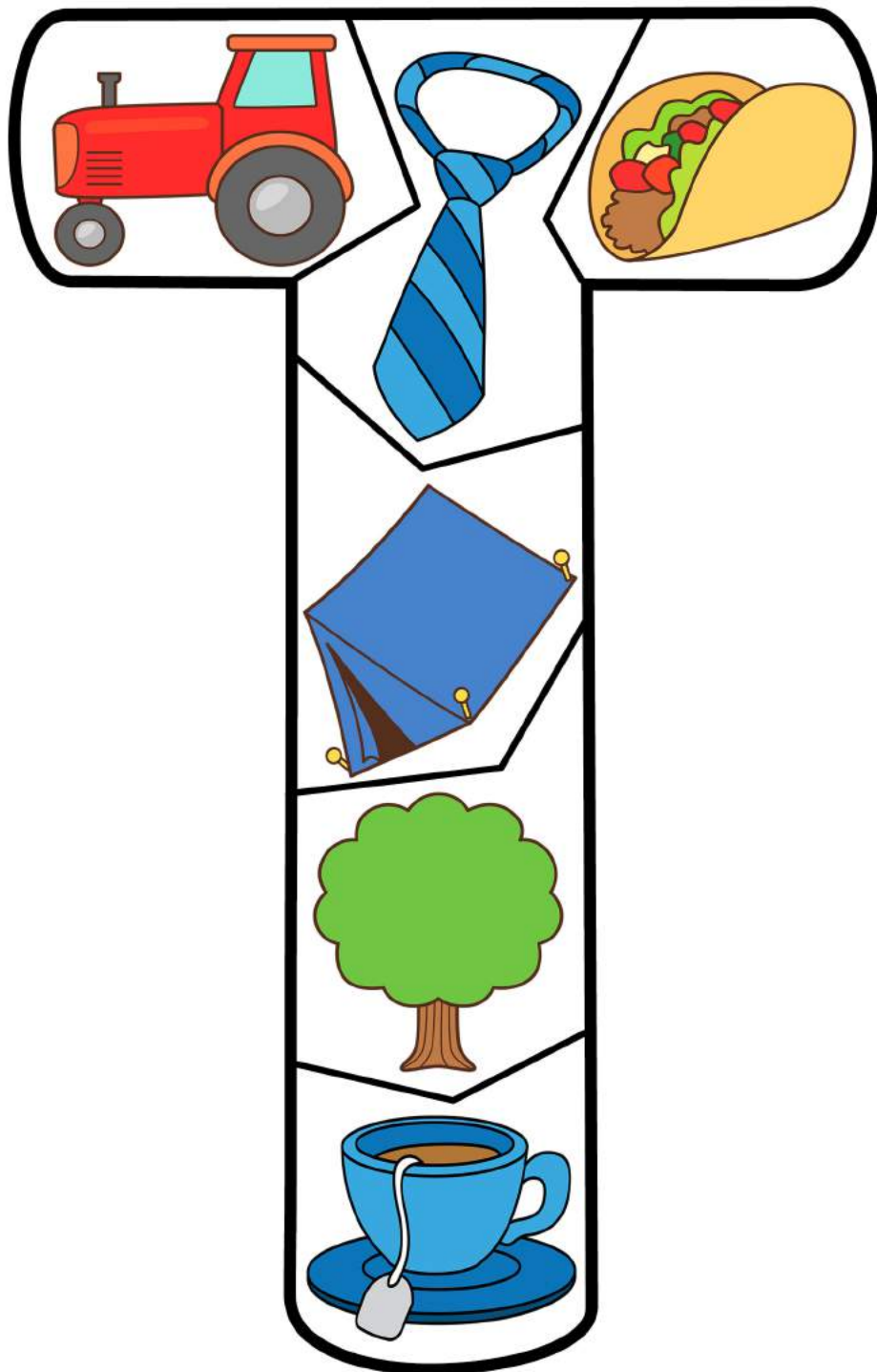

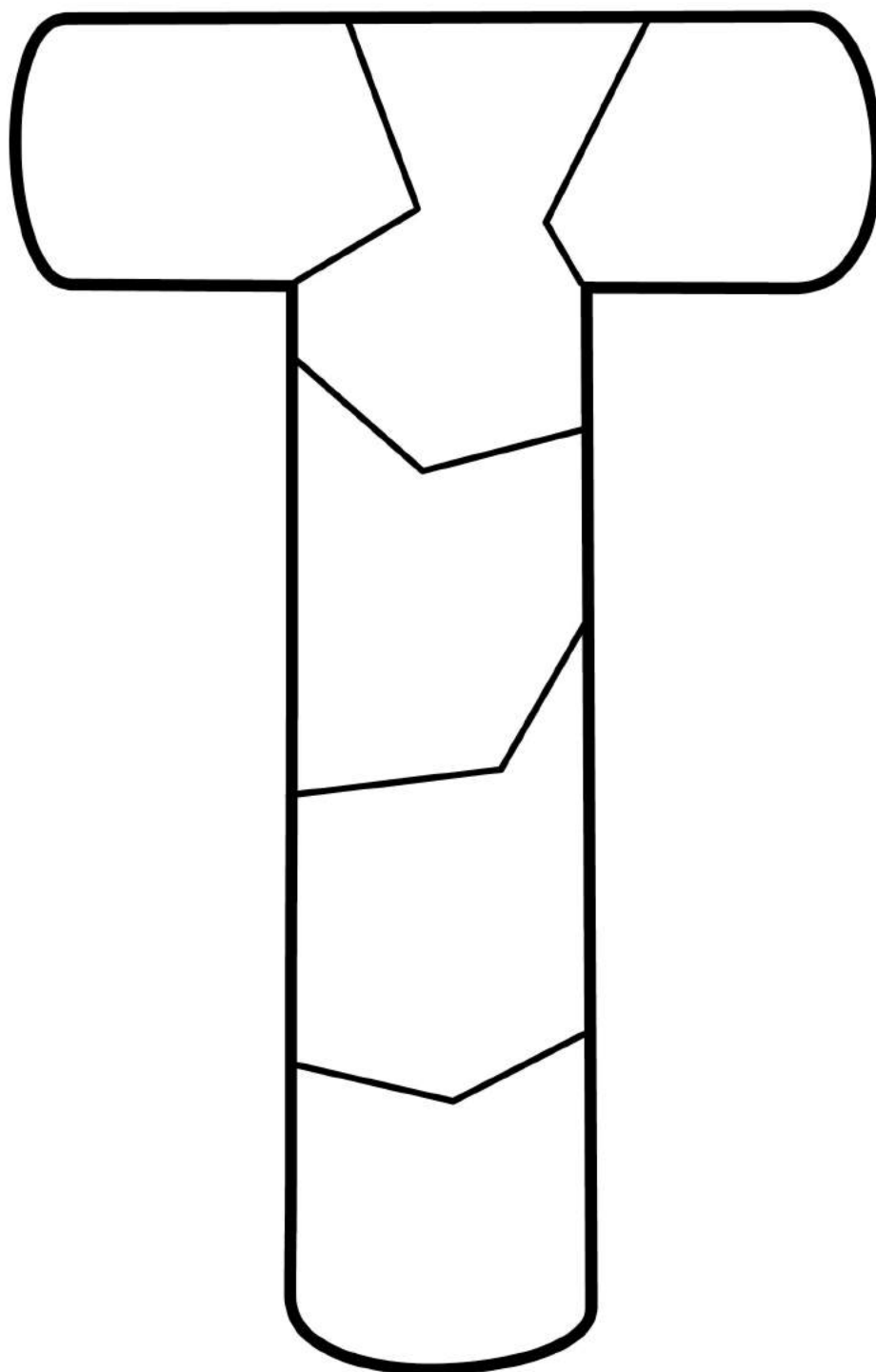

1. Write

2. Cut Out 

A B C Q U I L T

3. Color

4. Cut out 

NAME : _____

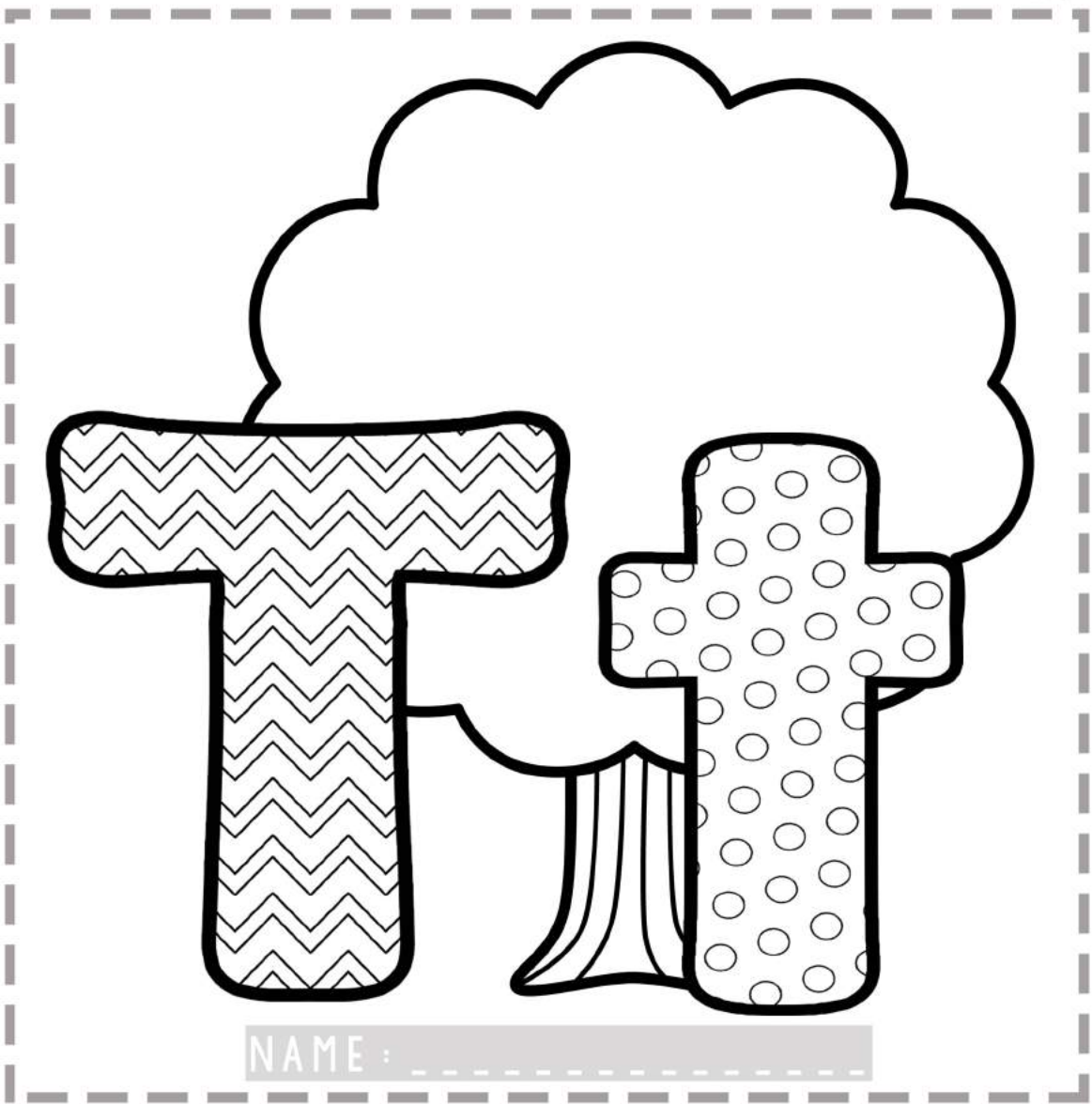

NAME : _____

Tt

Write and read words that begin with letter t.



tea tea tea



tie tie tie



tree tree



tent tent



tiger tiger

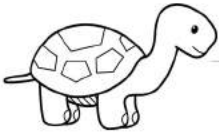

turtle turtle



treasure



taco

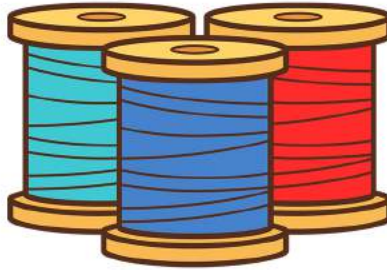

thread



teacup

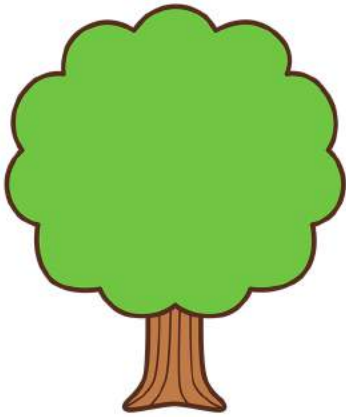

tree

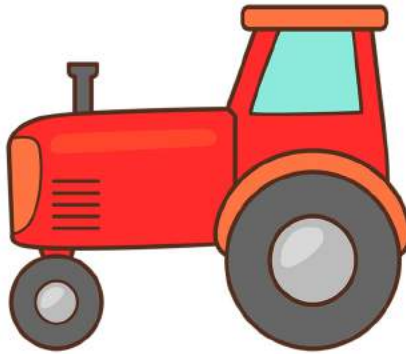

tractor

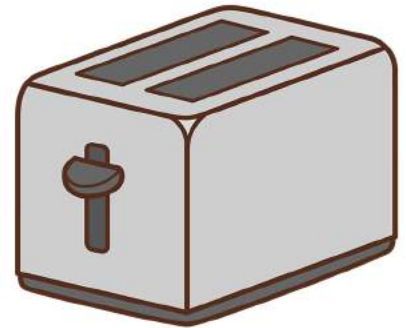

toaster

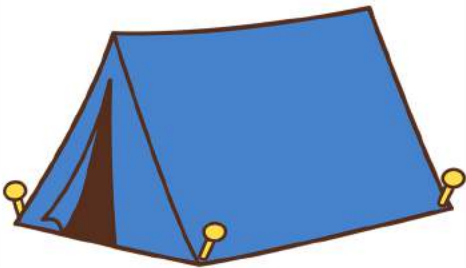

tent



tie



tennis

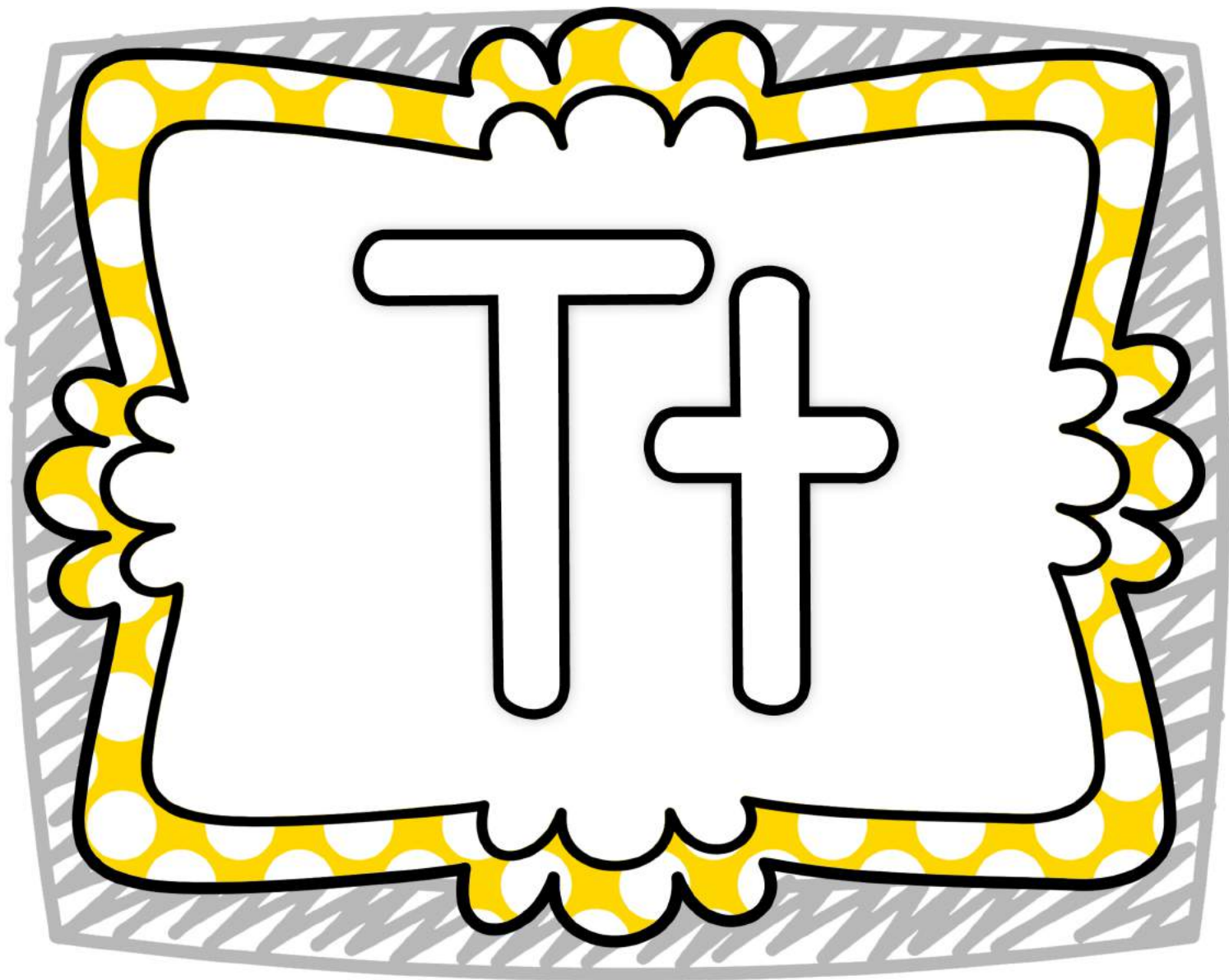

LETTER T



4 IN A ROW

LETTER T



4 IN A ROW

Images (c) Little Red's Clipart, Zip-a-De-Doo-Dah Designs & Miss Giraffe

LETTER T



4 IN A ROW

LETTER T



4 IN A ROW

I C A N W R I T E

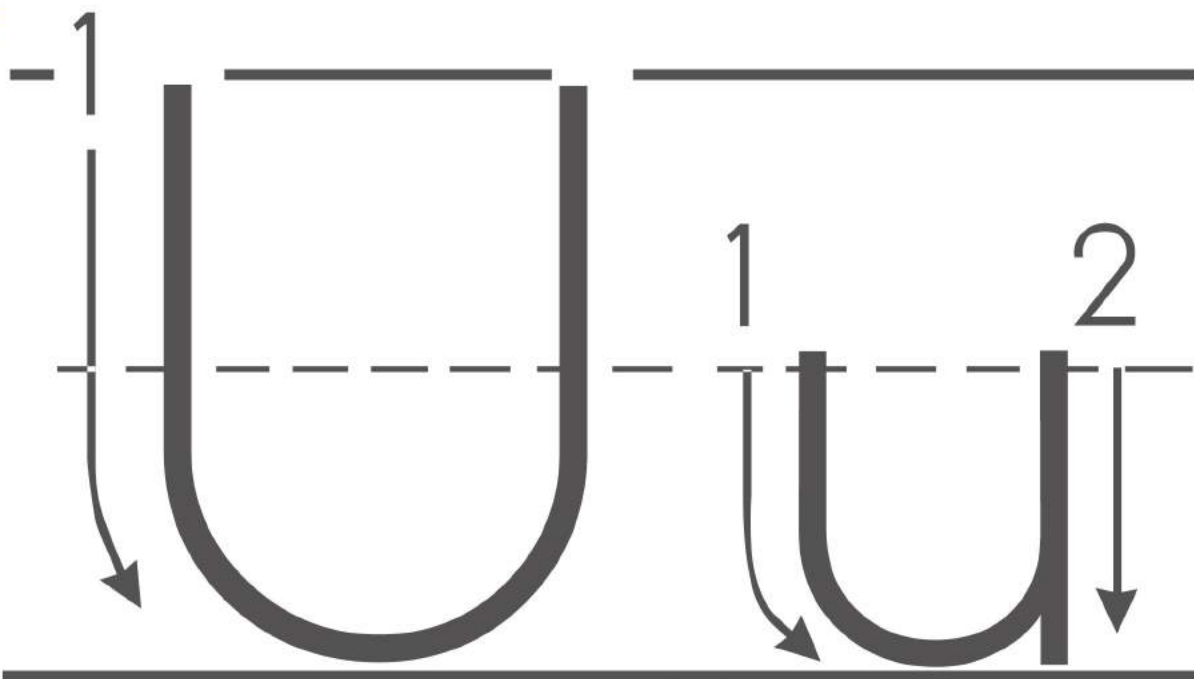

Come Down
U-Turn it
Back Around

Come Down
U-Turn it
Back Around
Line Down

Unicorn

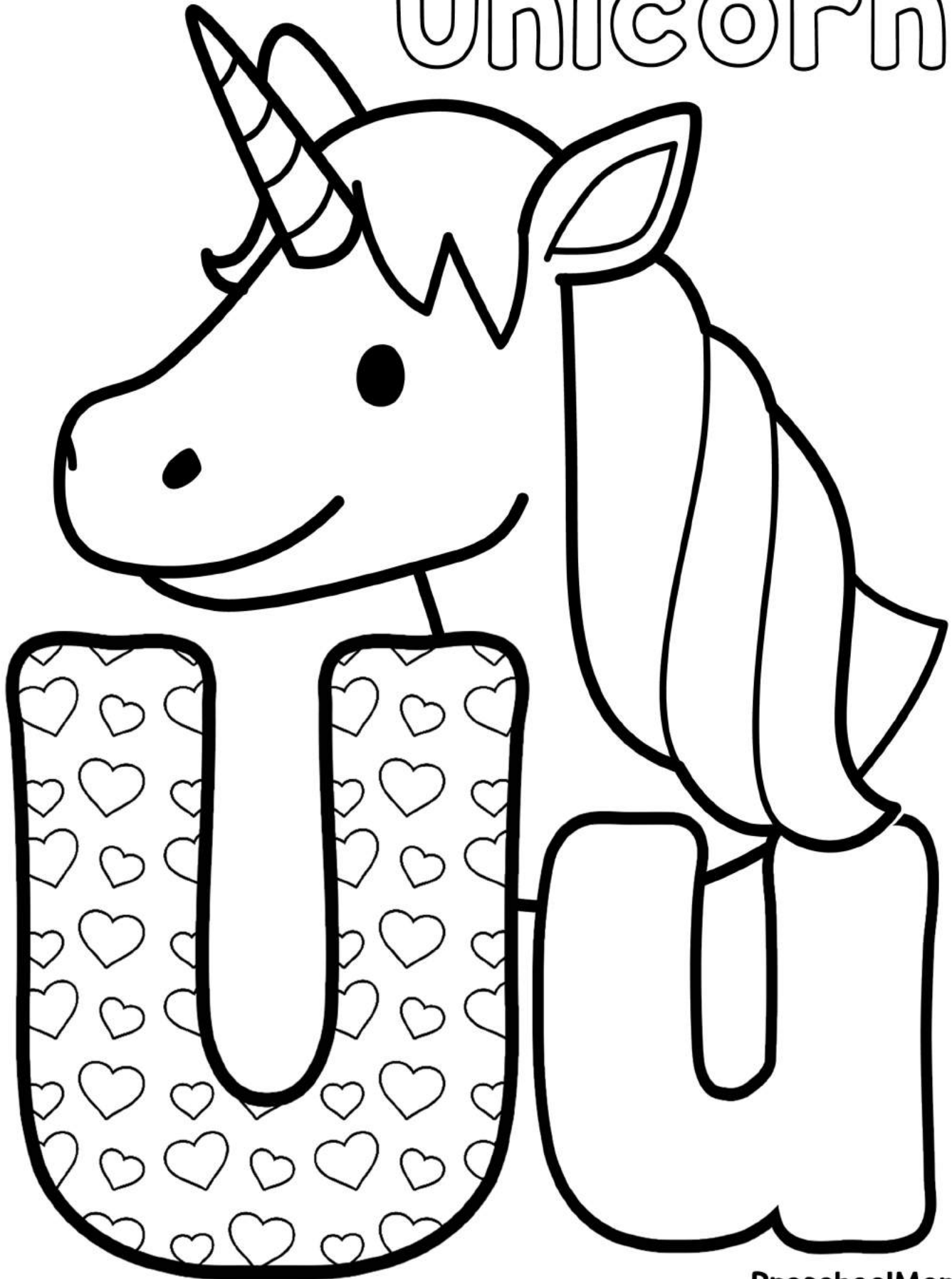

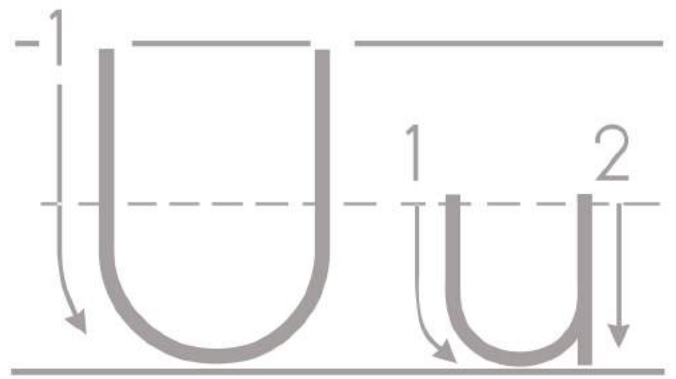

unicorn uncle unicycle utensils up umbrella

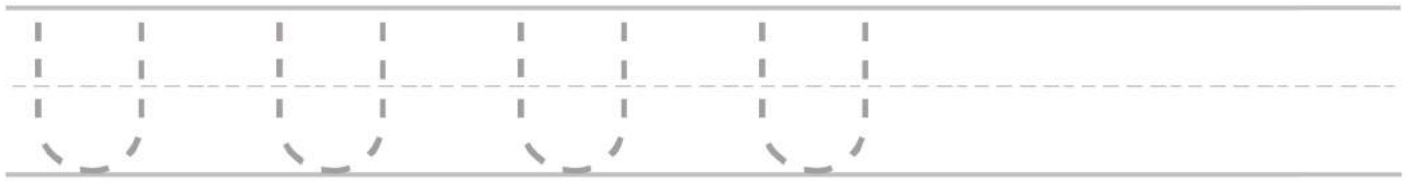
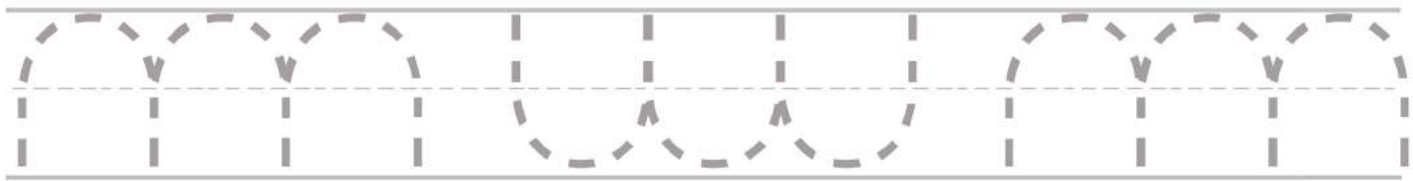

Uu

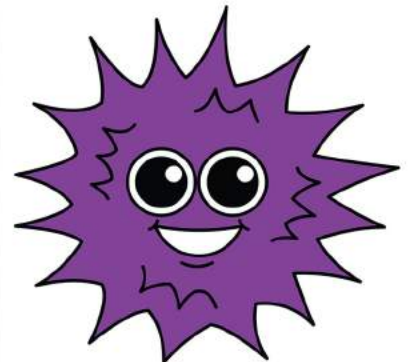
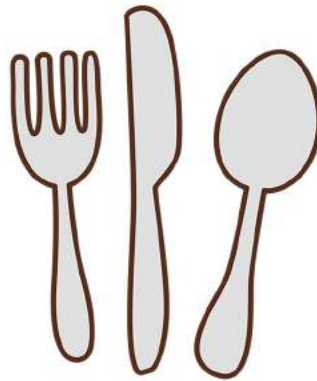
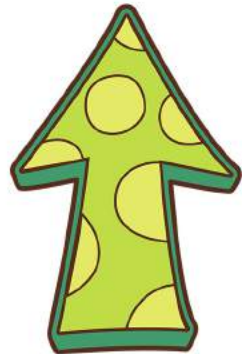
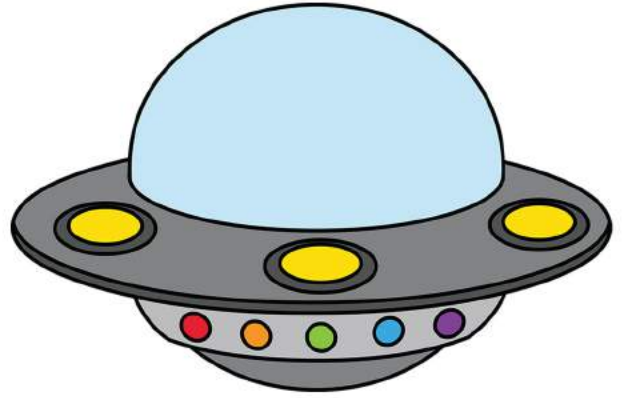

I CAN COLOR

 = umbrella

 = up

 = unicorn

 = ukulele

 = unicycle

 = utensils

 = uncle

words with:

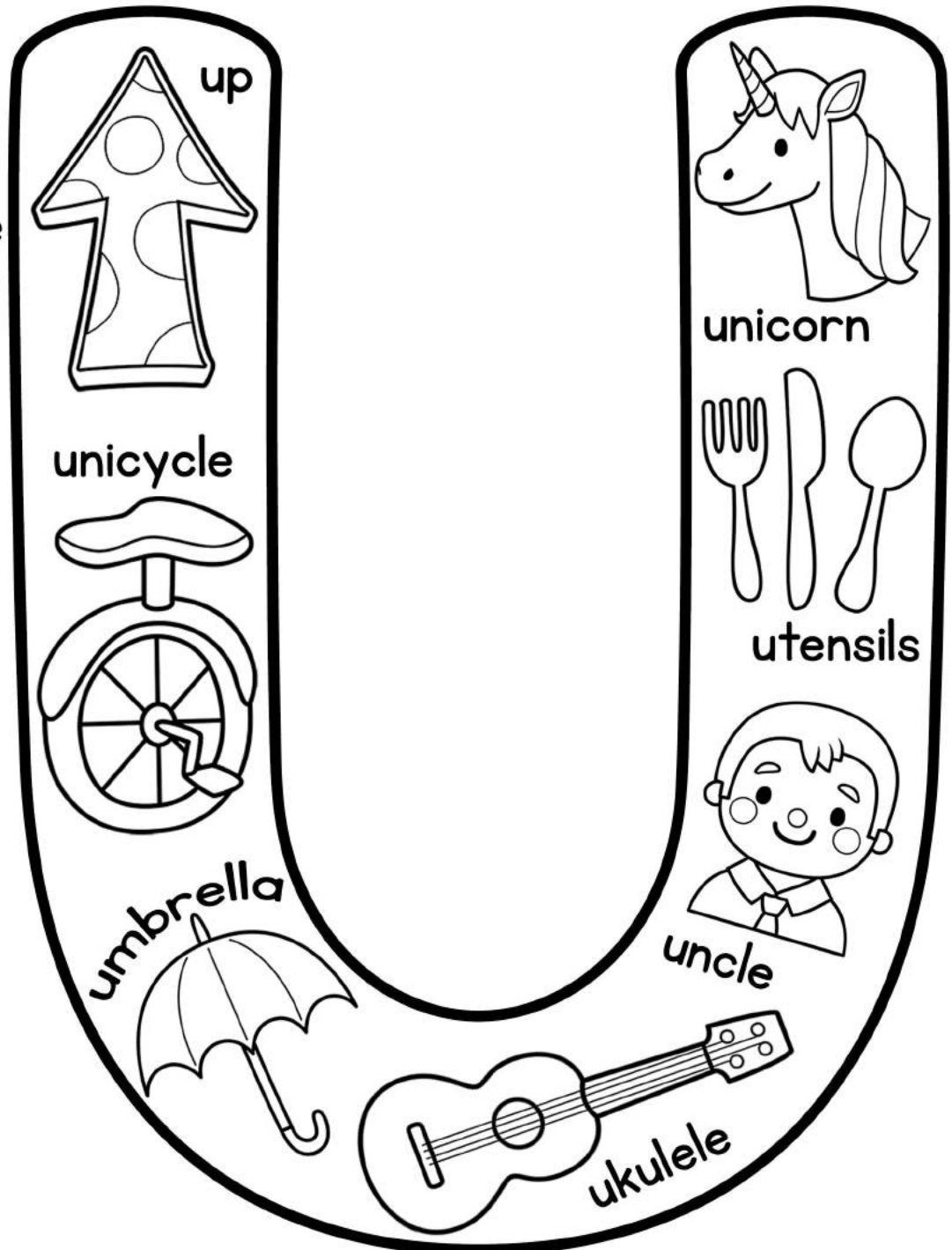

NAME : _____

Uu

Write and read words that begin with letter u.



up up up up



umbrella

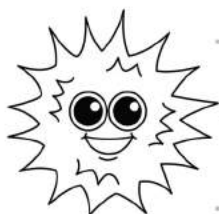

urchin urchin



uniform



unicycle

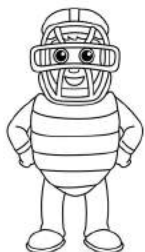

umpire



unicorn

NAME : _____

Uu

Write and read words that begin with letter u.



up up up



Umbrella

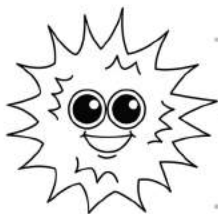

Urchin Urchin



Uniform



Unicycle

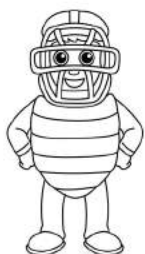

Umpire



Unicorn

NAME : _____

RACE TO THE TOP

Use a paperclip and a pencil to complete the spinner.

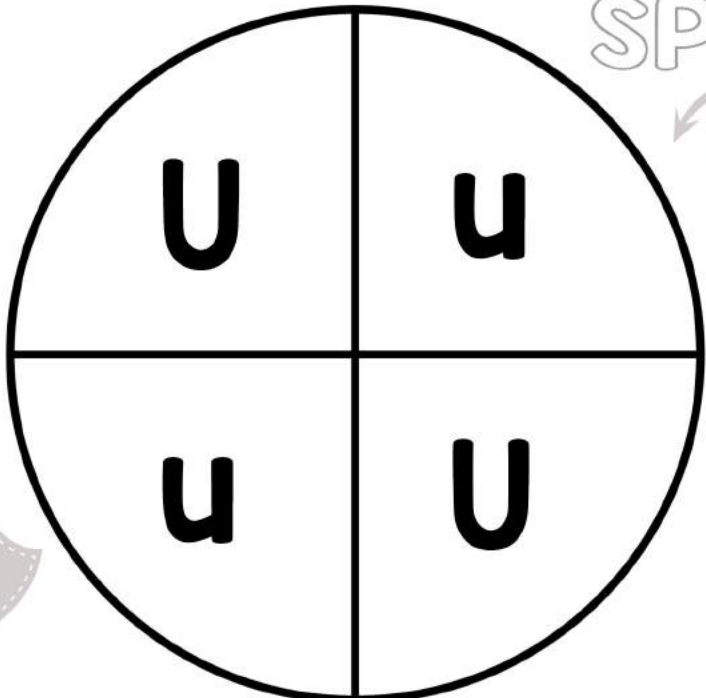

SPIN

Record

Report:

How many spins landed on U?

How many spins landed on u?

Which had more?

Write an inequality: >

How many spins total?

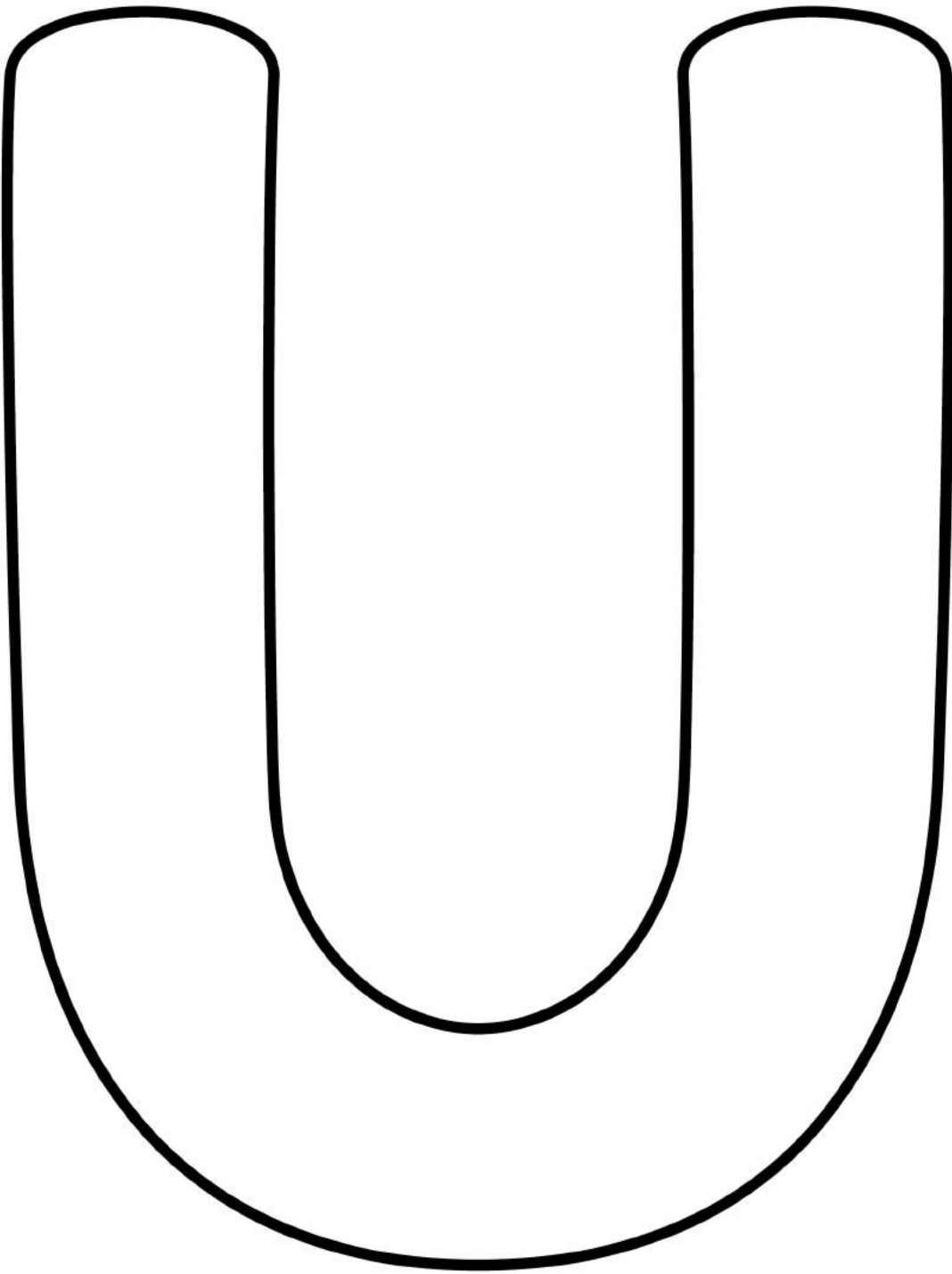

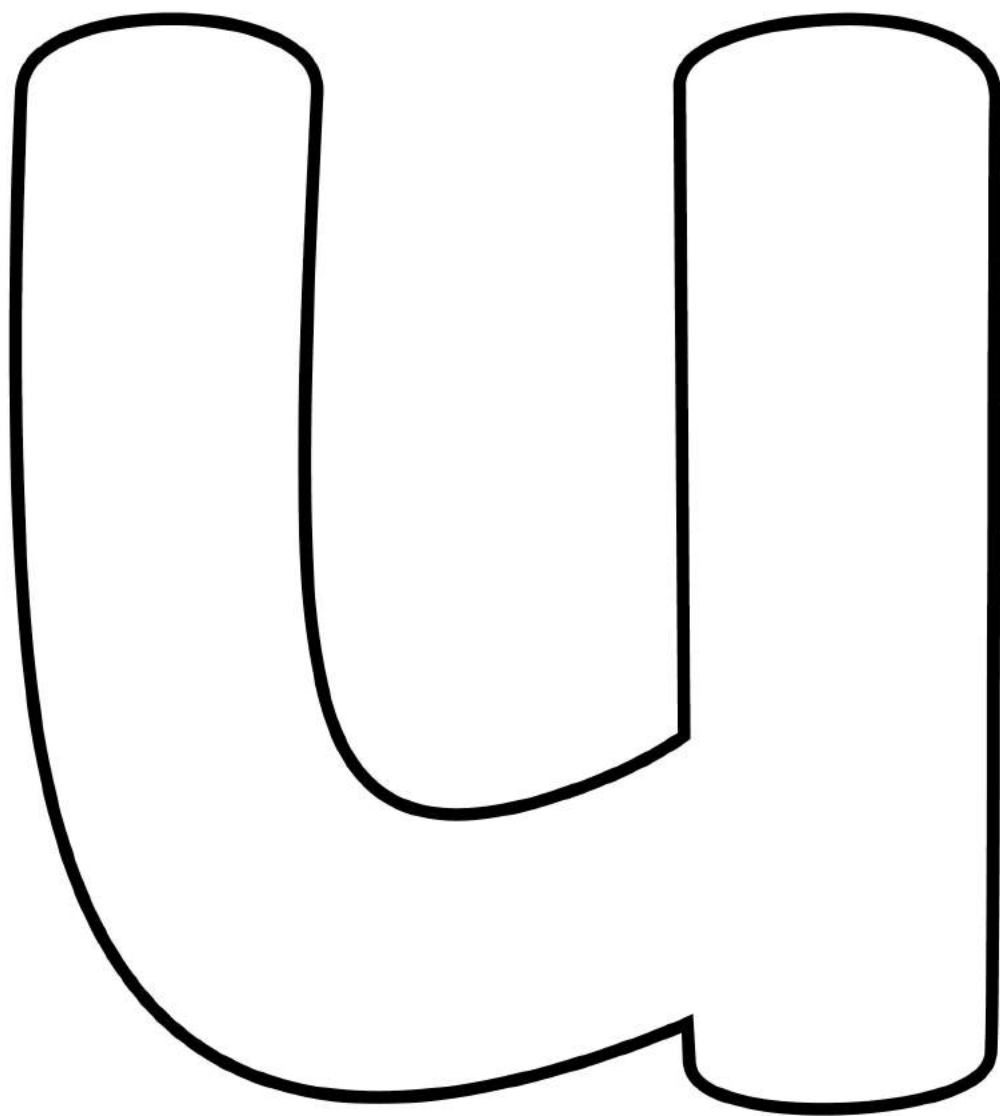

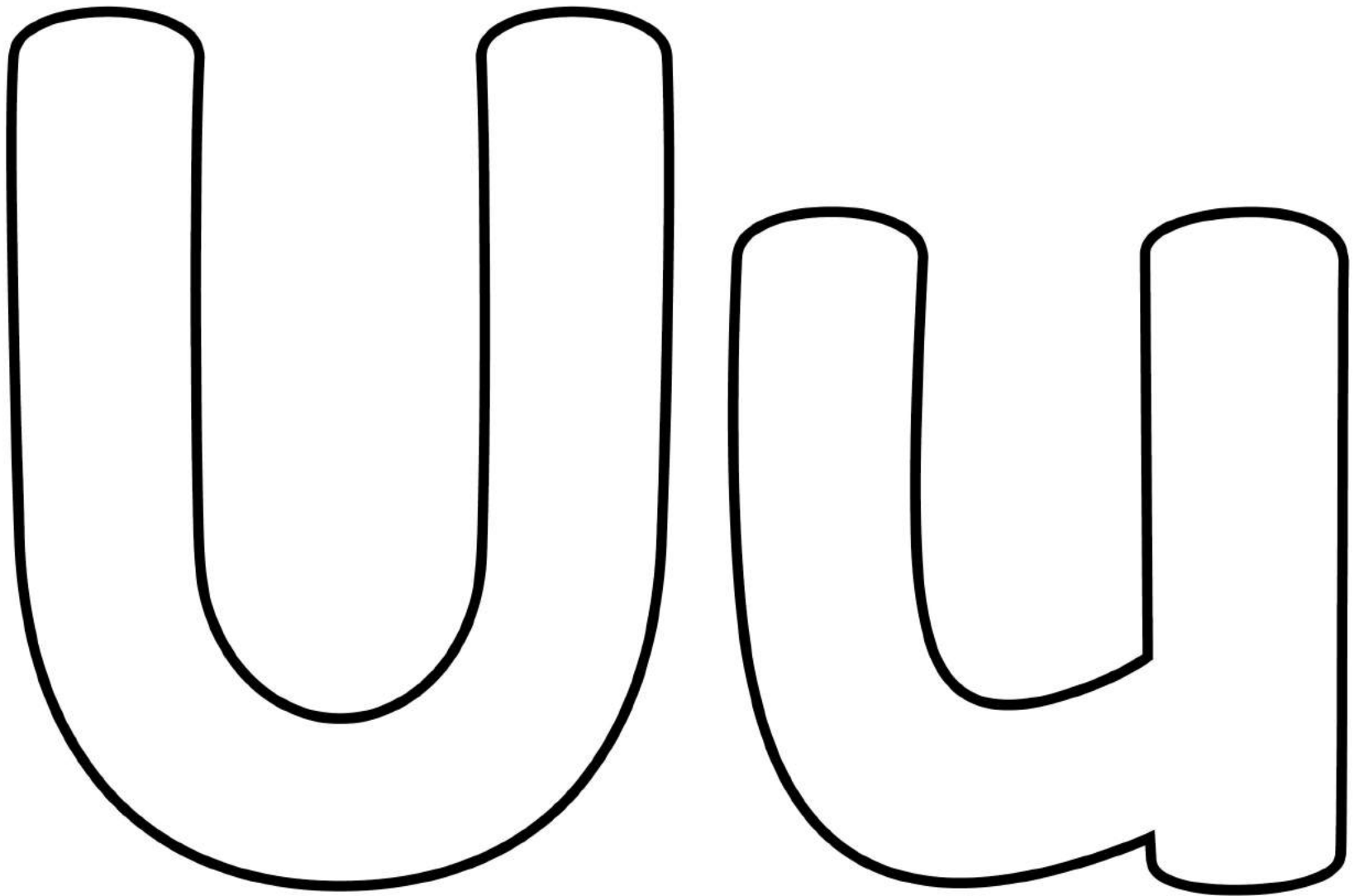

★ I ★

★ C ★ ★ A ★ ★ N ★

★ F ★ ★ I ★ ★ N ★ ★ D ★

the letter:

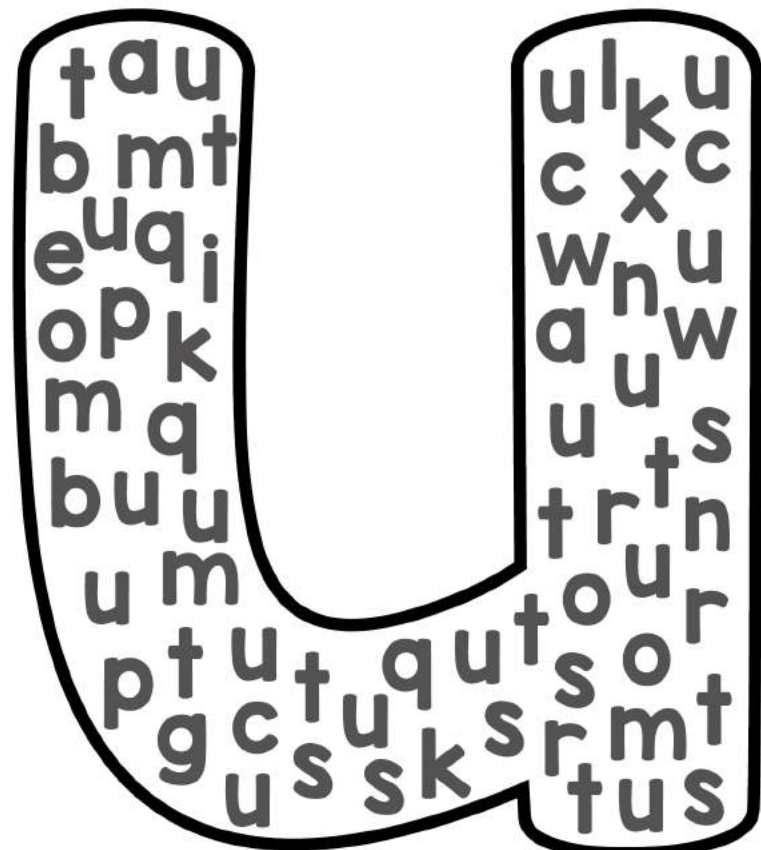
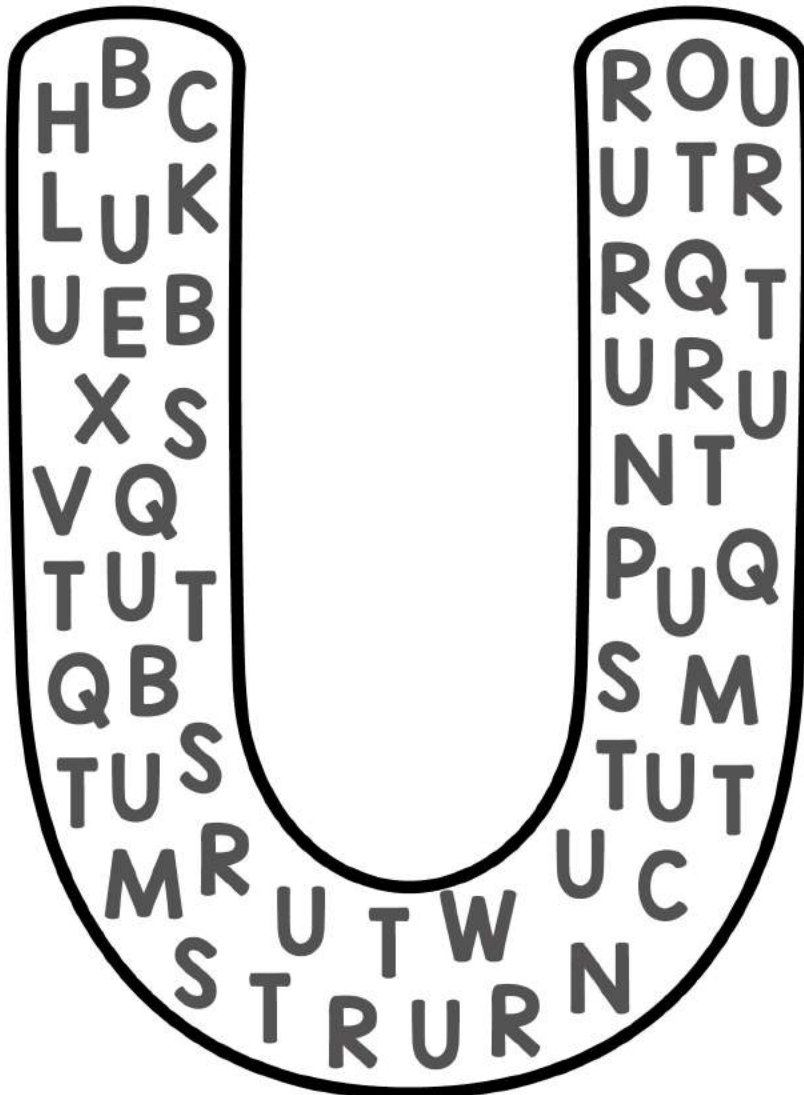

How Many?

How Many?

TRACE

NAME : _____







Color one for each row of letters you complete

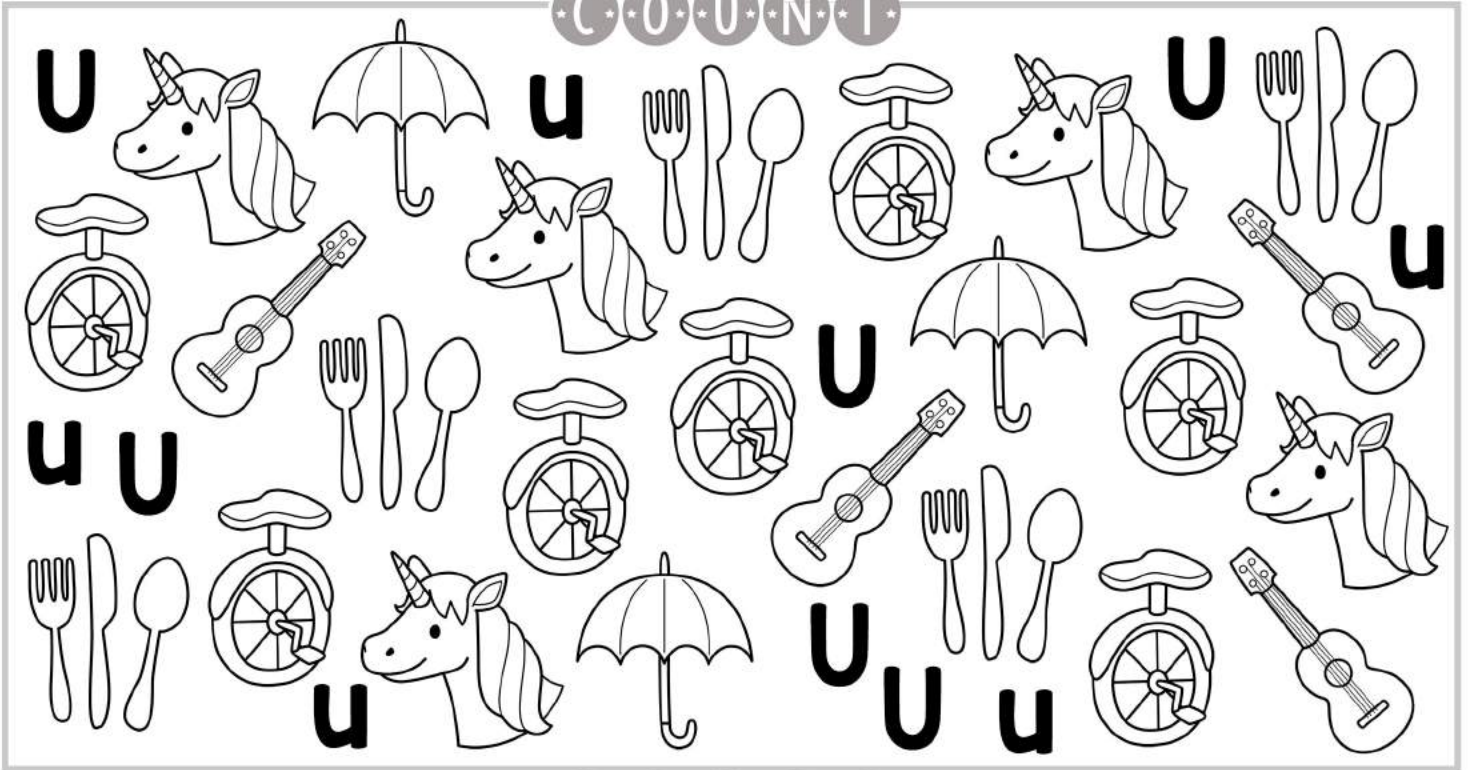

C · O · U · N · T



G · R · A · P · H

U	u					

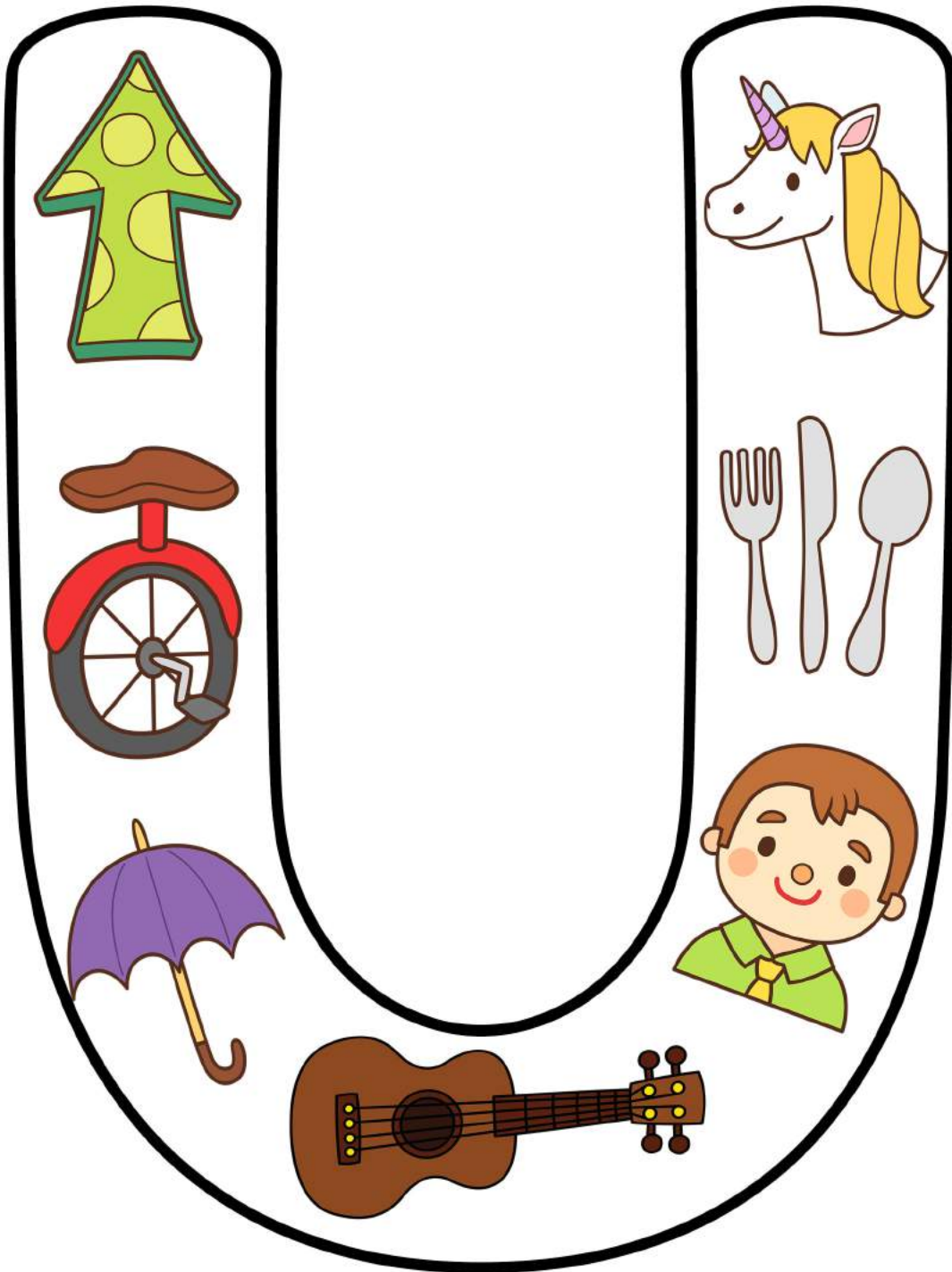

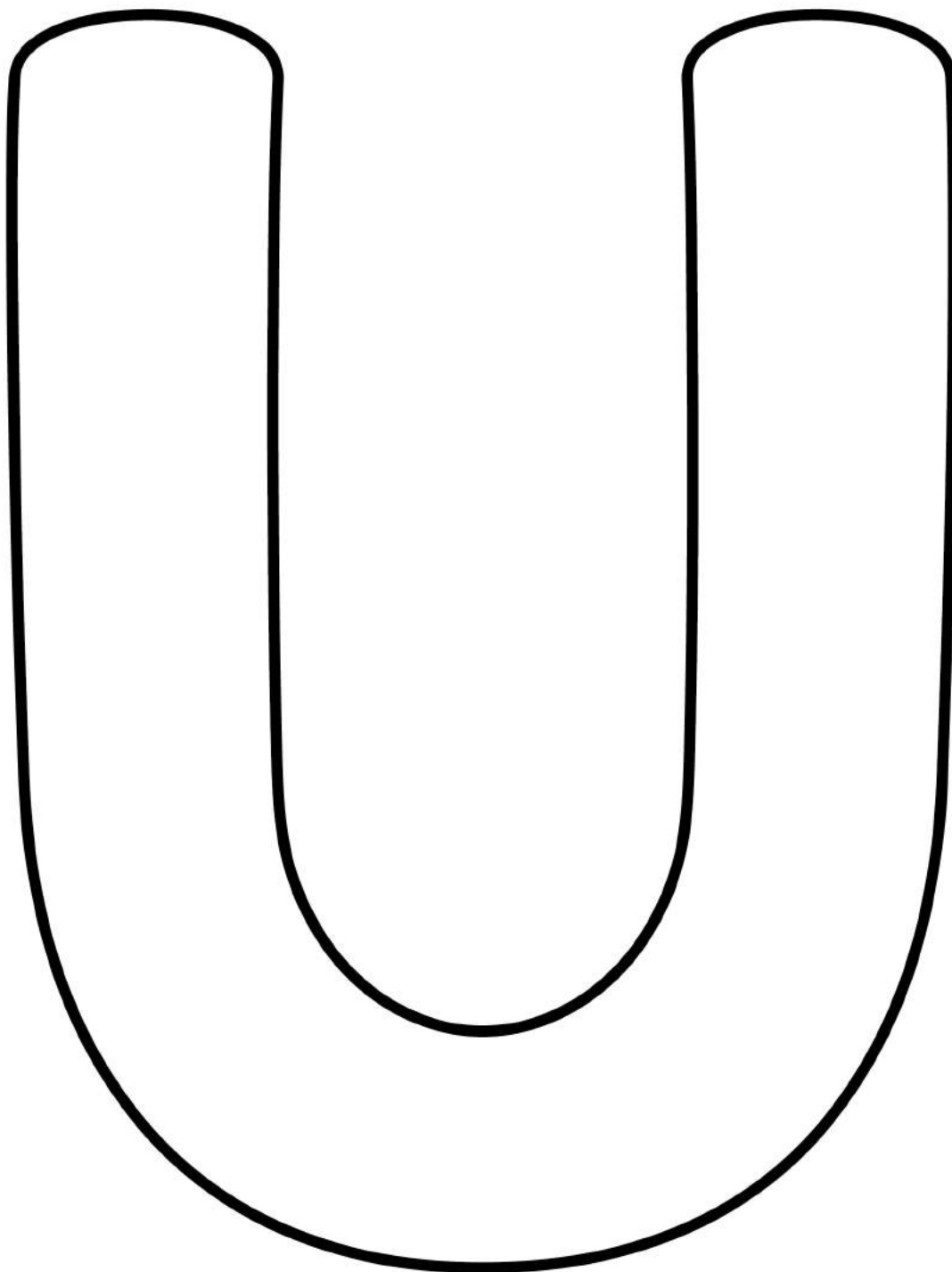

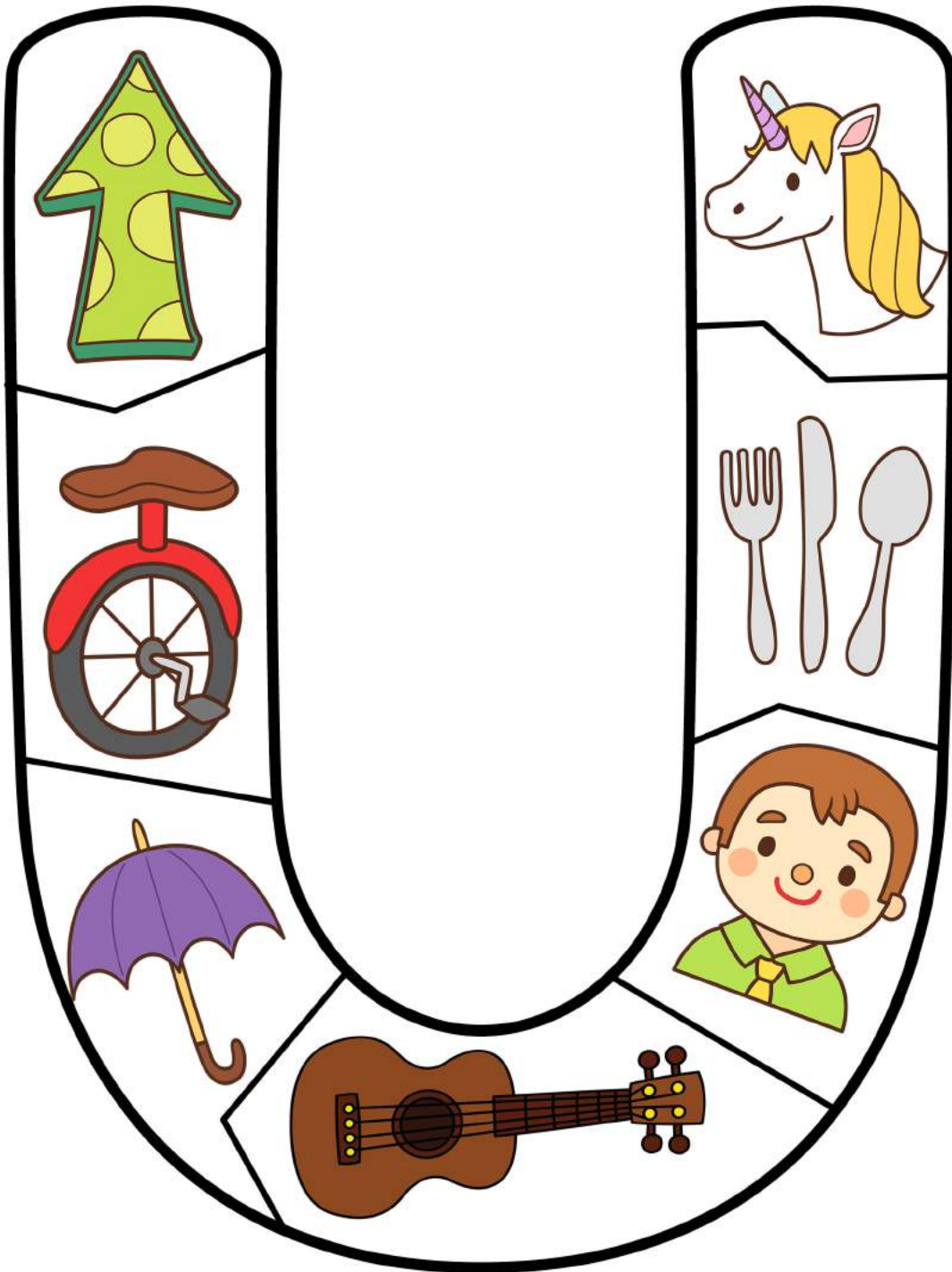

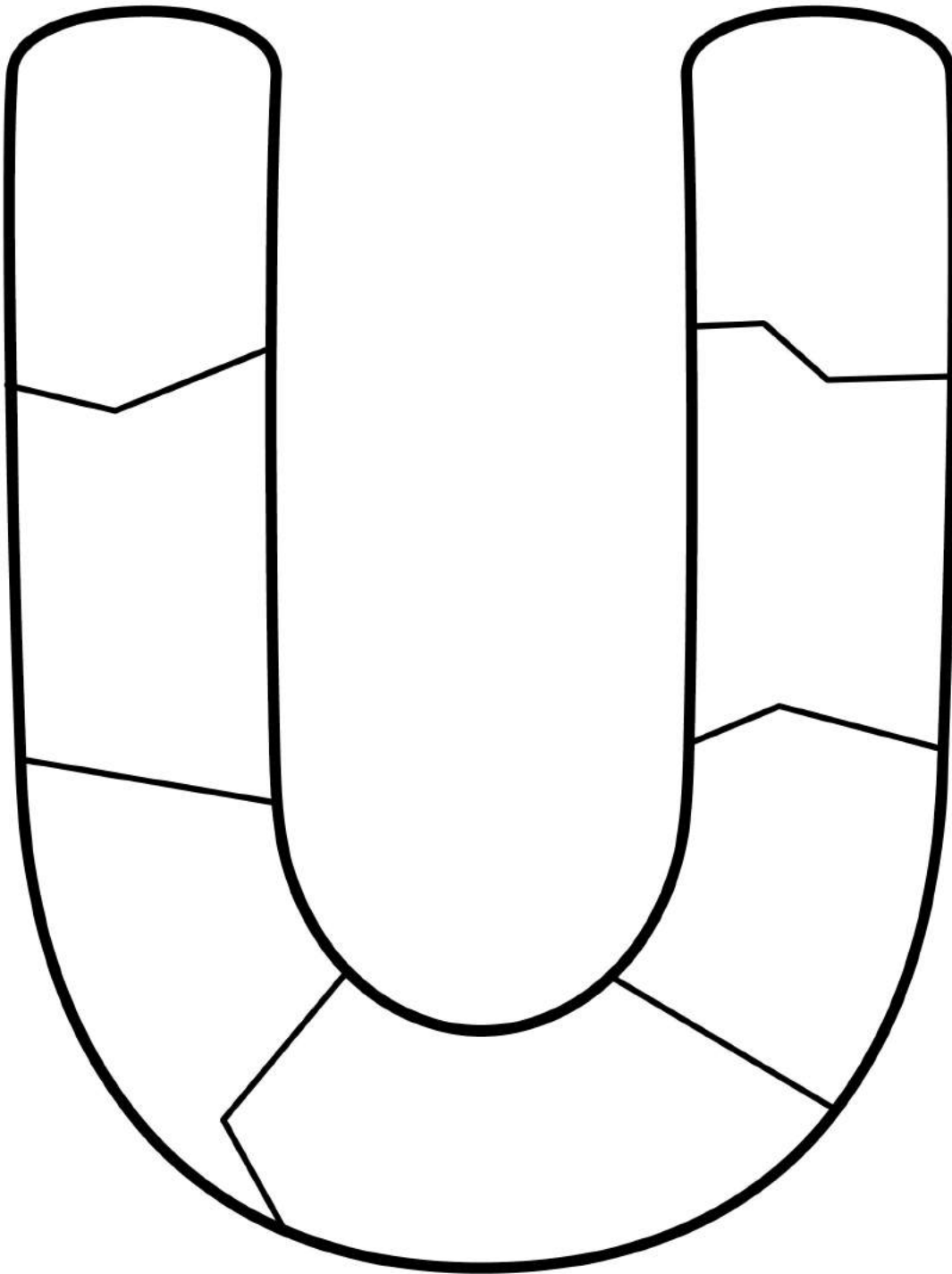

1. Write

2. Cut Out 

NAME : _____

U U

U U

U U

U U

U U

A B C Q U I L T

3. Color

4. Cut out 

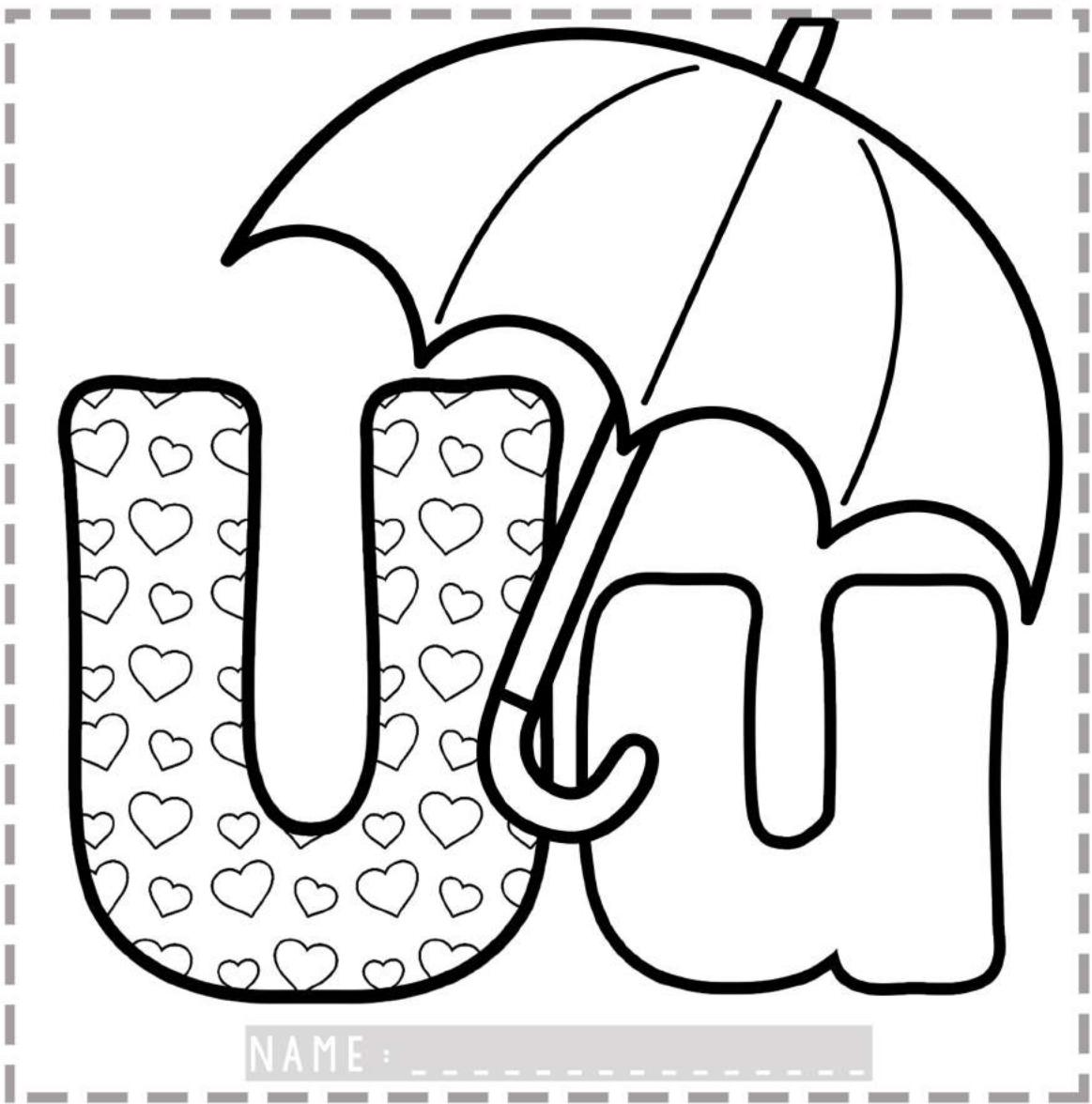

NAME : _____

Uu

Write and read words that begin with letter u.



umbrella



sun

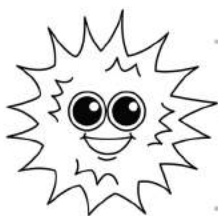

uniform



unicycle



bee

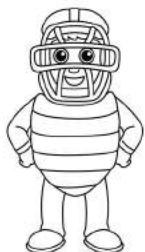

unicorn



unicorn



unicycle



unicorn

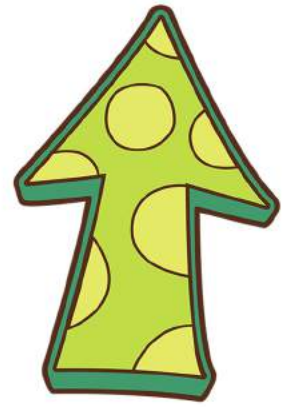

up

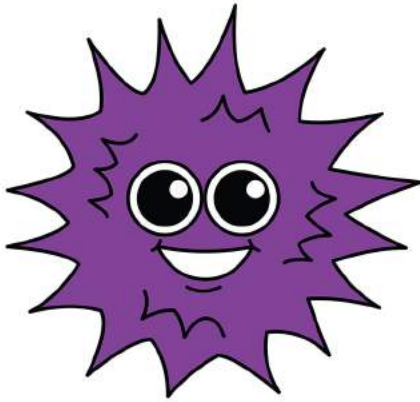

urchin

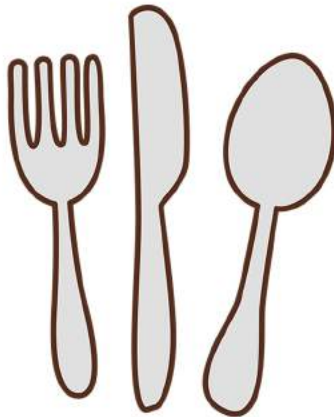

utensils



uniform



umpire



umbrella



ukulele

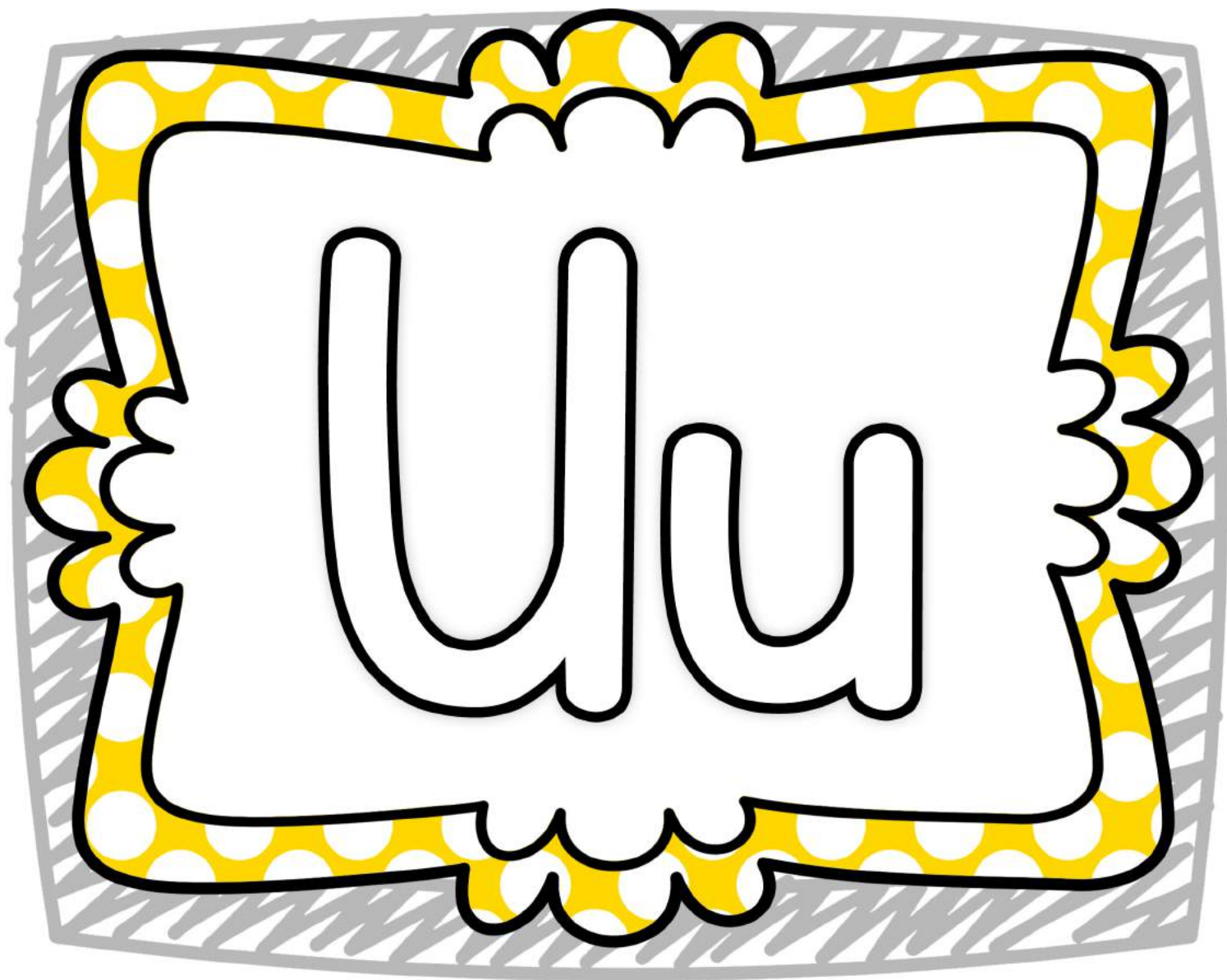

LETTER U



4 IN A ROW

LETTER U



4 IN A ROW

LETTER U



4 IN A ROW

LETTER U



4 IN A ROW

Images (c) Little Red's Clipart, Zip-a-De-Doo-Dah Designs & Miss Giraffe

I C A N W R I T E

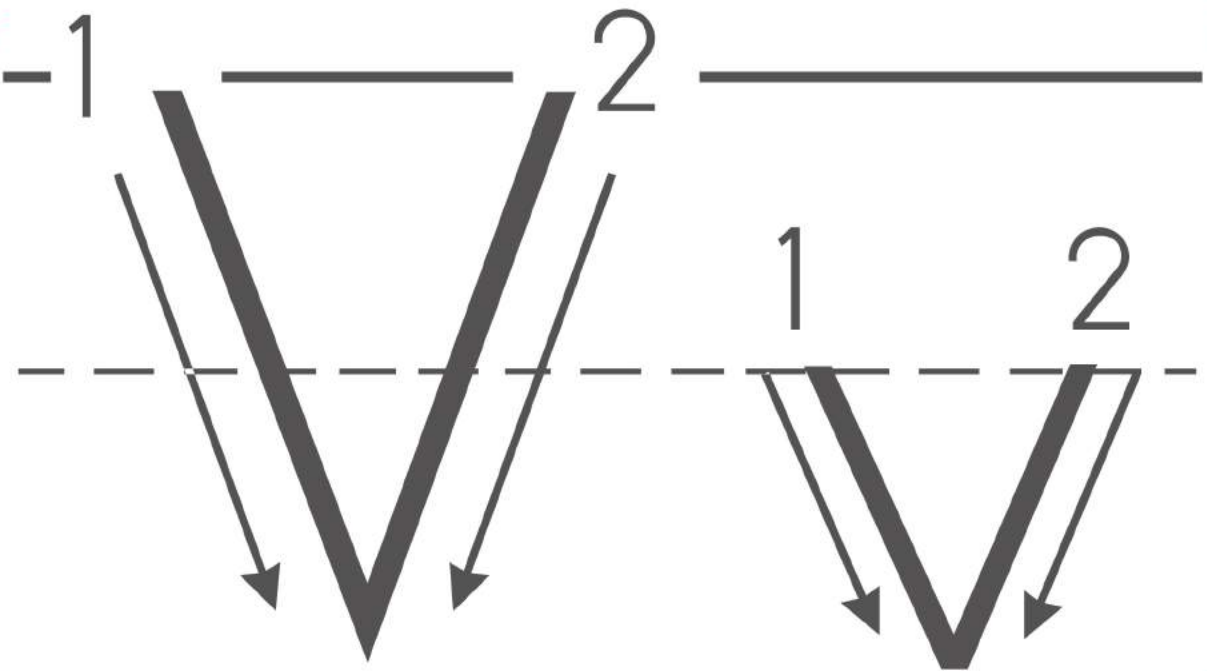

Slide Down
Pick up
Slide Down

Slide Down
Pick up
Slide Down

Vulture

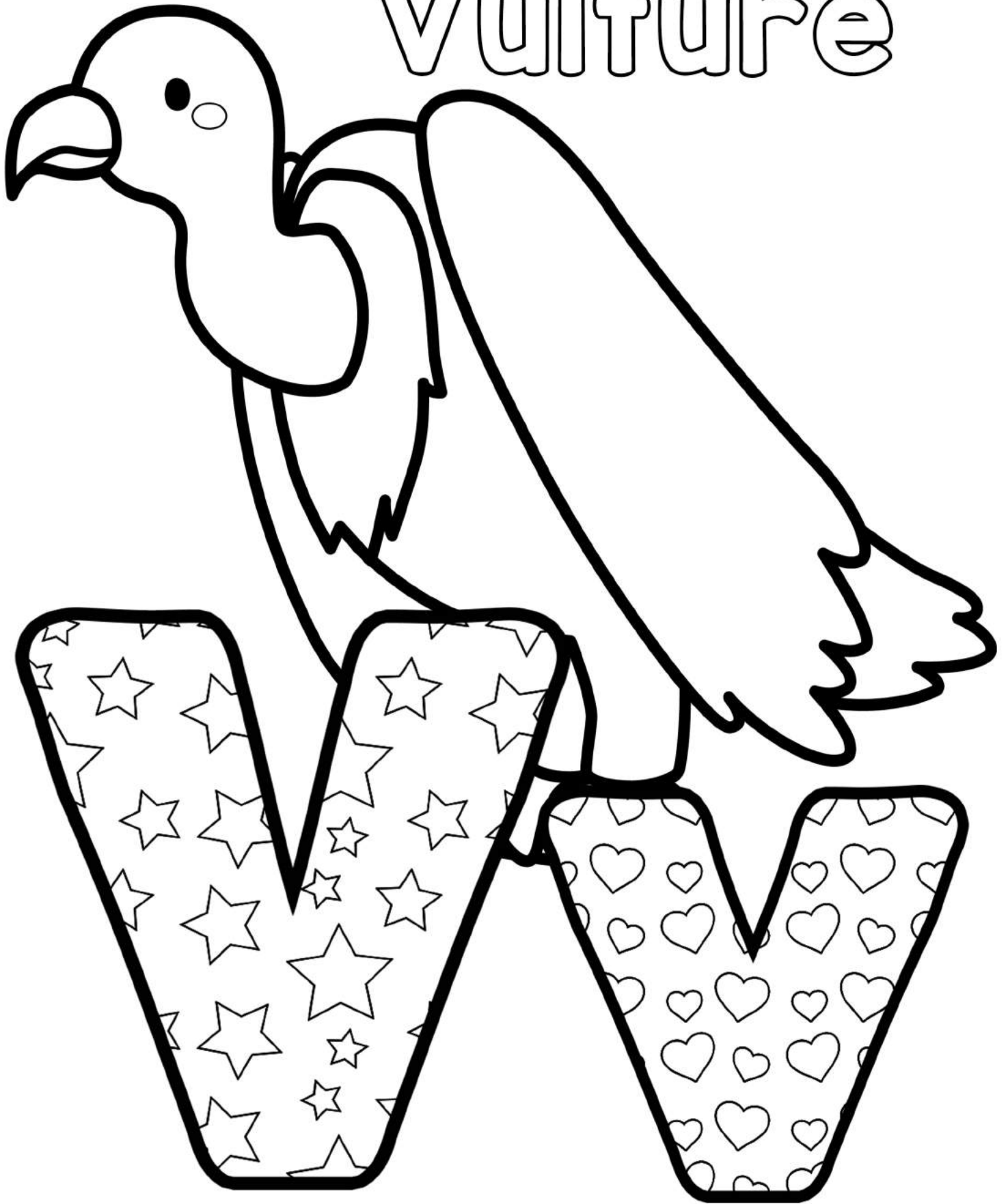

V

v

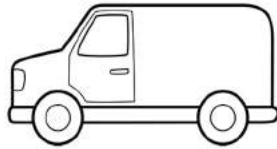
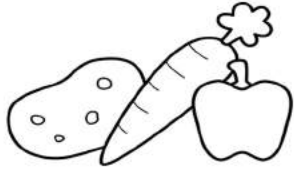
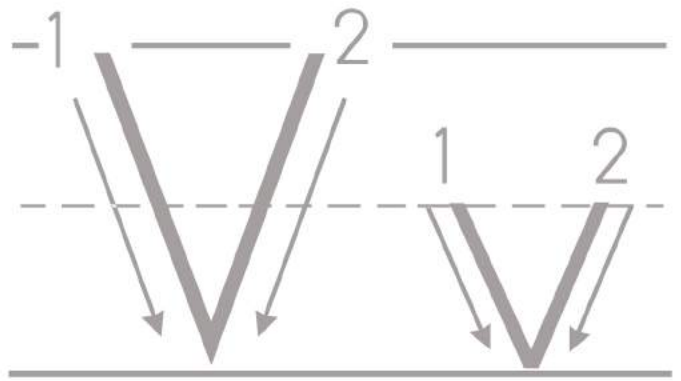

violin

vegetables

van

volcano

vase

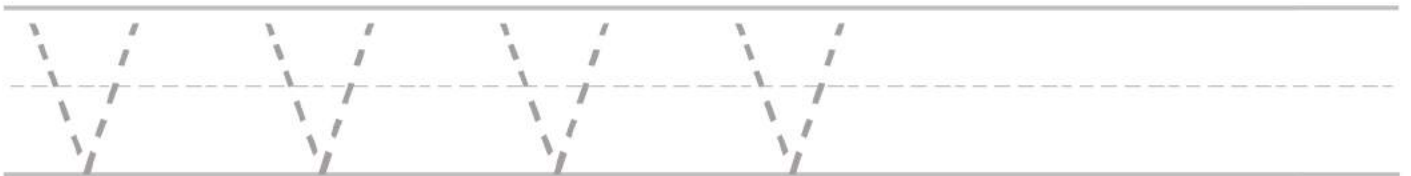

Match the valentines to make 10

Draw 11 flowers in the vase:

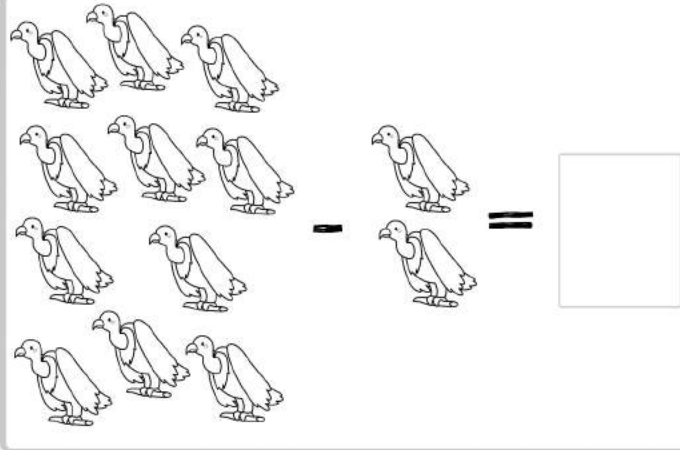
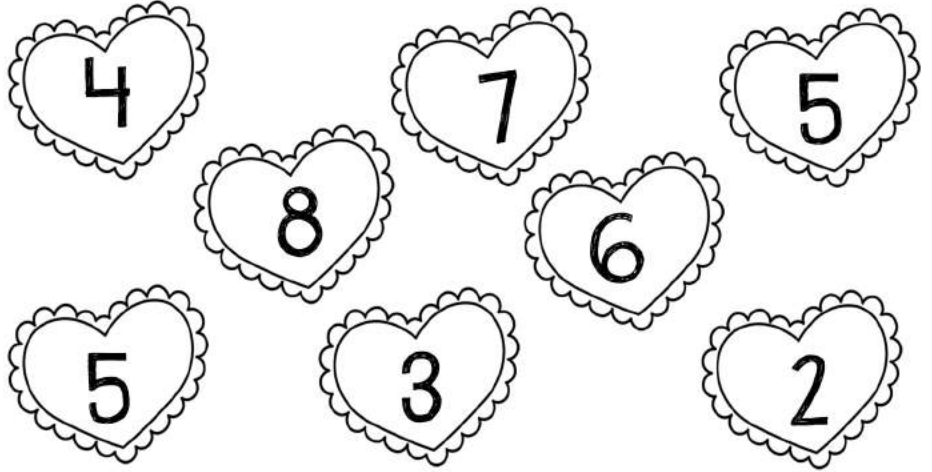

Count & Tally the vegetables:

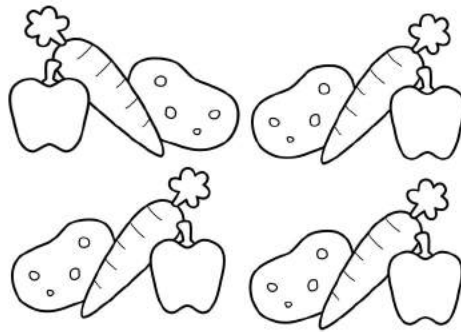

$$11 - 2 = \square$$

$$11 - 3 = \square$$

$$\begin{array}{r} 11 \\ - 4 \\ \hline \square \end{array} \quad \begin{array}{r} 11 \\ - 5 \\ \hline \square \end{array}$$

Circle groups of two volleyballs. Count by 2's

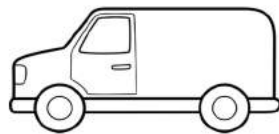
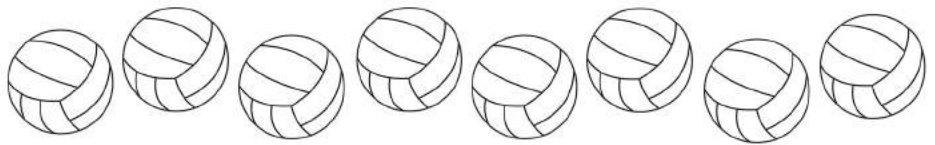

Valerie put 10 violins in the van. Then she took 2 back out. How many violins are left in the van?



Draw: $11 - 4 = 7$

$$\begin{array}{r} 11 \\ - 4 \\ \hline \square \end{array} = \square$$

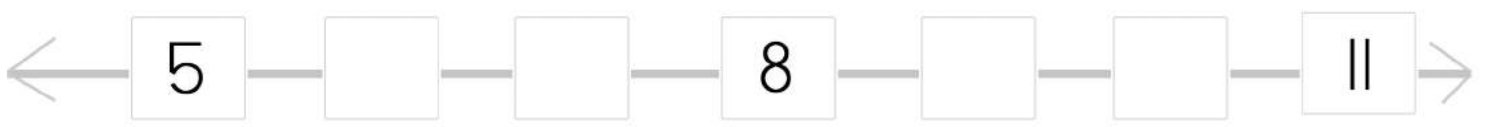

V v

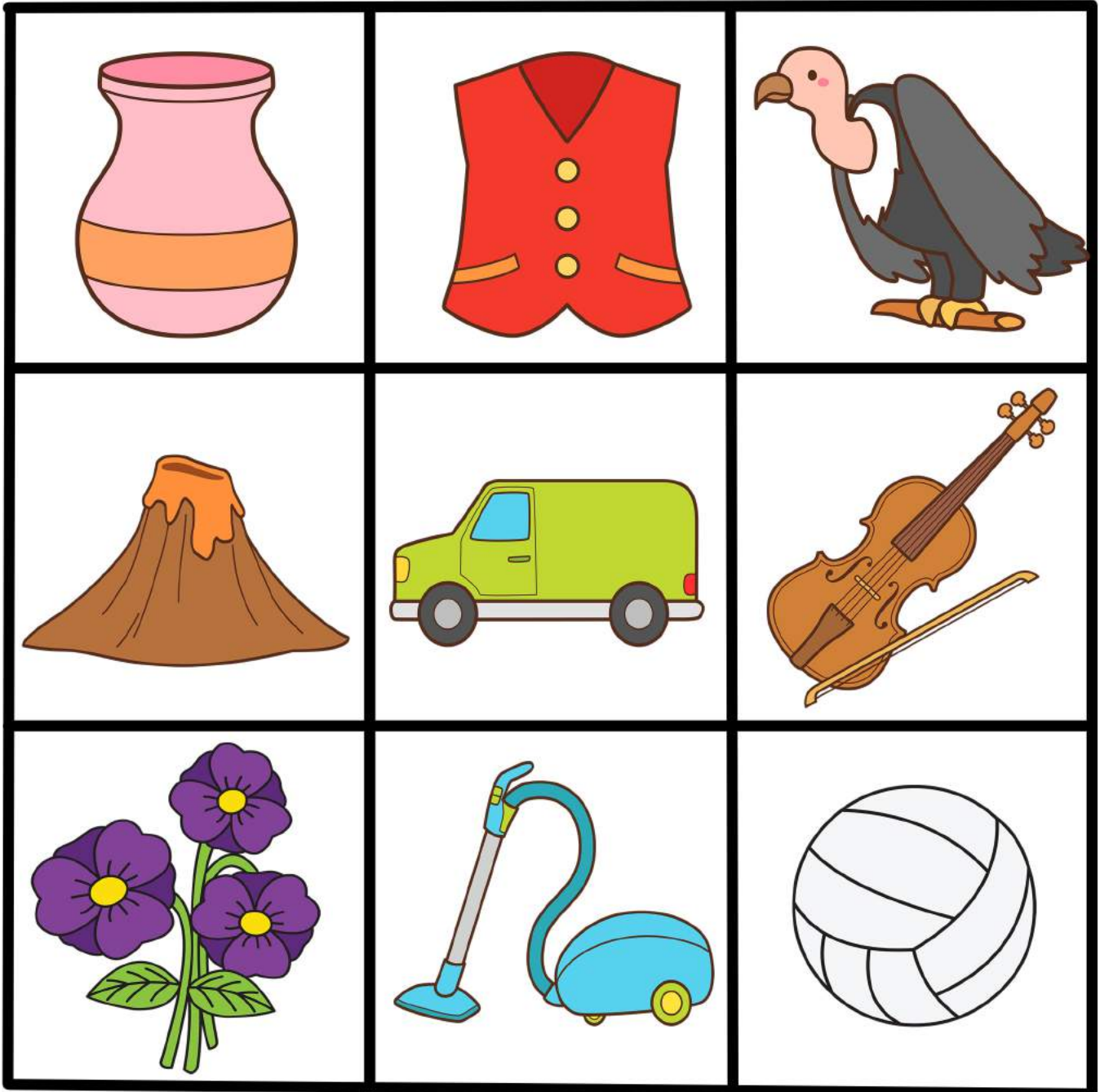
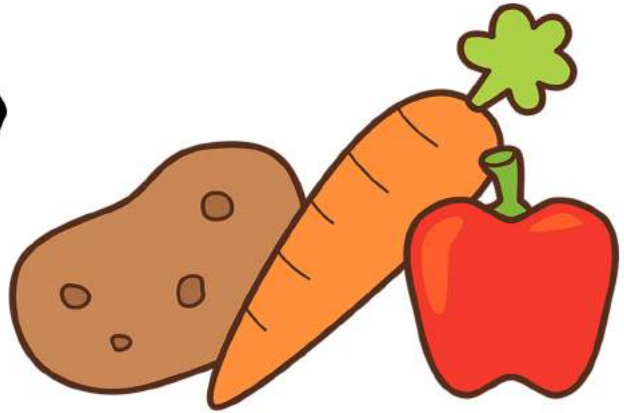

I C A N C O L O R

words with:

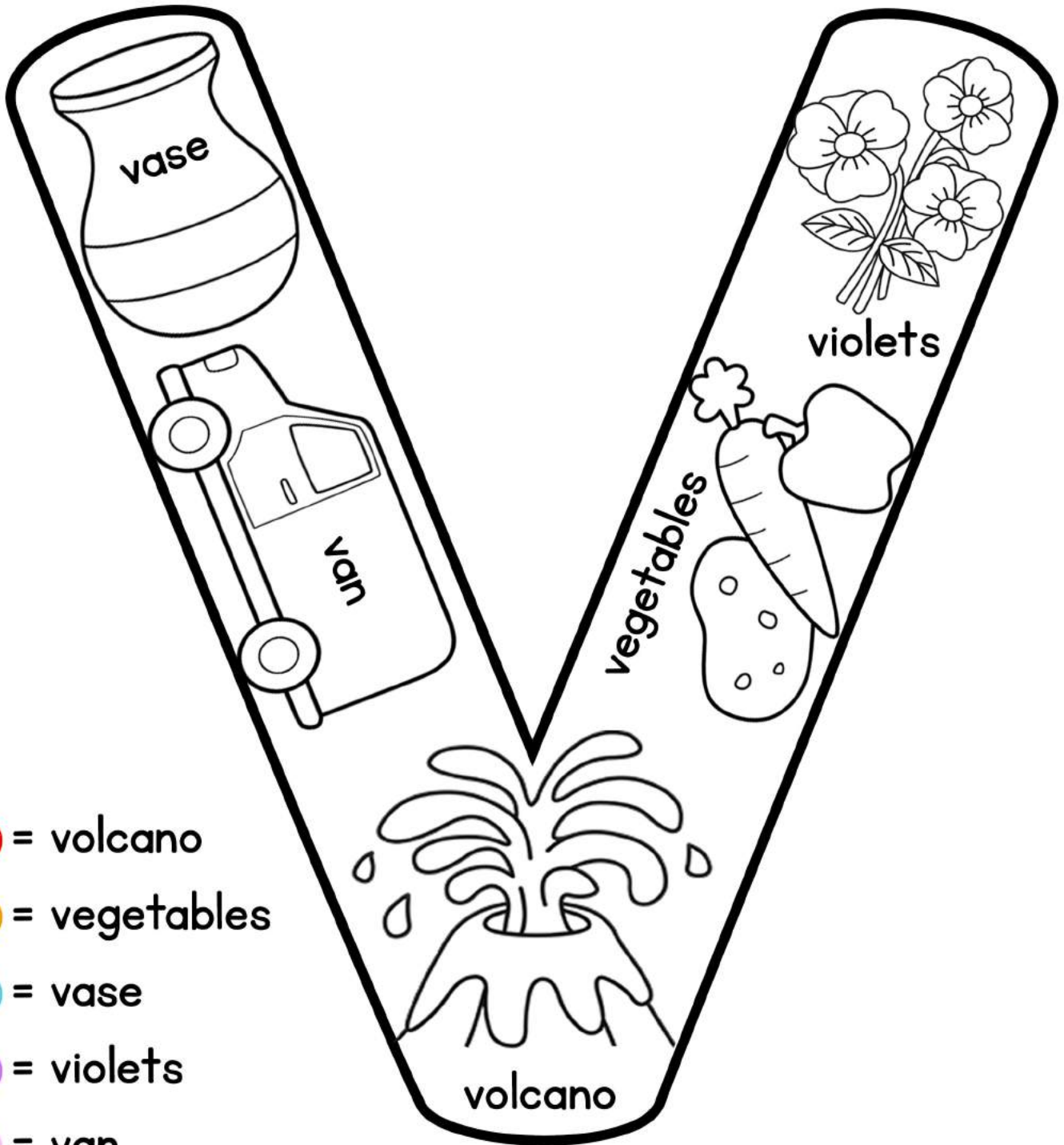

- = volcano
- = vegetables
- = vase
- = violets
- = van

NAME : _____

Vv

Write and read words that begin with letter v.



van van van



vase vase



vest vest

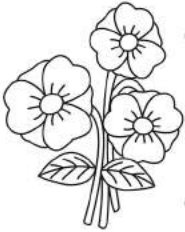

violets violets



violin violin



vulture



volcano

NAME : _____

Vv

Write and read words that begin with letter v.



Van Van



Vase Vase



Vest Vest

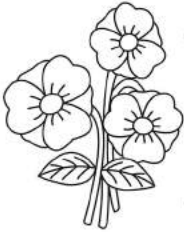

Violets



Violin Violin



Vulture



Volcano

NAME : _____

RACE TO THE TOP

Use a paperclip and a pencil to complete the spinner.

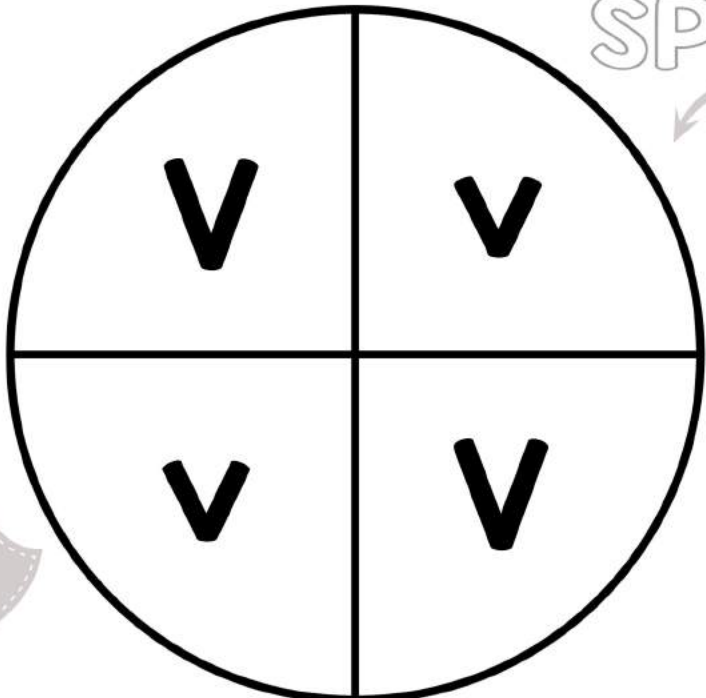

SPIN

Record

Report:

How many spins landed on V?

How many spins landed on v?

Which had more?

Write an inequality: **>**

How many spins total?

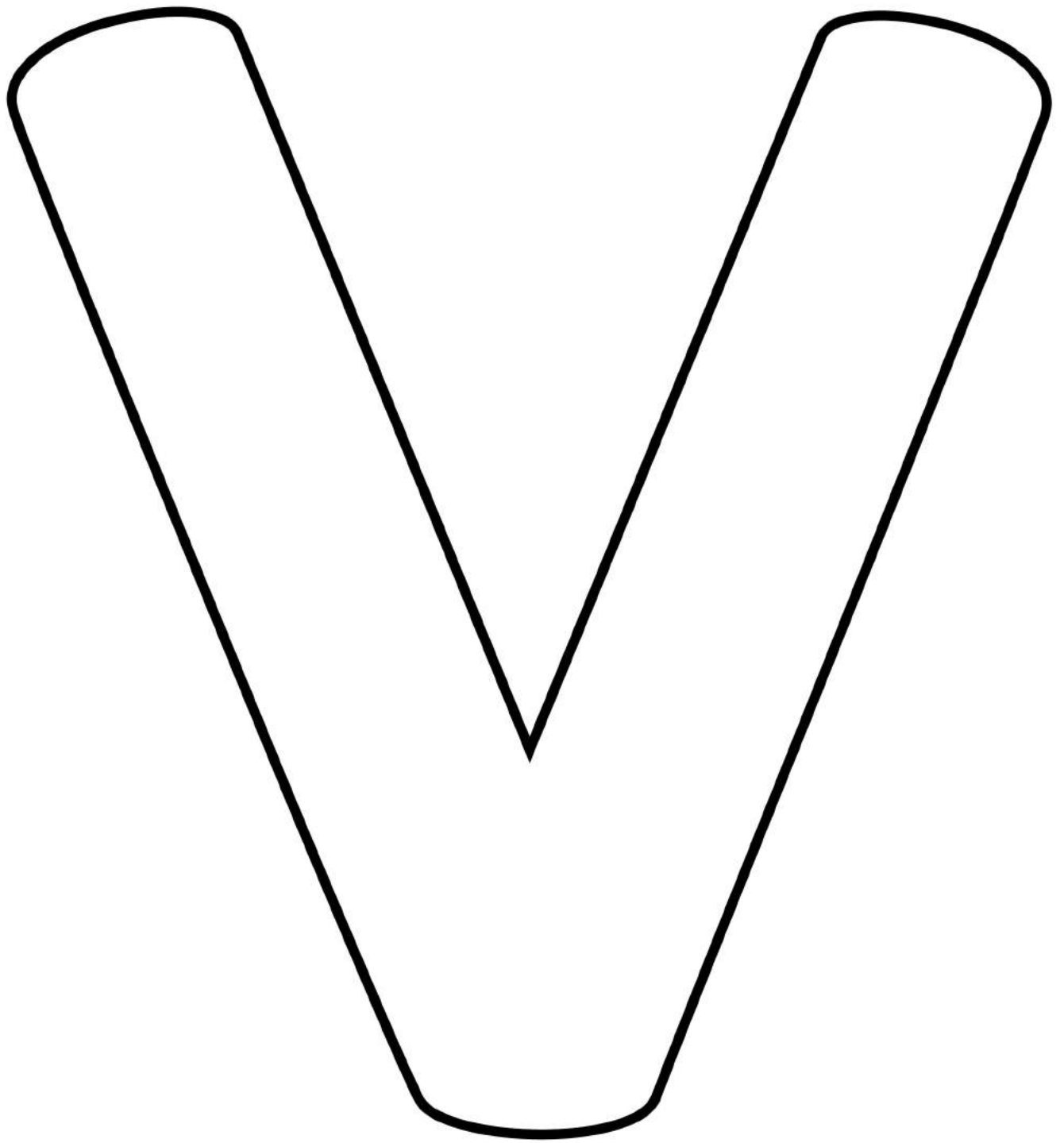





TRACE

NAME : _____

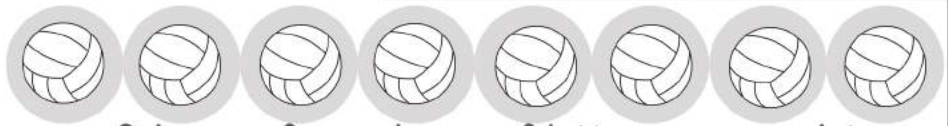



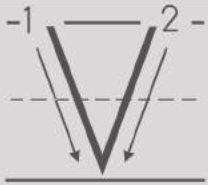

Color one for each row of letters you complete

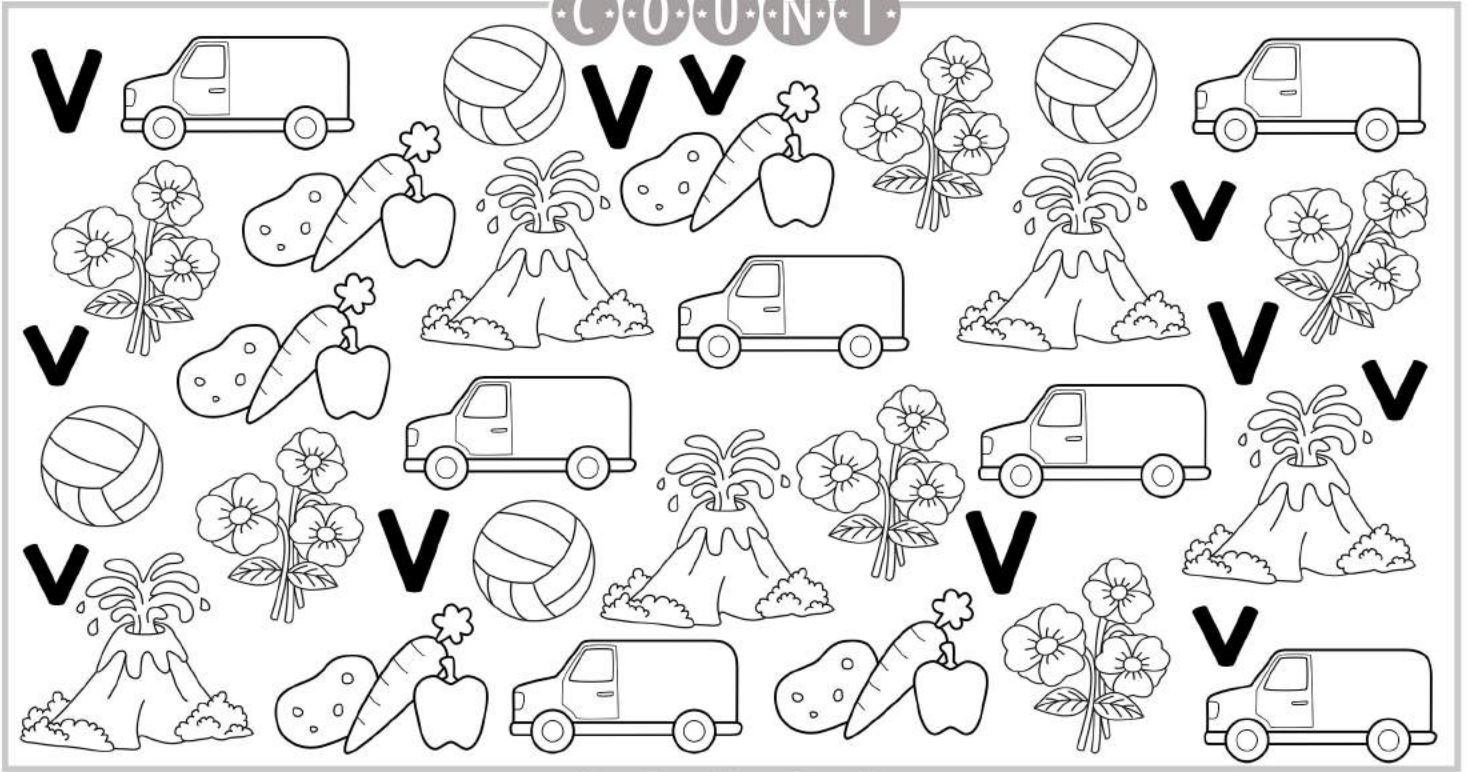

C · O · U · N · T



G · R · A · P · H

V	v					

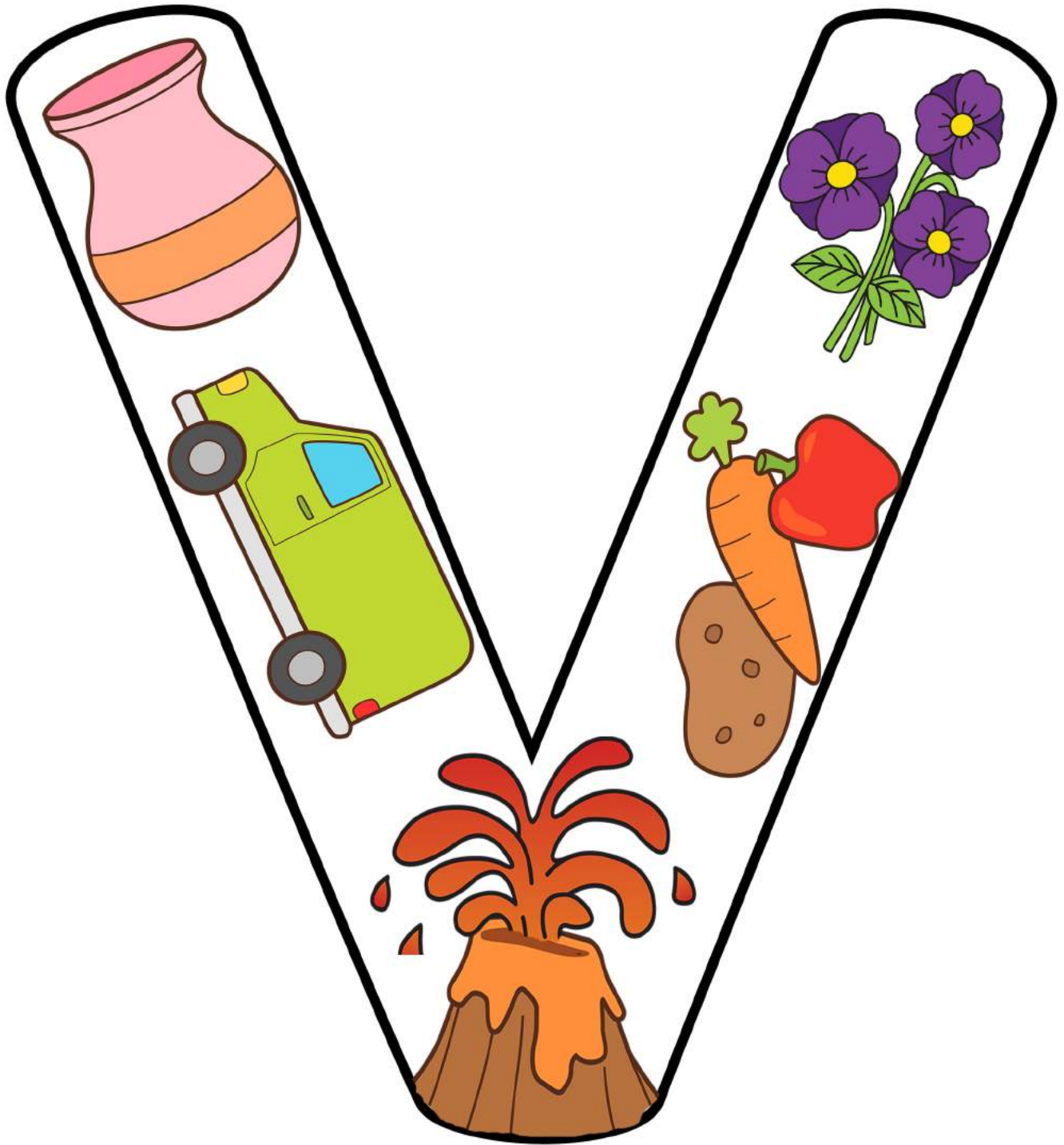

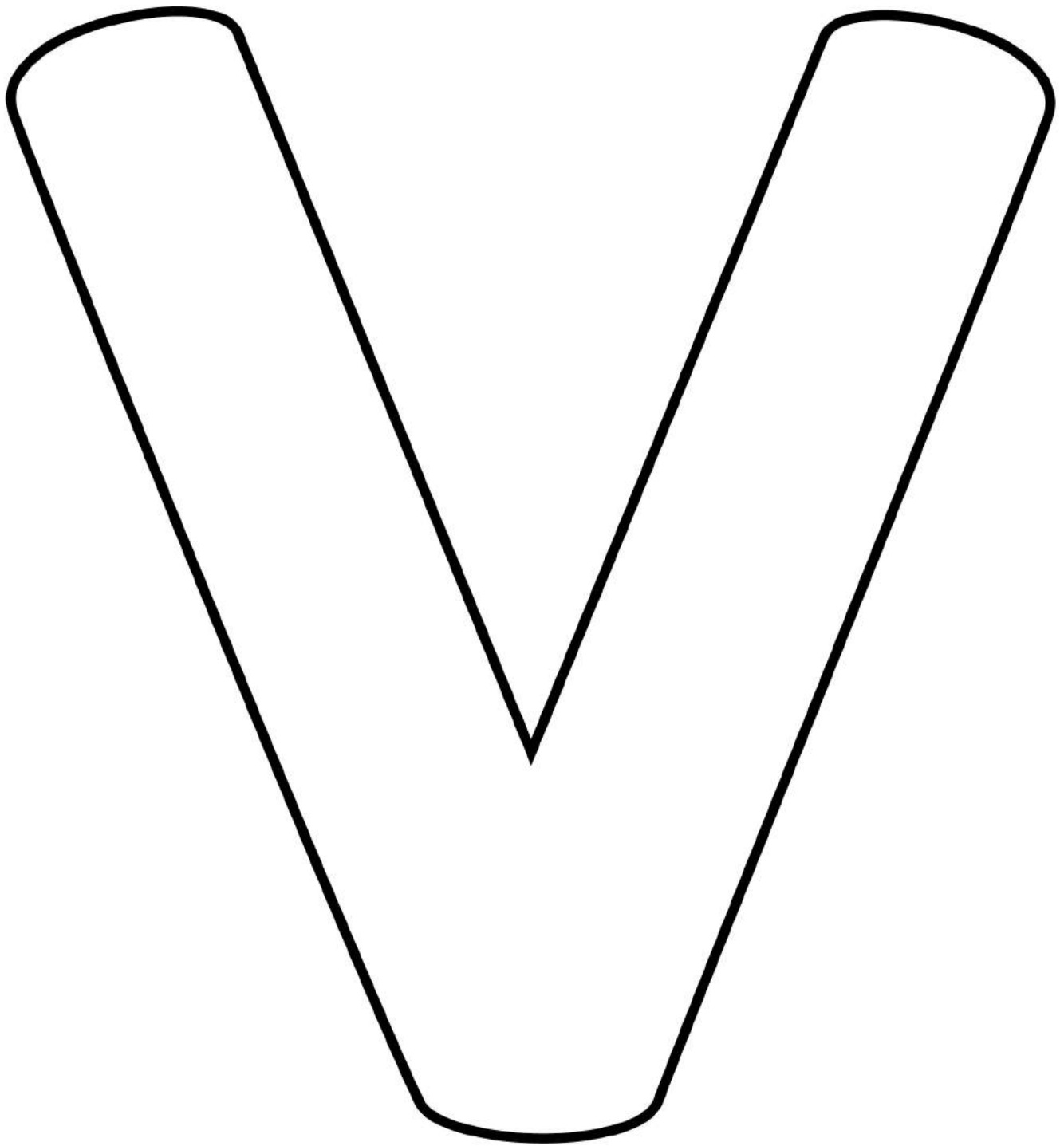

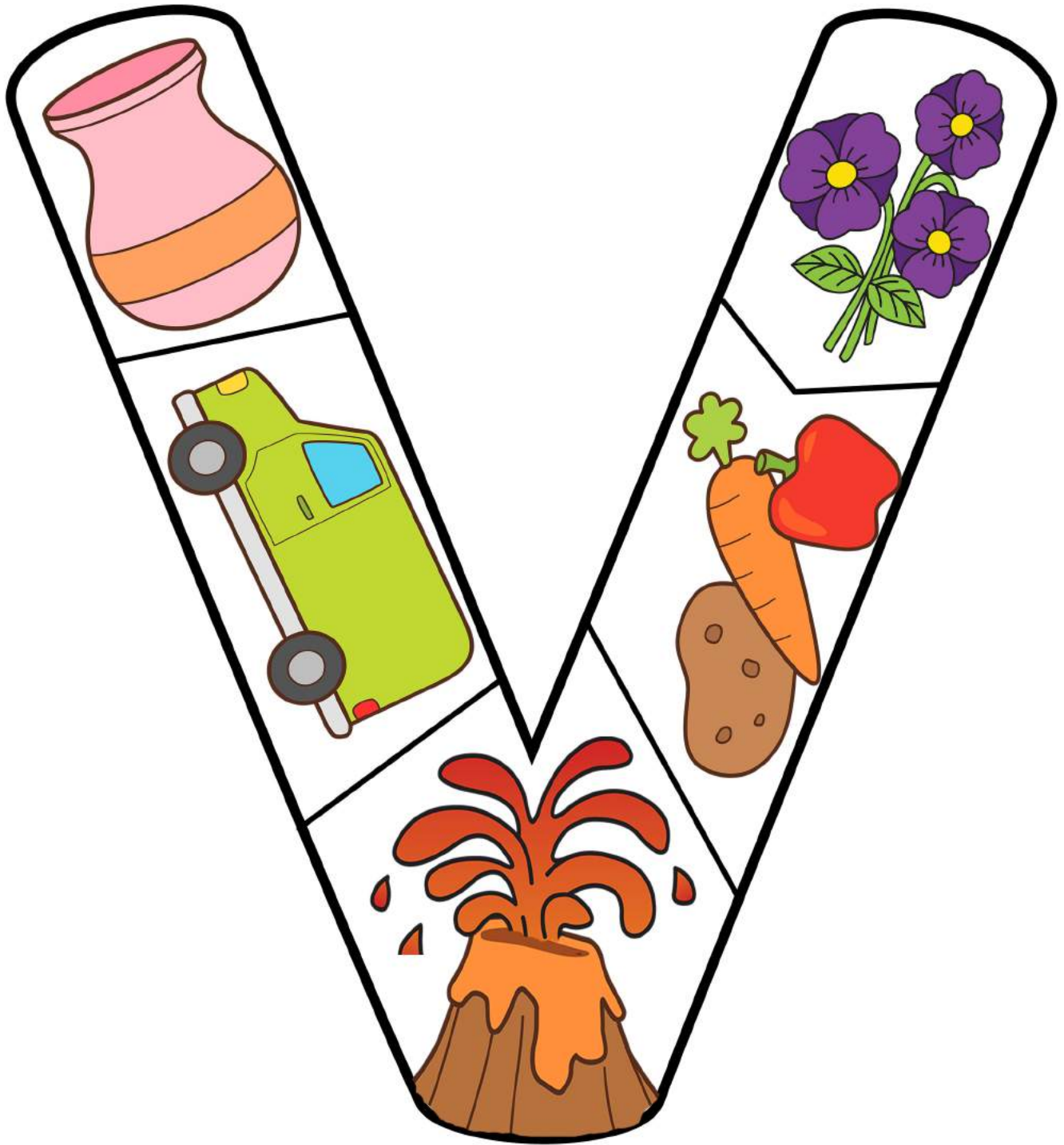

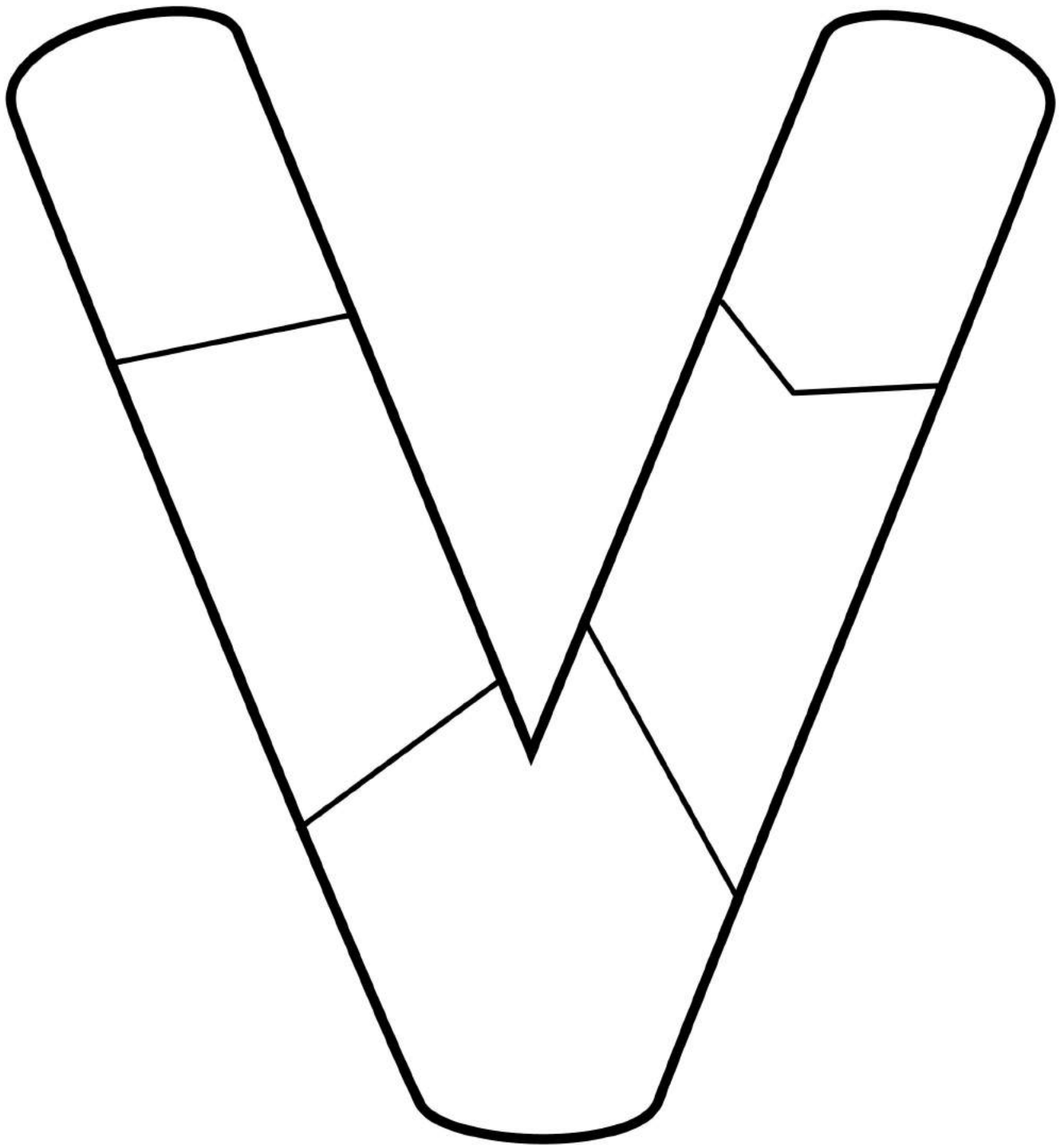

I C A N F I N D

the letter:

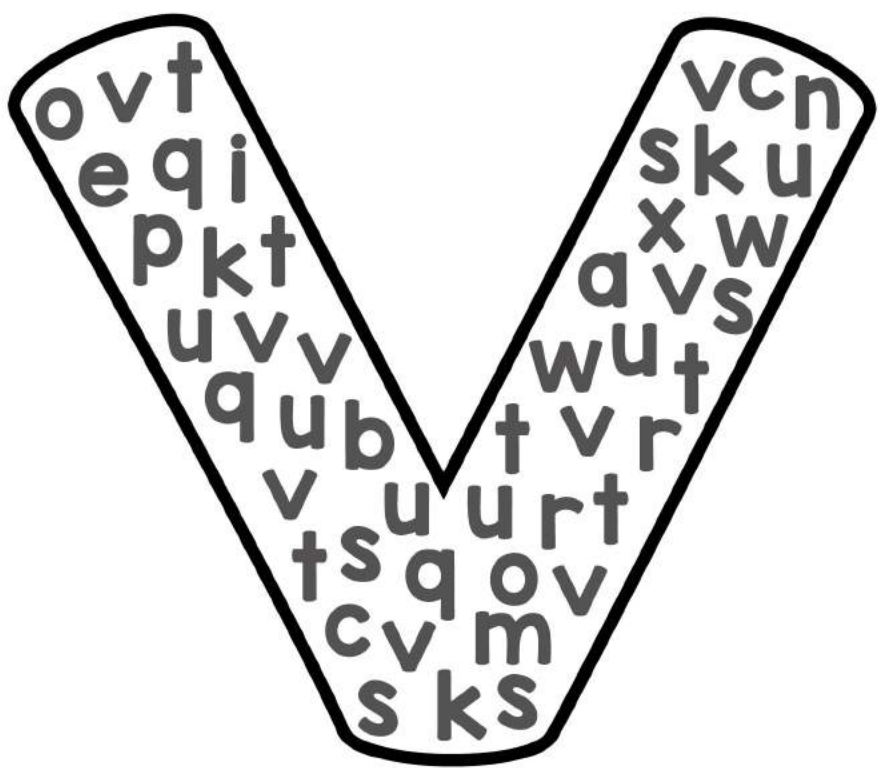
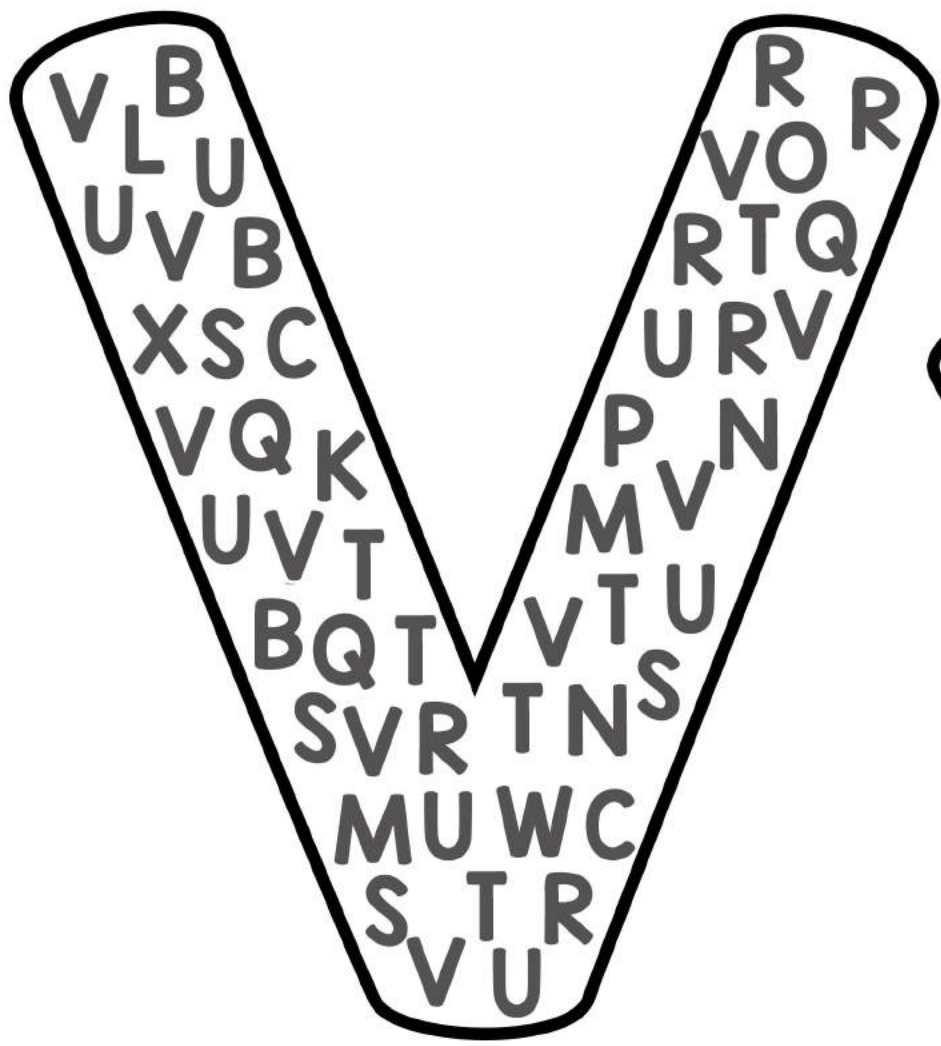

How Many?

How Many?

1. Write

2. Cut Out 

A B C Q U I L T

3. Color

4. Cut out 

NAME : _____

V V

V V

V V

V V

V V

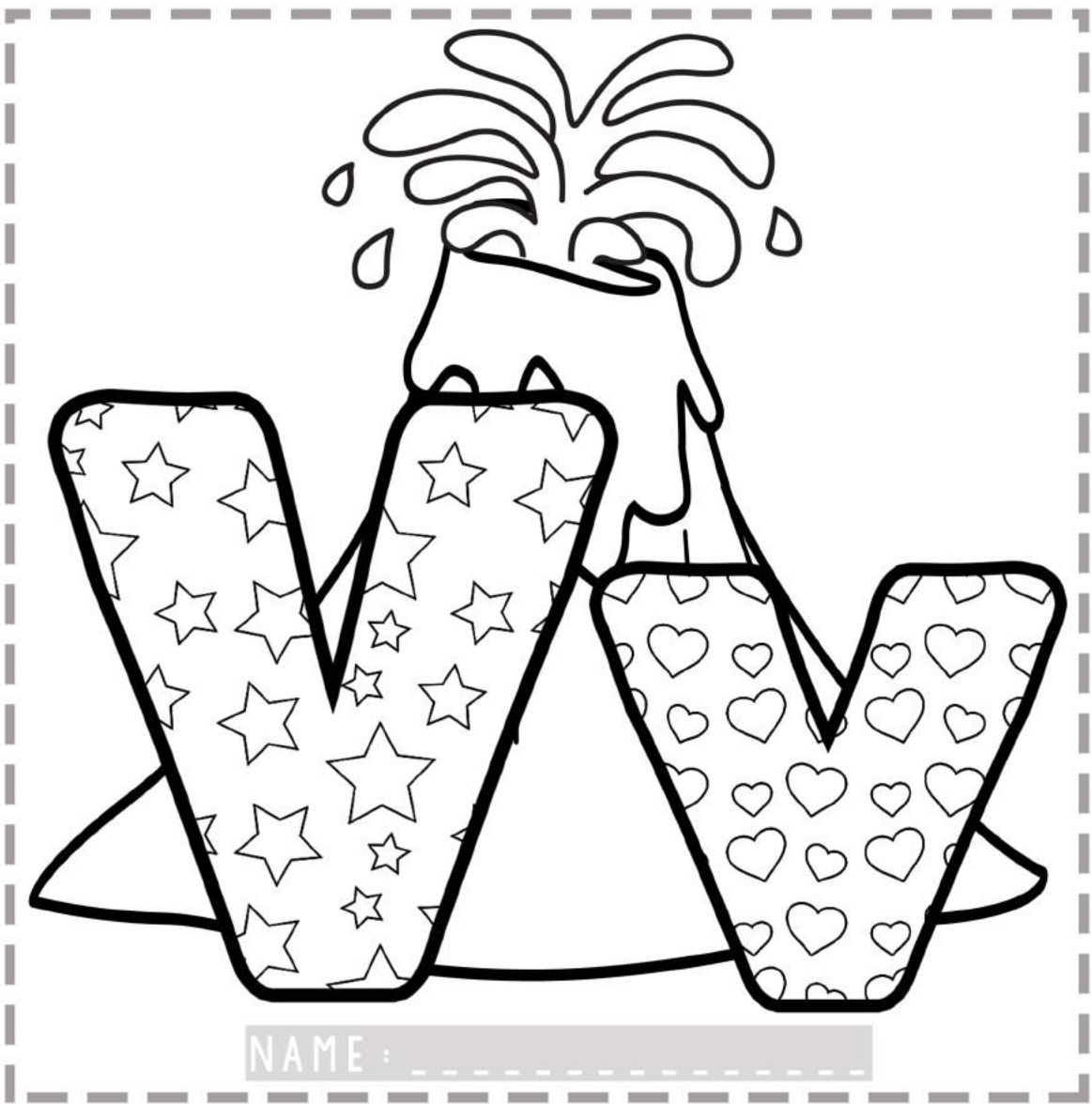

NAME : _____

Vv

Write and read words that begin with letter v.



van van van



vase vase



vest vest



violets violets



violin violin



vulture



volcano



vase



vest



vulture

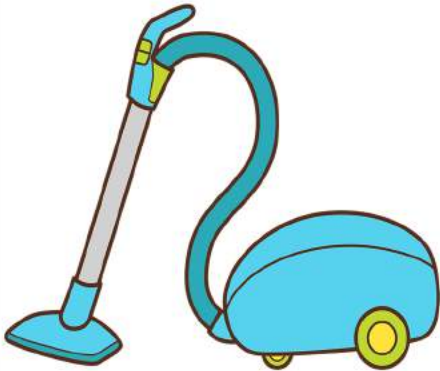

vacuum



vegetables



violets



volcano

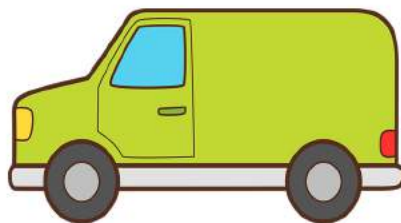

van



violin

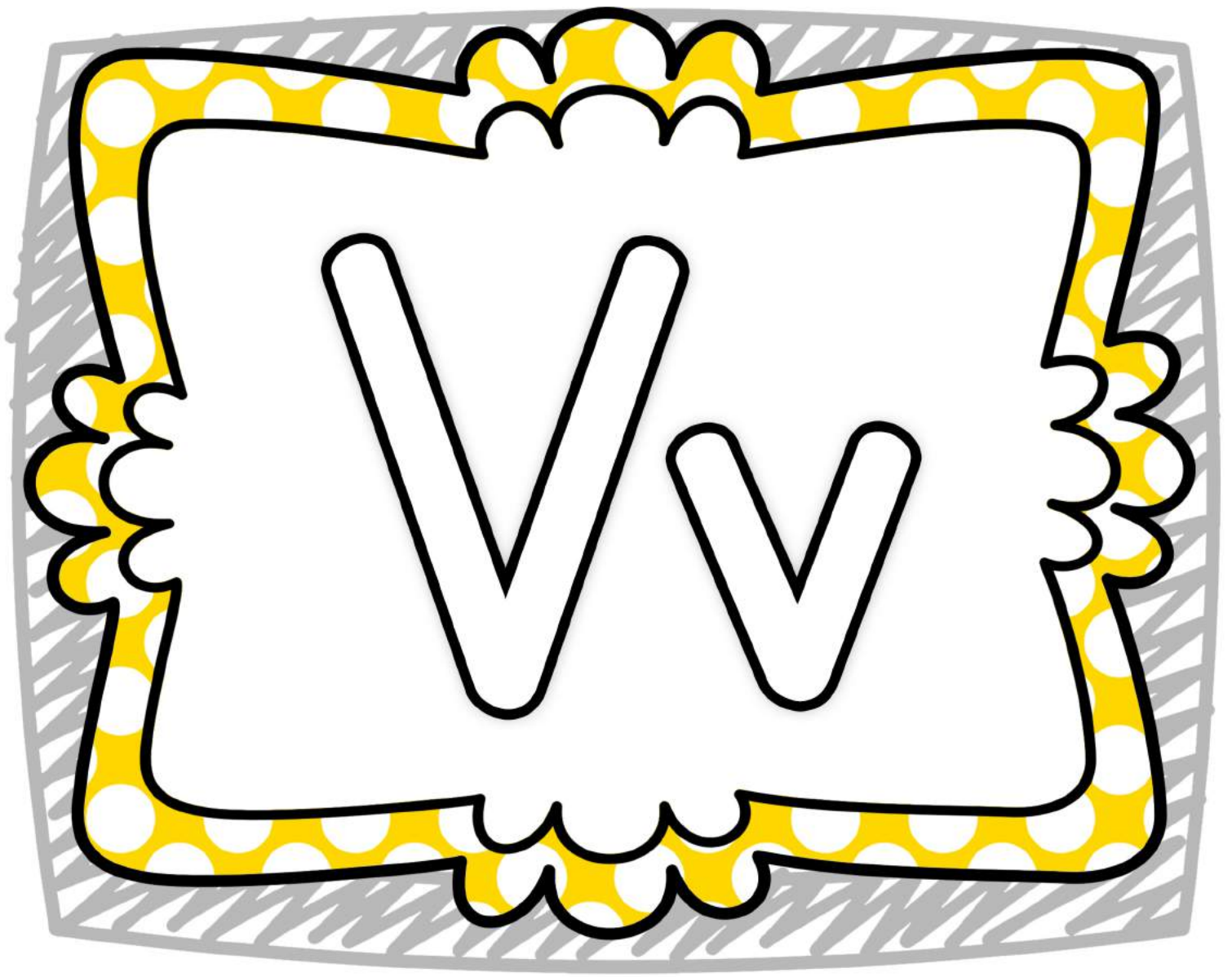

LETTER V



4 IN A ROW

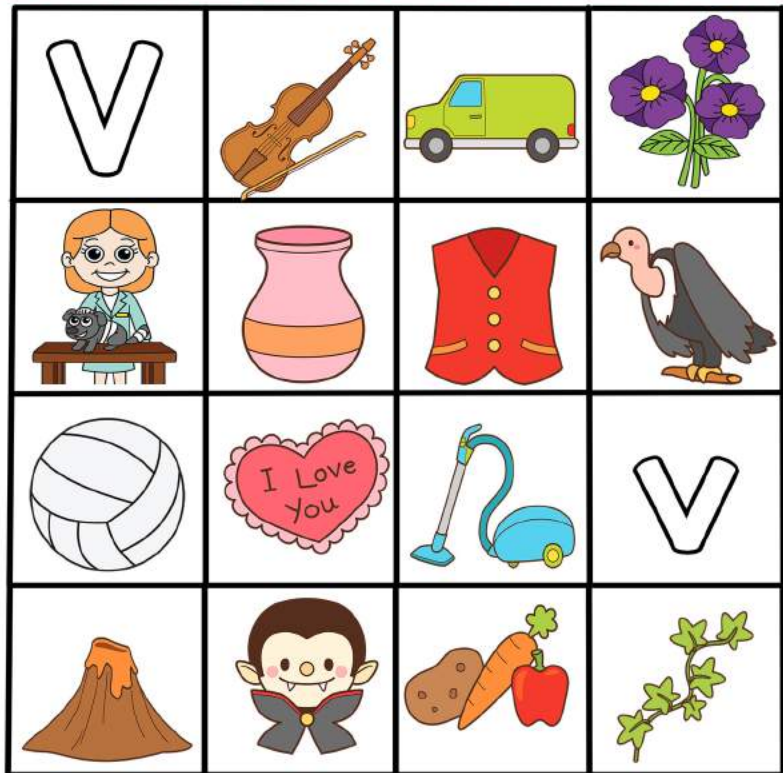

LETTER V





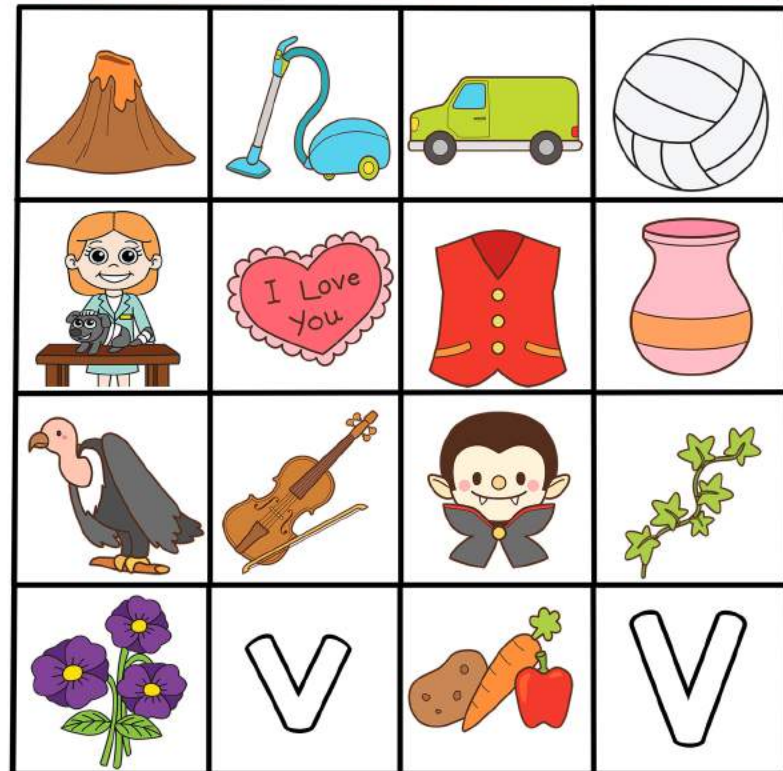













4 IN A ROW



LETTER V



















4 IN A ROW

LETTER V



4 IN A ROW

Images (c) Little Red's Clipart, Zip-a-De-Doo-Dah Designs & Miss Giraffe

I C A N W R I T E

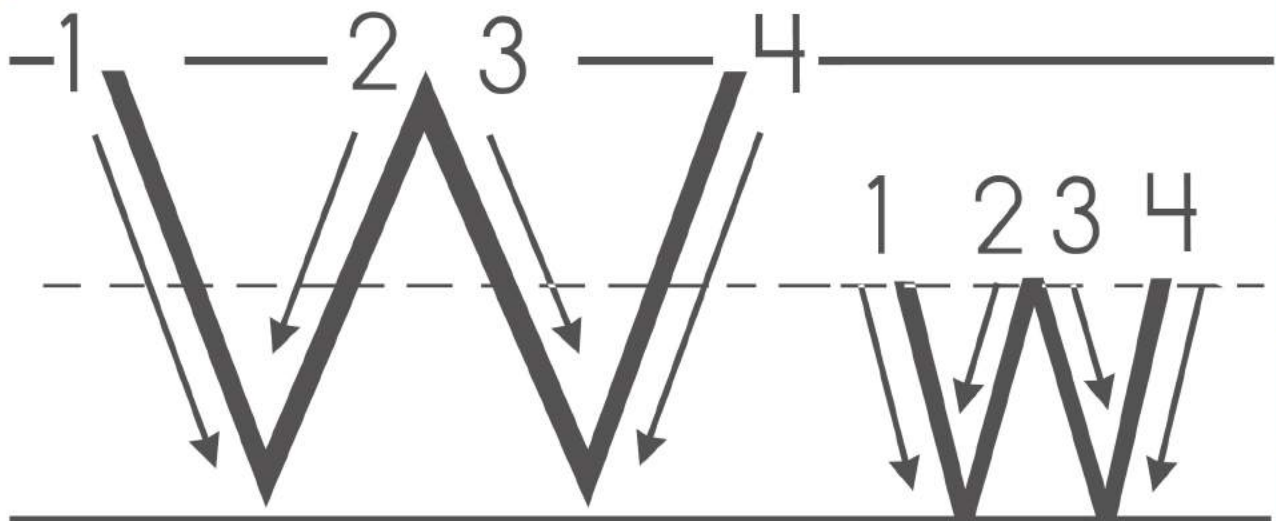

Slide Out

Pick up

Slide In

Pick up

Slide Out

Pick up

Slide In

Slide Out

Pick up

Slide In

Pick up

Slide Out

Pick up

Slide In

Whale

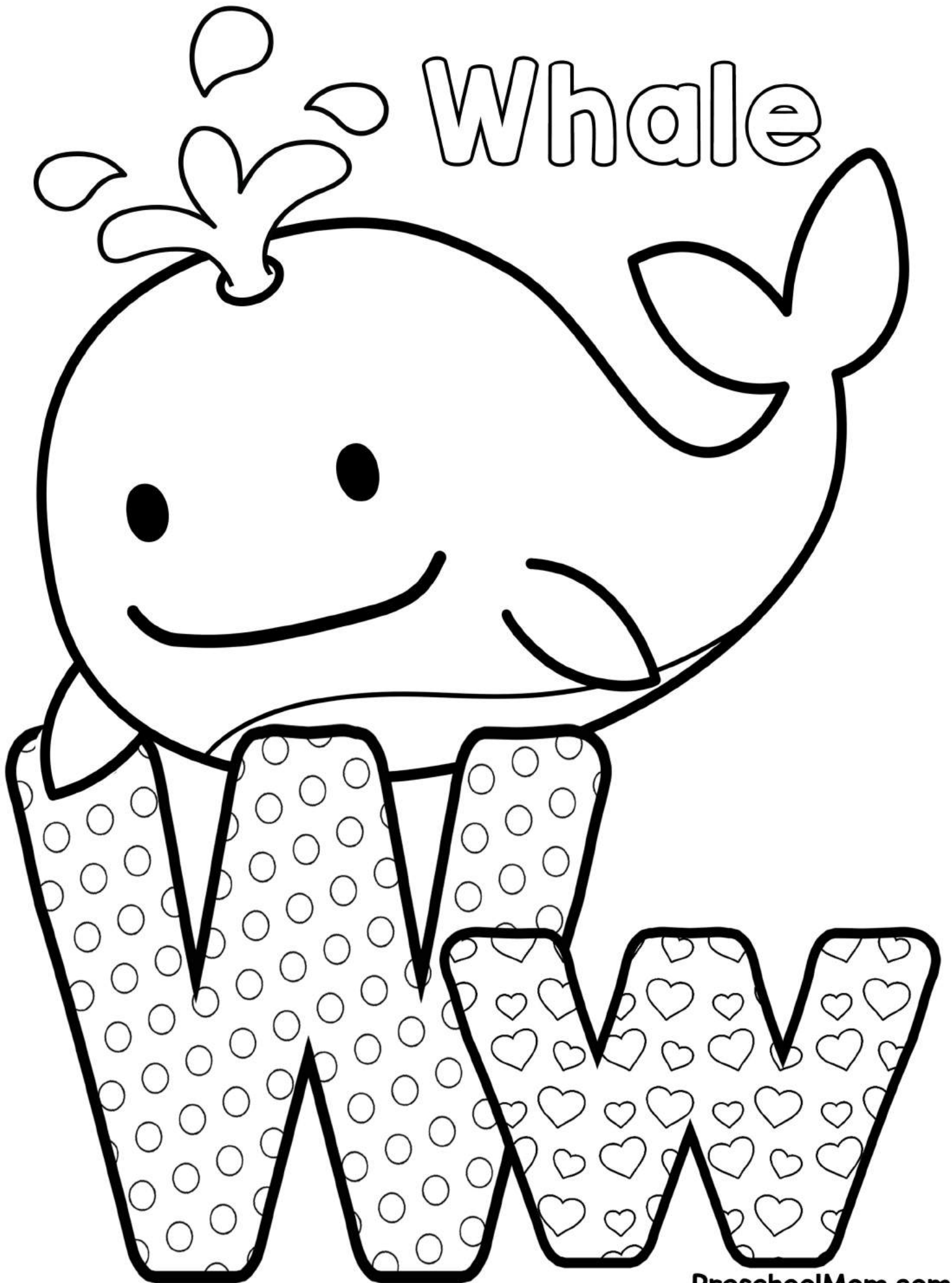

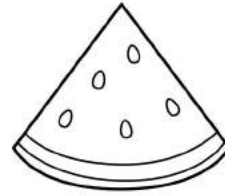
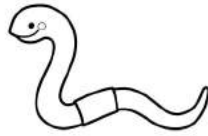
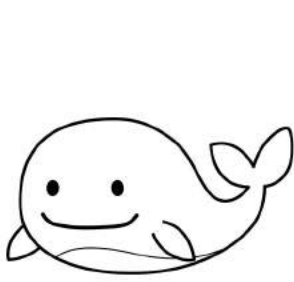
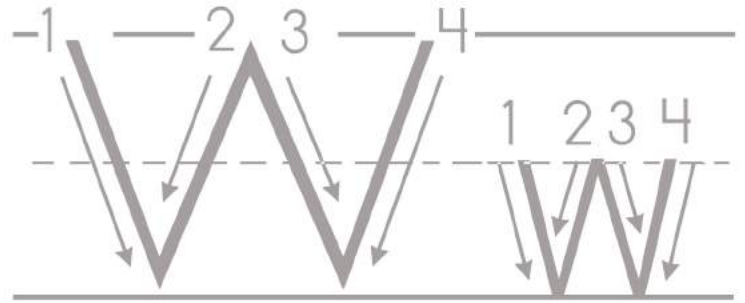

whale

wand

wheel

worm

watermelon

web

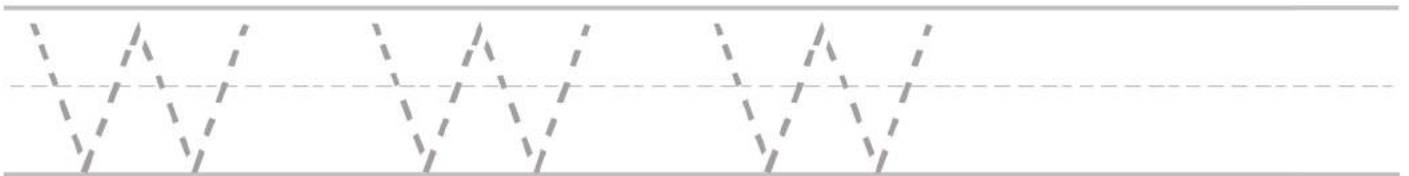
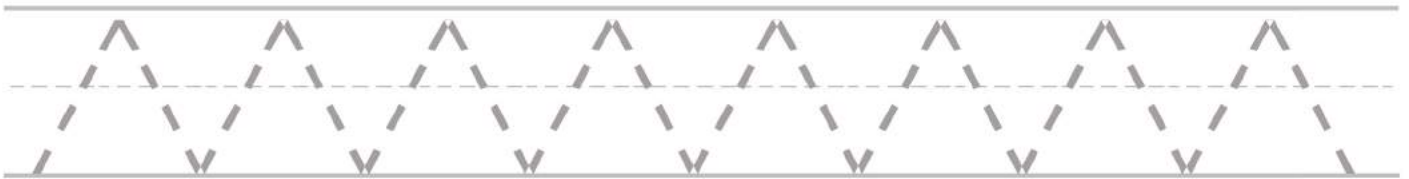

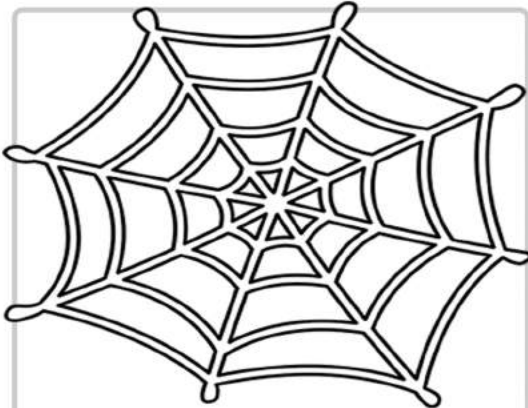

Draw eight spiders on the web

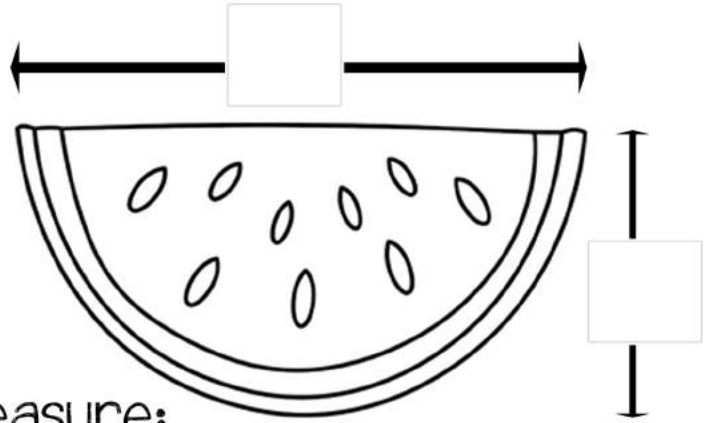

Measure:

12 watches minus 2 watches equals a box.

$$12 - 2 = \square$$

Count & Tally the watermelon seeds:

12 - 1 =

12 - 2 =

$$\begin{array}{r} 12 \\ - 3 \\ \hline \square \end{array}$$

$$\begin{array}{r} 12 \\ - 4 \\ \hline \square \end{array}$$

Circle groups of two wands. Count by 2's

Wanda found 8 wiggly worms. She used 4 on her fishing line. How many worms does Wanda have left?

Draw: $12 - 4 = 8$

$$\square - \square = \square$$

W

w

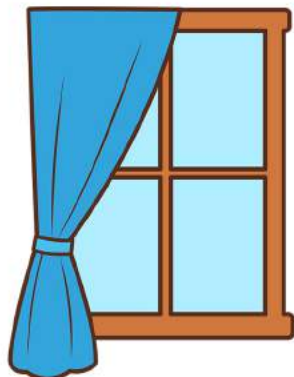
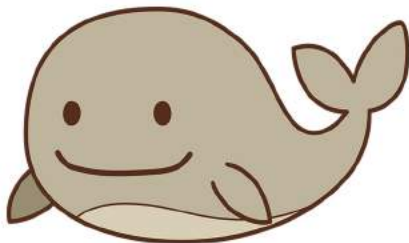
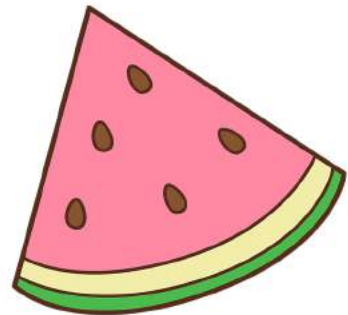
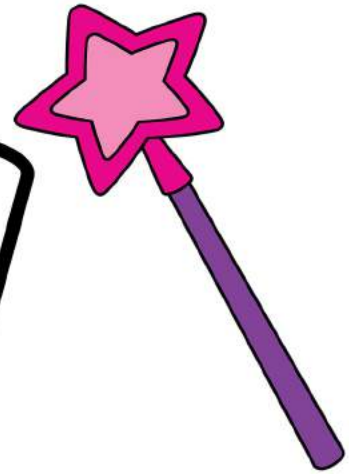

I CAN COLOR

words with:

-  = watermelon
-  = whale
-  = windmill
-  = worm
-  = wand
-  = web
-  = watch
-  = wheel

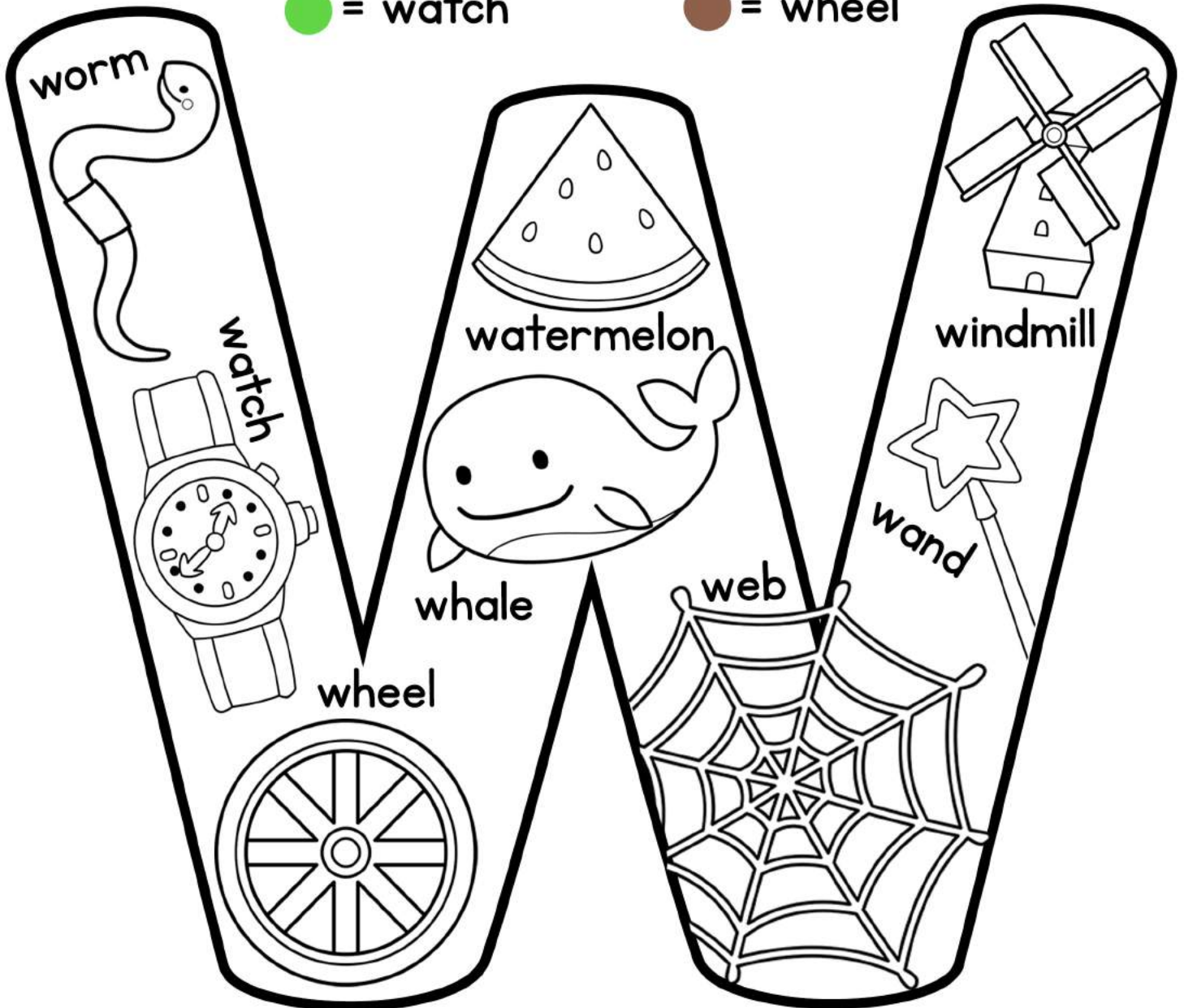

NAME : _____

Ww

Write and read words that begin with letter w.



web web web



wand wand



worm worm

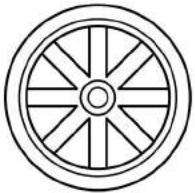

wheel wheel



watch watch



well well well

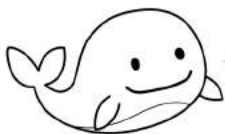

whale whale

NAME : _____

Ww

Write and read words that begin with letter w.



web web



wand wand



worm worm



wheel



watch



well well

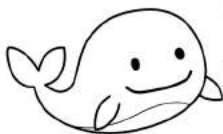

whale

NAME : _____

RACE TO THE TOP

Use a paperclip and a pencil to complete the spinner.

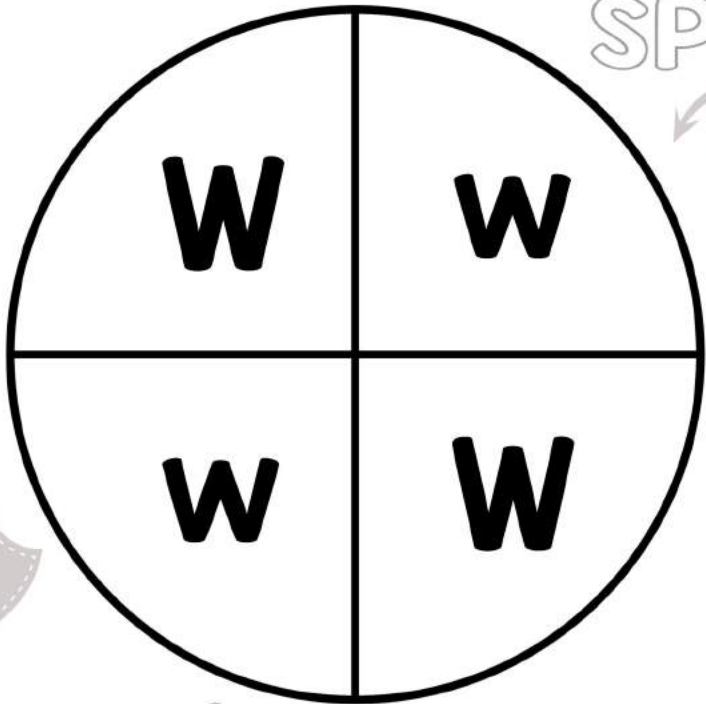

SPIN



Record

Report:

How many spins landed on W?

How many spins landed on w?

Which had more?

Write an inequality: >

How many spins total?







★ I ★

★ C ★ ★ A ★ ★ N ★

★ F ★ ★ I ★ ★ N ★ ★ D ★

the letter:

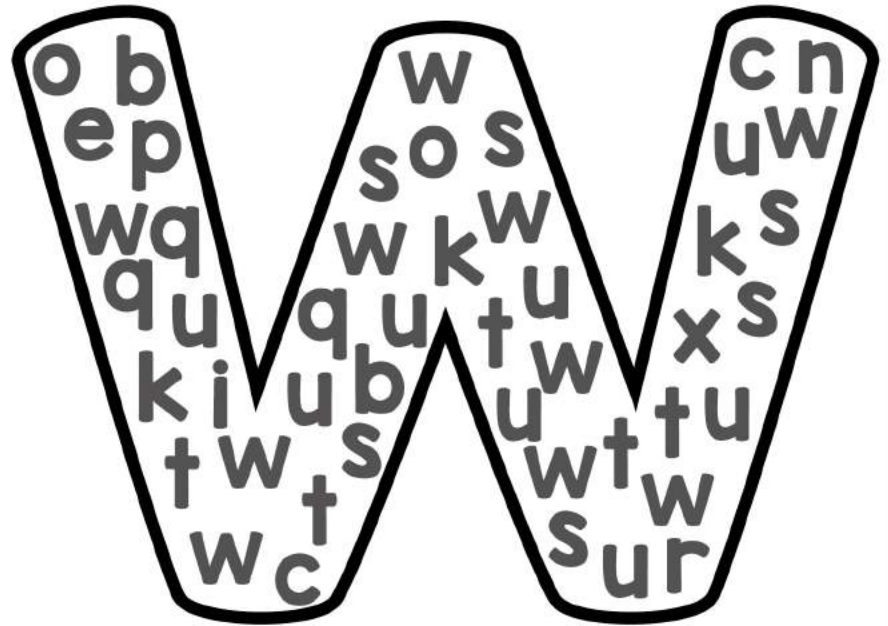
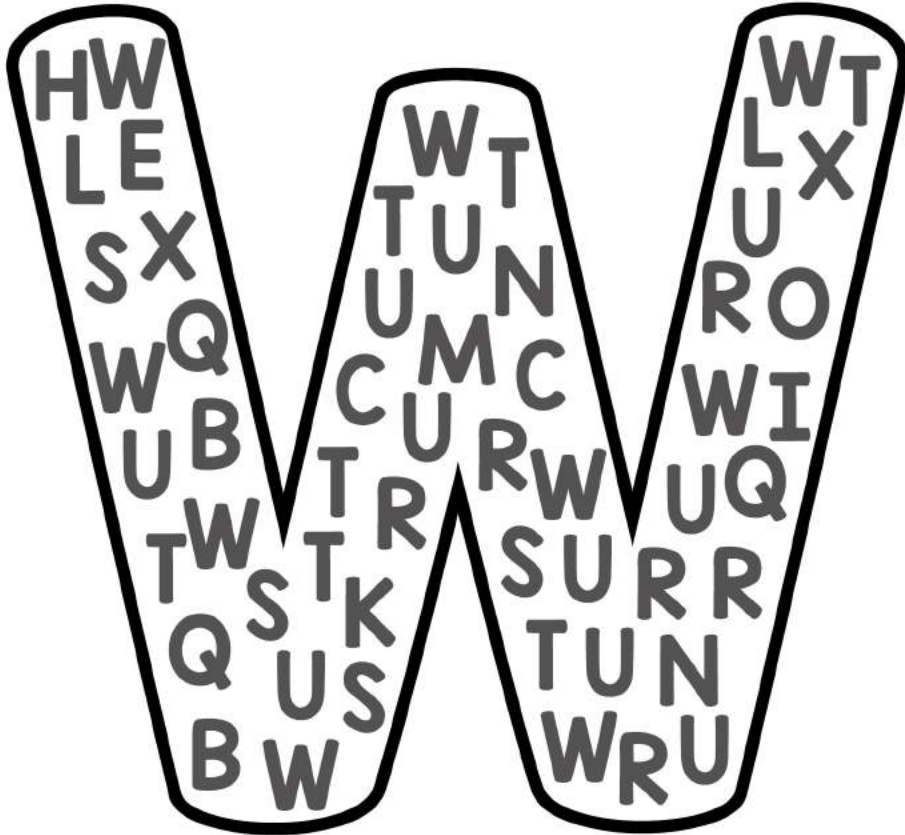

How Many?

How Many?

TRACE

NAME : _____

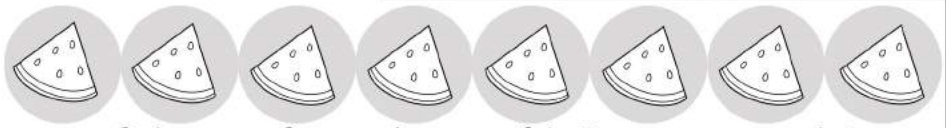

Color one for each row of letters you complete







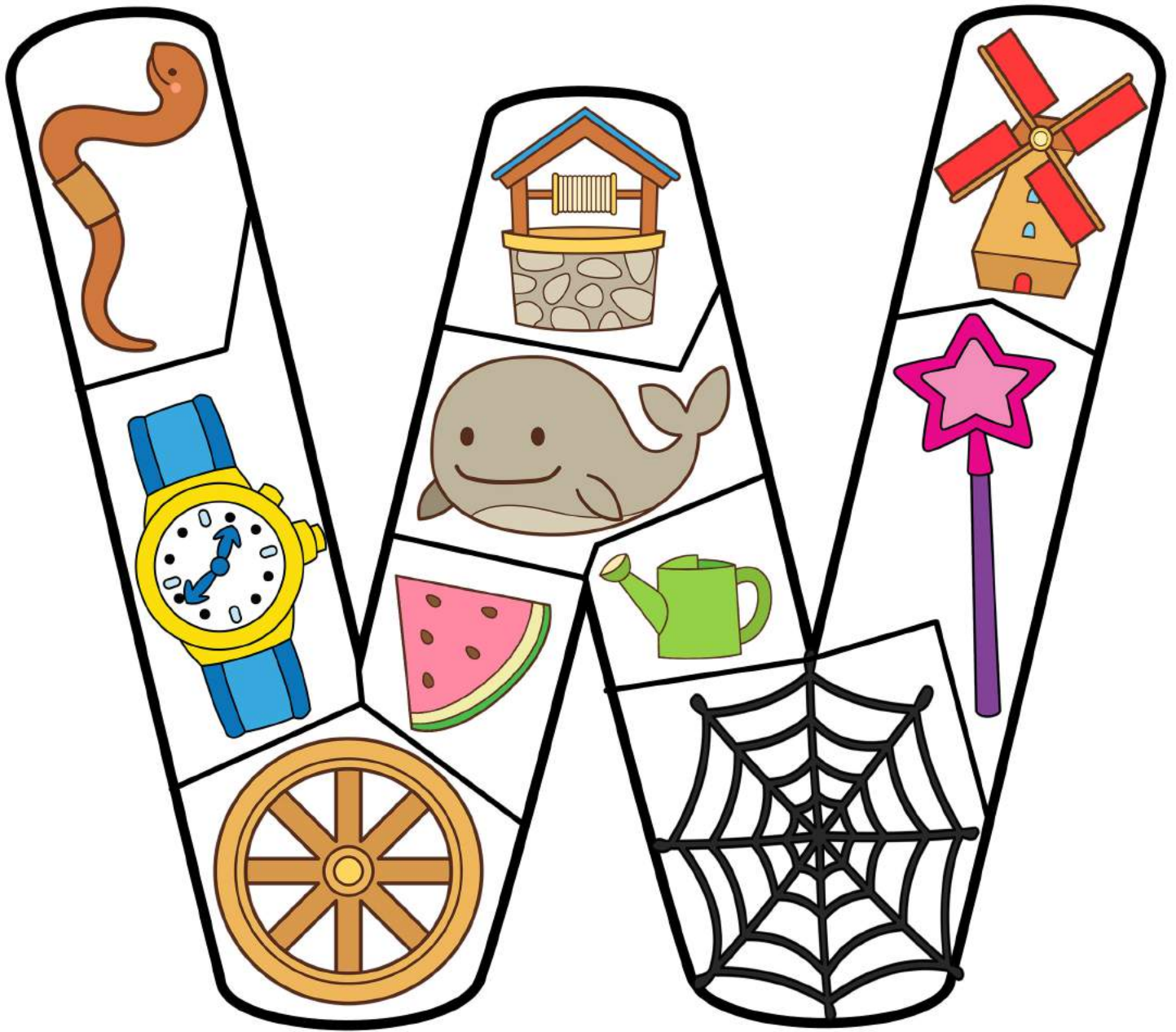

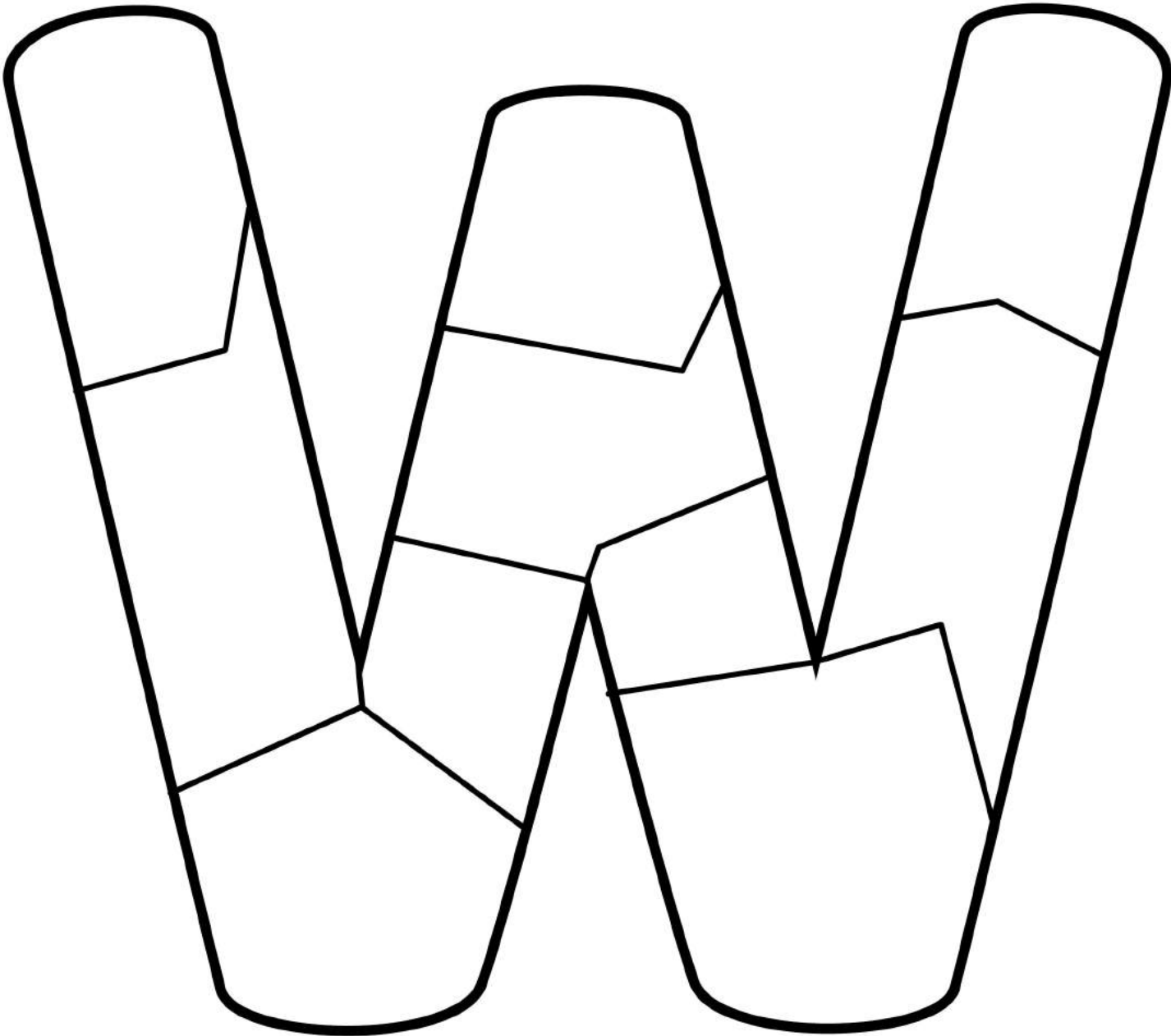

1. Write

2. Cut Out 

NAME : _____

W W

W W

W W

W W

W W

A B C Q U I L T

3. Color

4. Cut out 

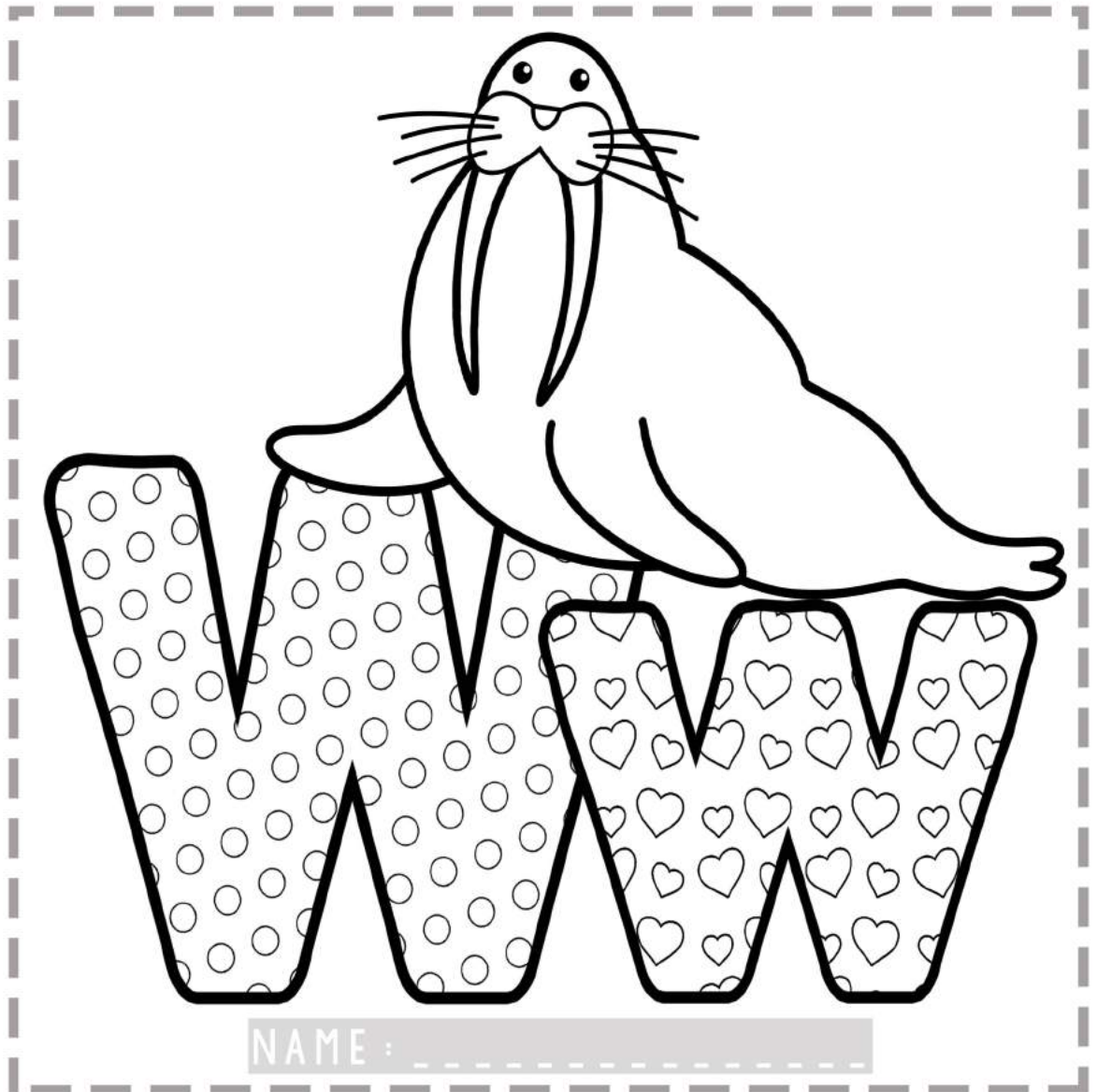

NAME : _____

Ww

Write and read words that begin with letter w.



web web web



wand wand



worm worm



wheel wheel



watch watch



well well well



whale whale

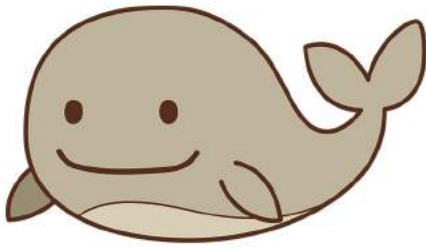

whale



web



well



wand



watch

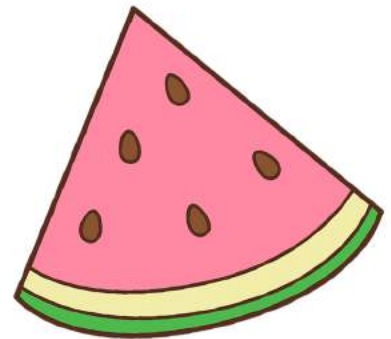

watermelon



wheel

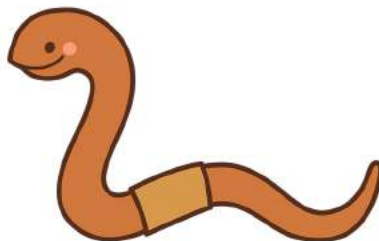

worm



windmill

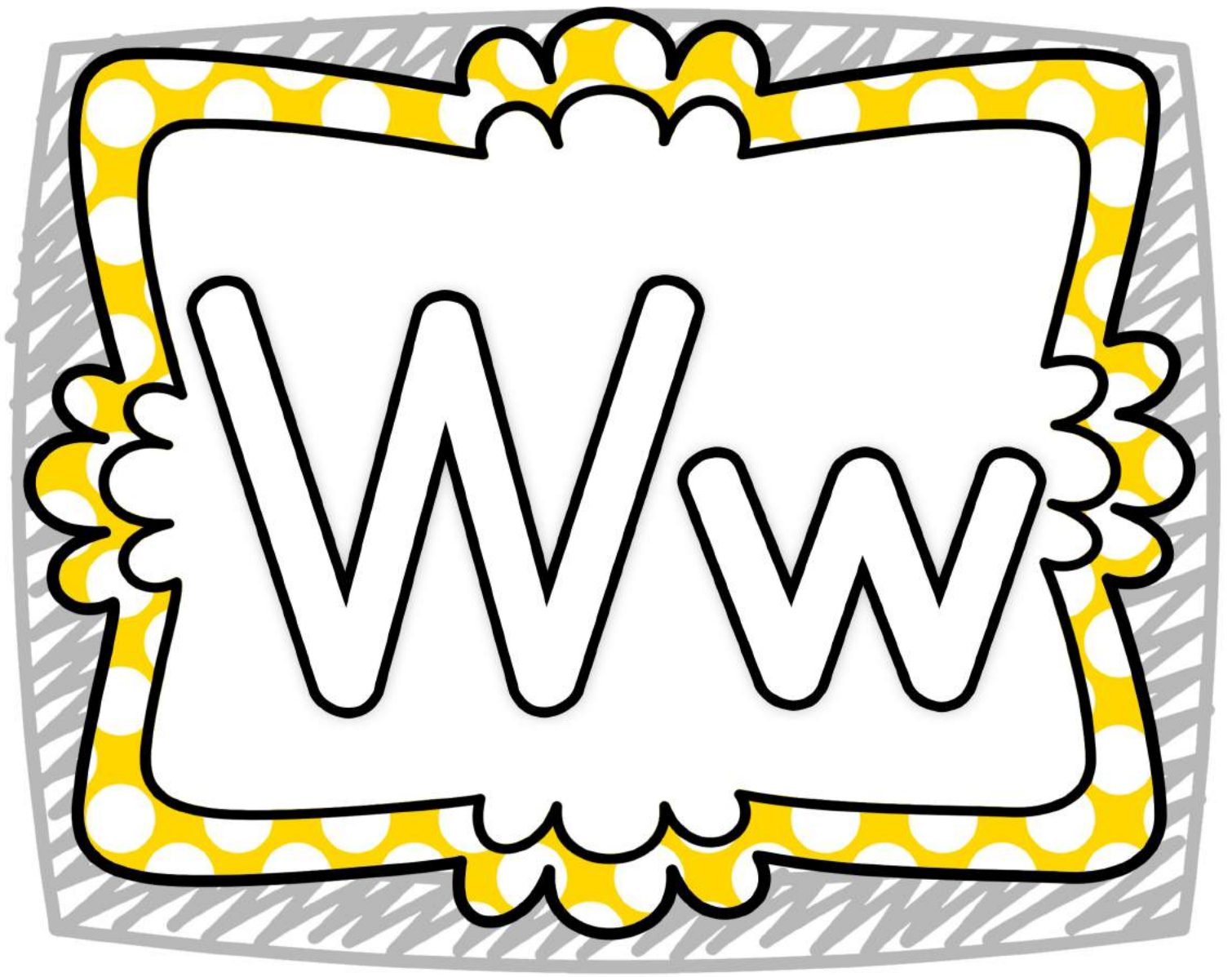

LETTER W



4 IN A ROW

LETTER W



4 IN A ROW

LETTER W



4 IN A ROW

LETTER W



4 IN A ROW

I C A N W R I T E

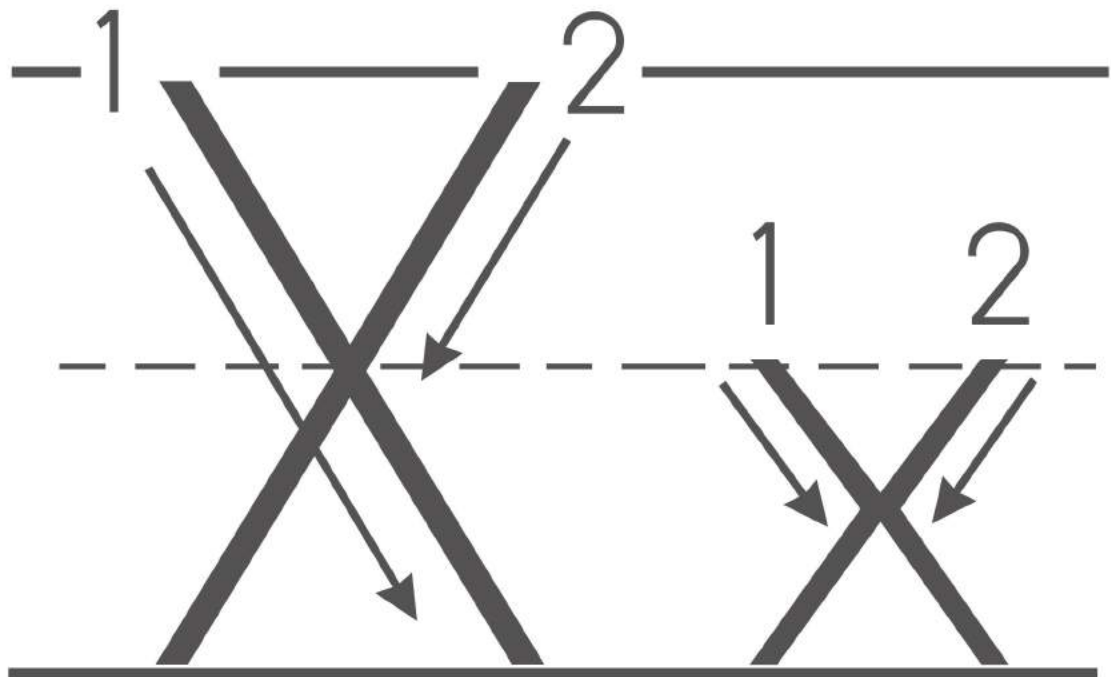

Slide Down
Pick up
Cross Back

Slide Down
Pick up
Cross Back

x-ray

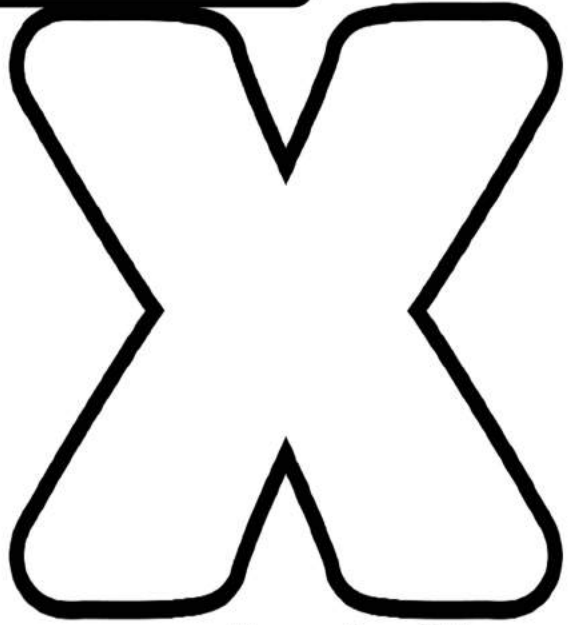
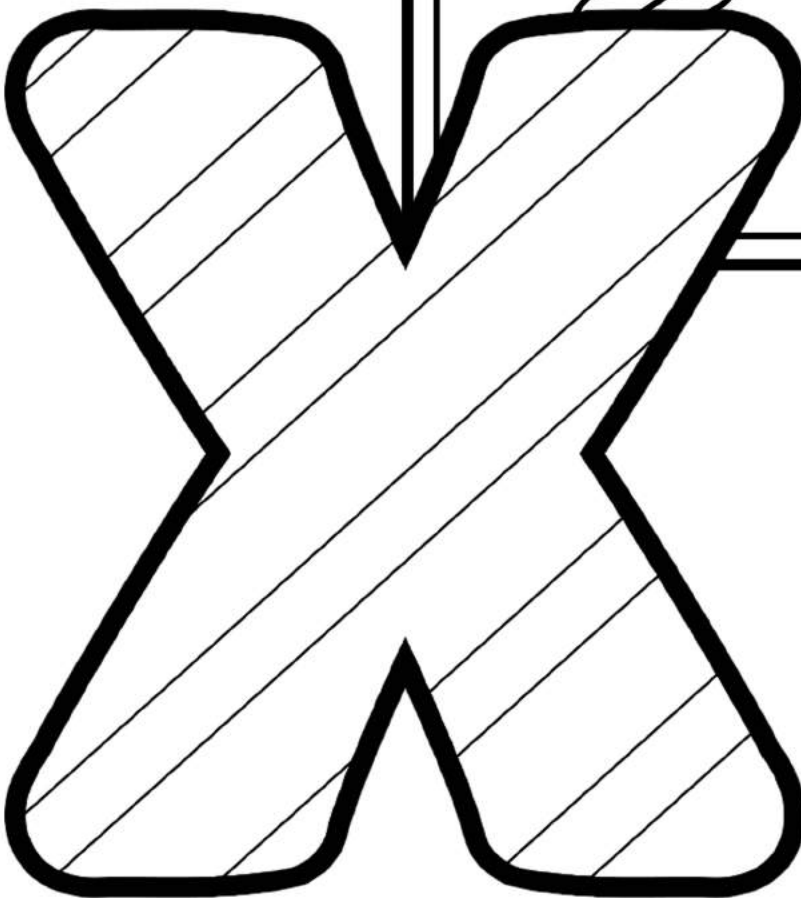
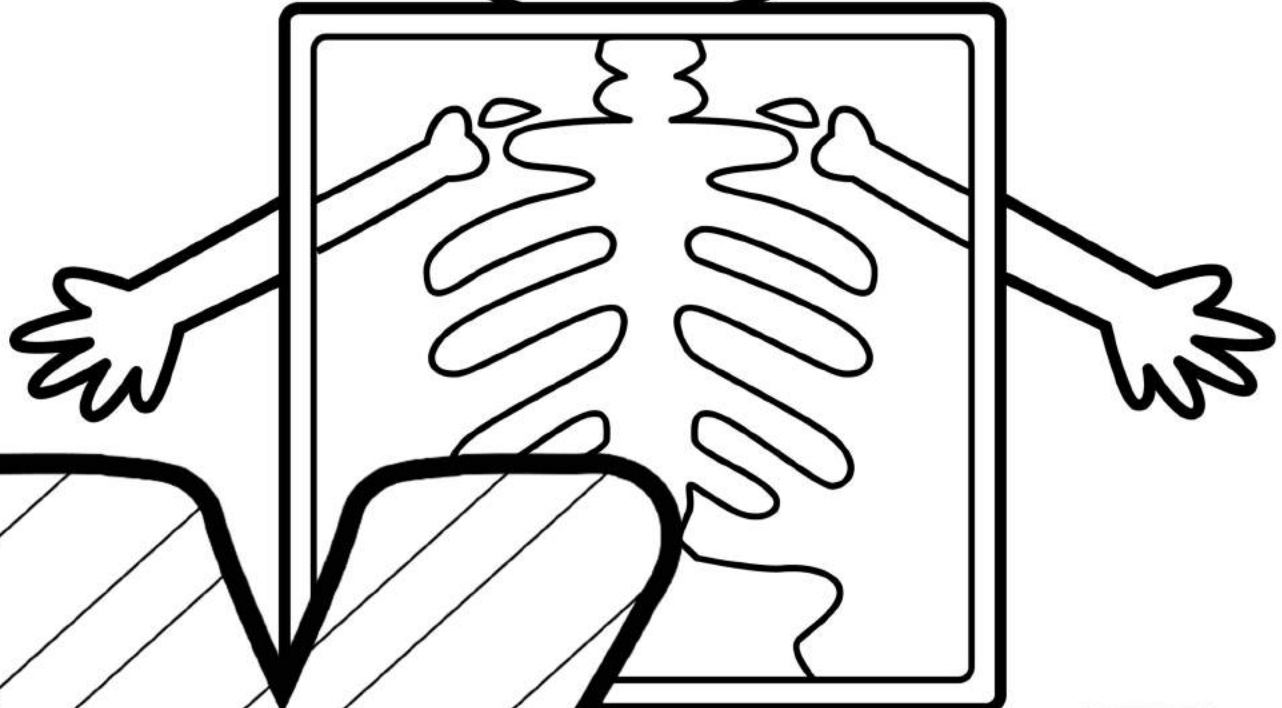

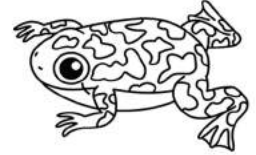
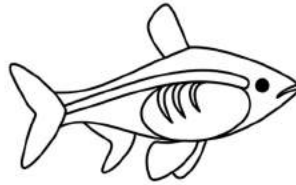
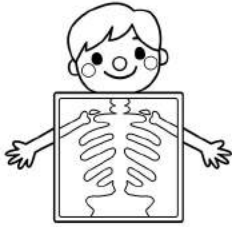
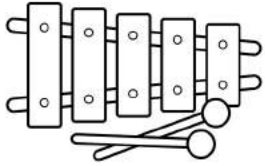
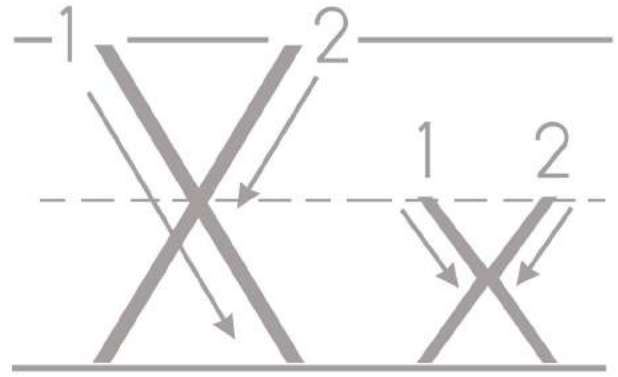
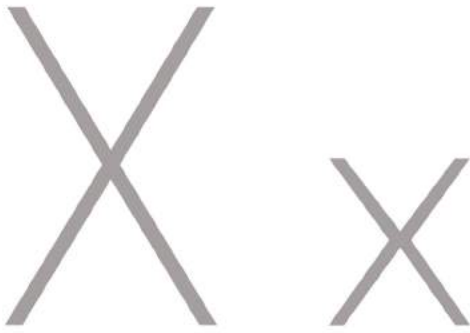

xylophone

x-ray

x-ray fish

xenops

xenopus



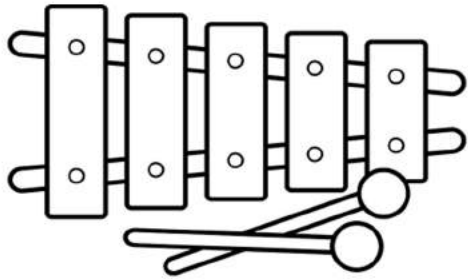

Color each bar a different color

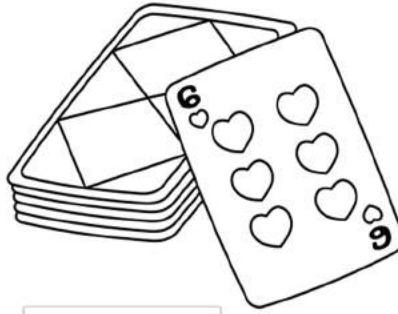

$2 + 4$

$5 + 1$

$3 + 5$

$1 + 5$

$4 + 2$

$4 + 3$

$3 + 3$

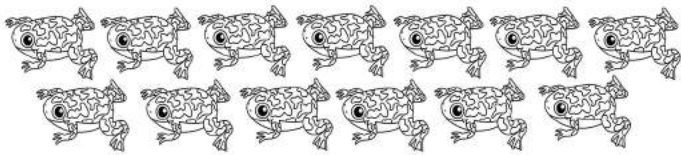

-

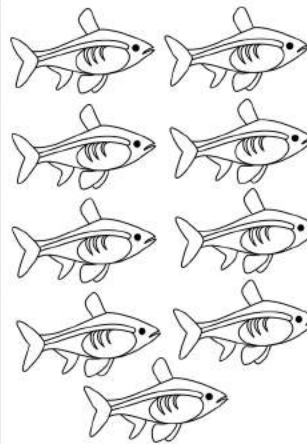
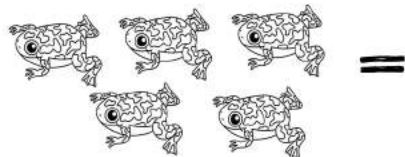

Count & Tally the x-ray fish

$13 - 1 = \square$

$13 - 2 = \square$

$$\begin{array}{r} 13 \\ - 1 \\ \hline \square \end{array}$$

$$\begin{array}{r} 13 \\ - 2 \\ \hline \square \end{array}$$

Circle groups of two. Count by 2's

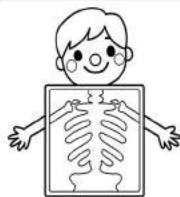
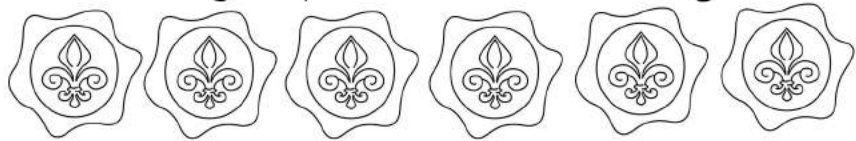

Xavier examined 5 patients on Tuesday and 3 patients on Wednesday. How many patients did he examine in all?

Draw: $13 - 2 = 11$
 $13 + 3 =$

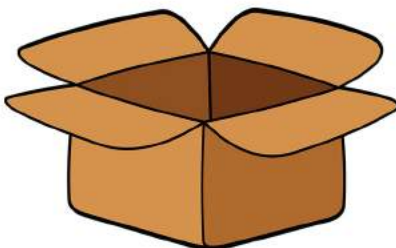
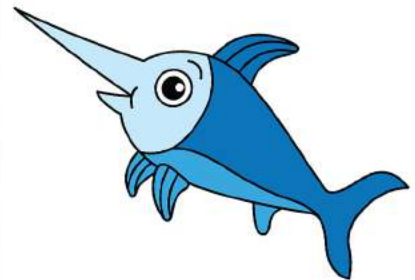
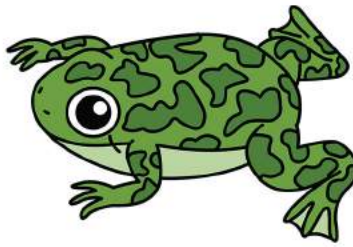
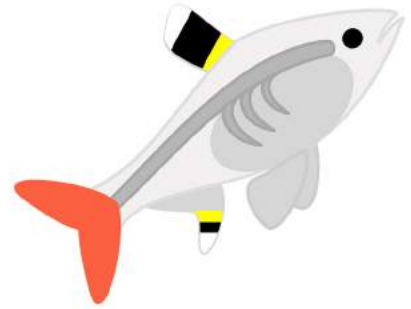
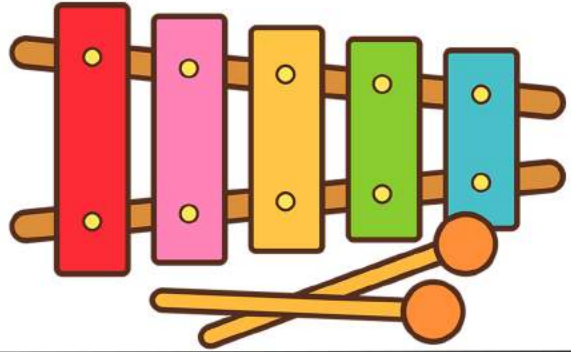
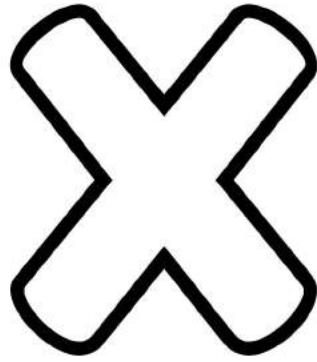
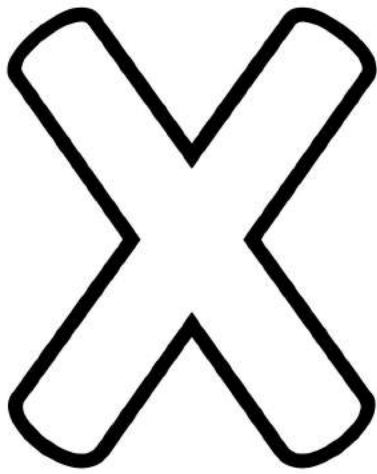

I C A N C O L O R

words with:

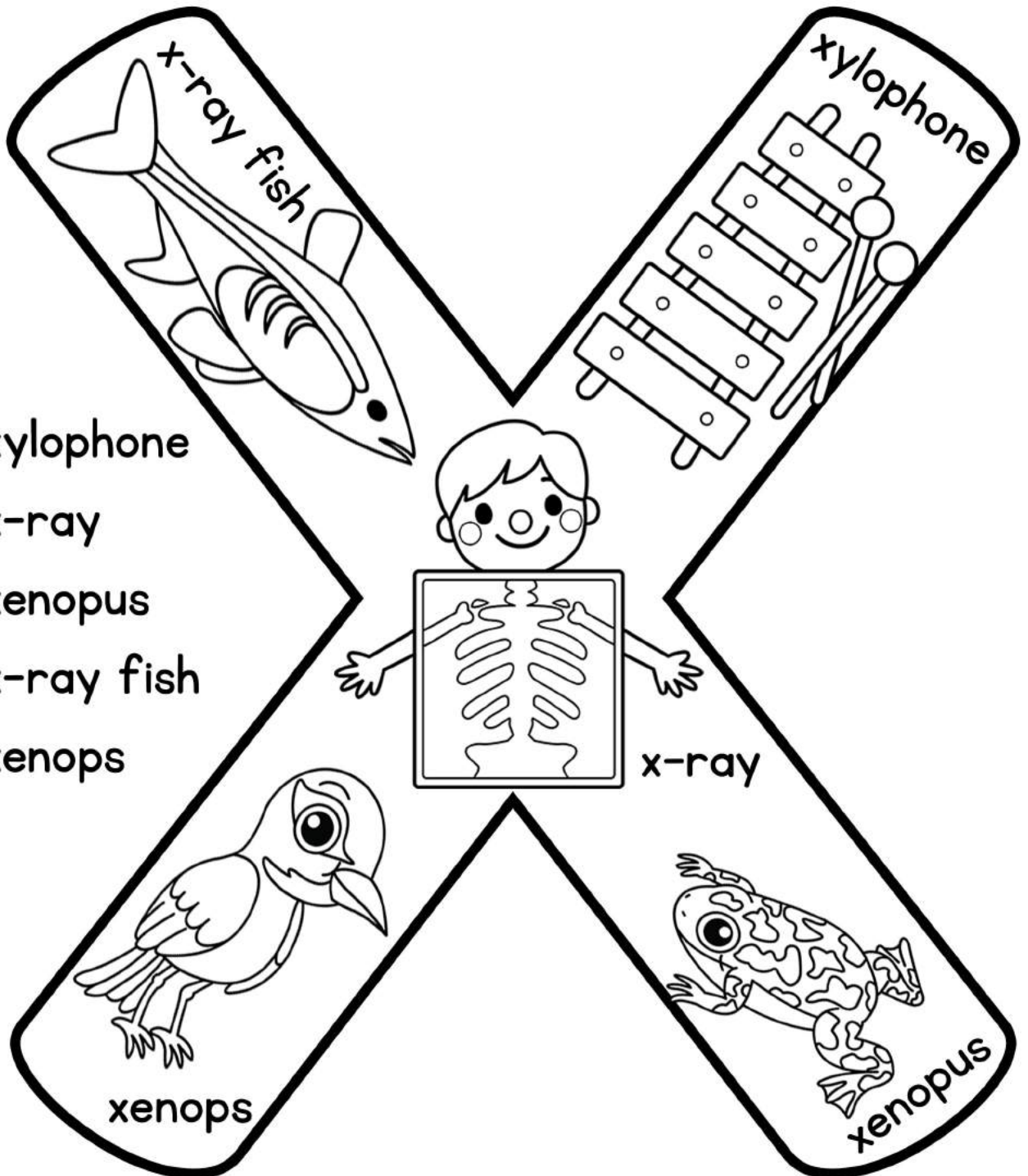

- = xylophone
- = x-ray
- = xenopus
- = x-ray fish
- = xenops

NAME : _____

Xx

Write and read words that begin with letter x.

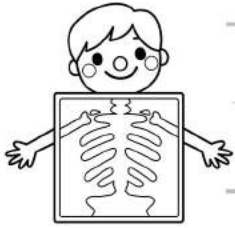

x-ray x-ray

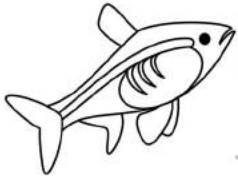

x-ray fish

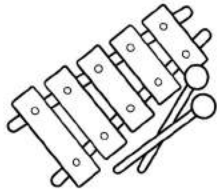

xylophone

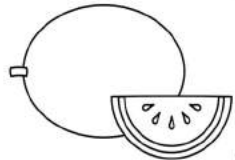

xigua xigua



xenops

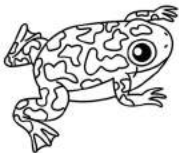

xenopus

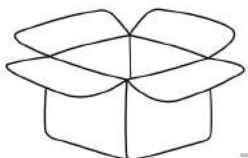

box box box

NAME : _____

Xx

Write and read words that begin with letter x.

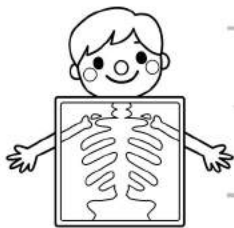

x-ray x-ray

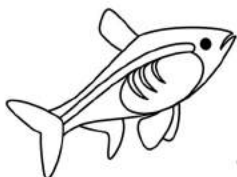

x-ray fish

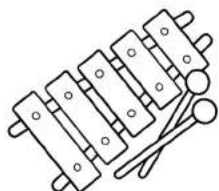

xylophone

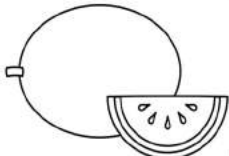

xigua xigua



xenops

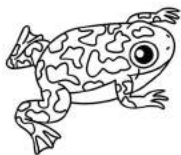

xenopus

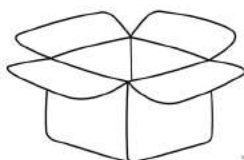

BOX BOX

NAME : _____

RACE TO THE TOP

Use a paperclip and a pencil to complete the spinner.

X	X
X	X
X	X
X	X
X	X
X	X
X	X
X	X
X	X
X	X

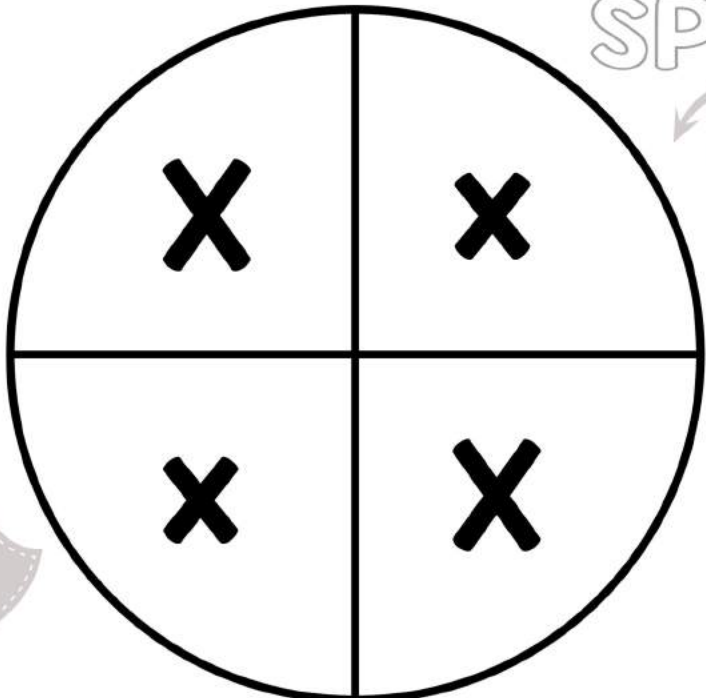

SPIN

Record

Report:

How many spins landed on X?

How many spins landed on x?

Which had more?

Write an inequality: >

How many spins total?

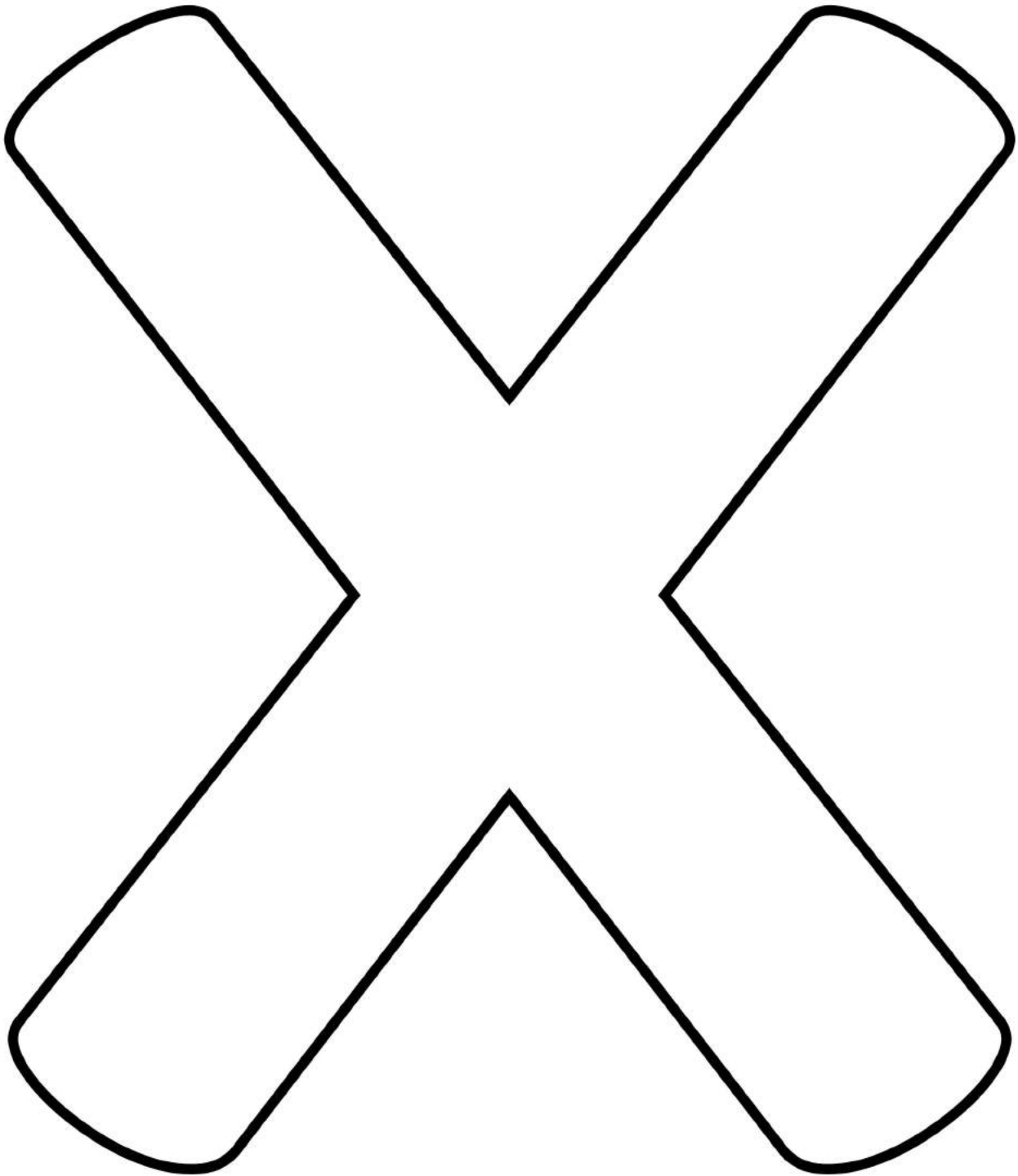

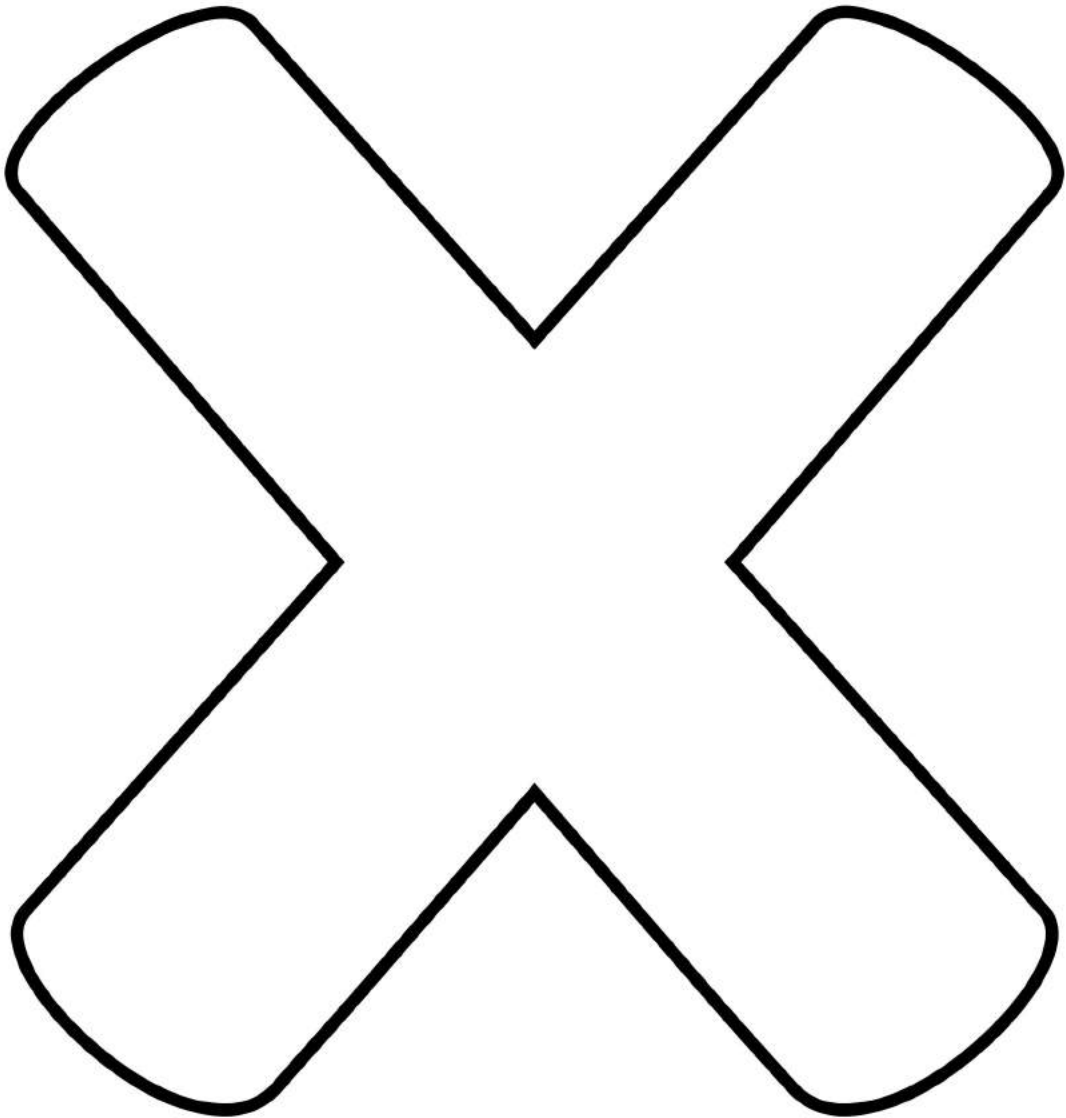

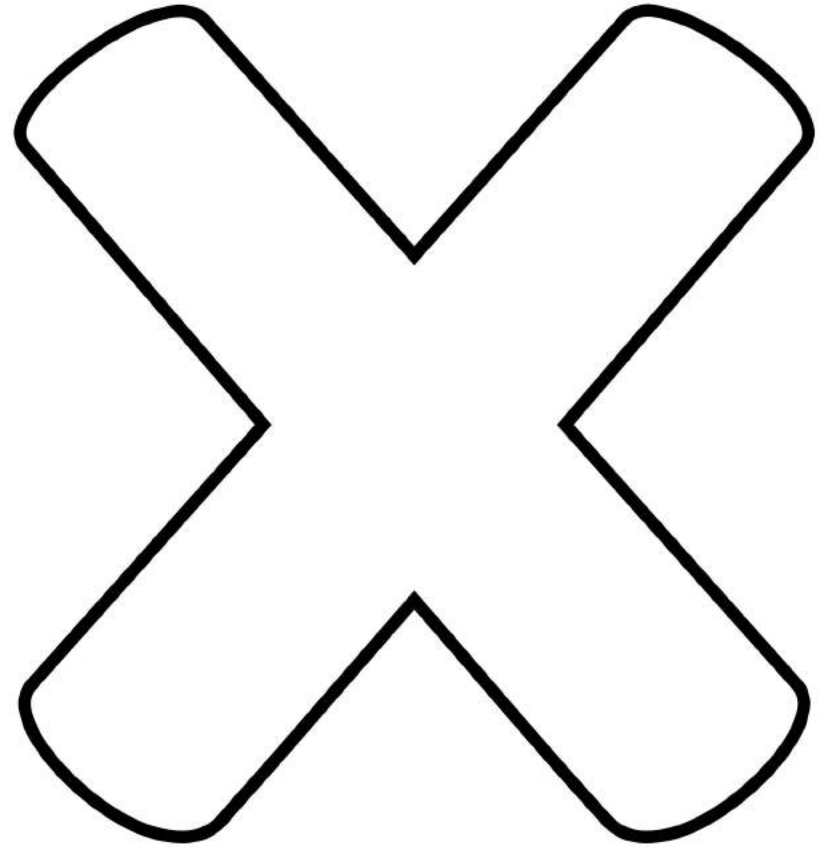
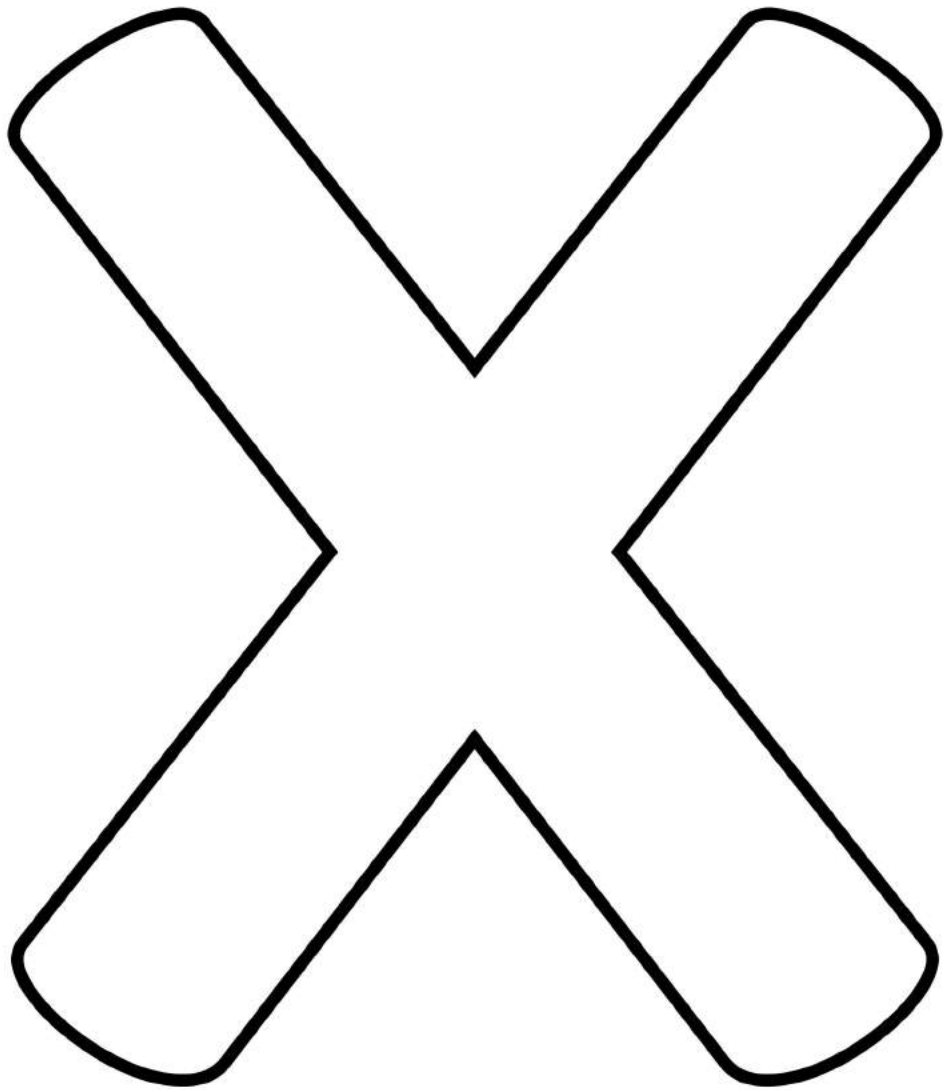

I

C A N

F I N D

the letter:

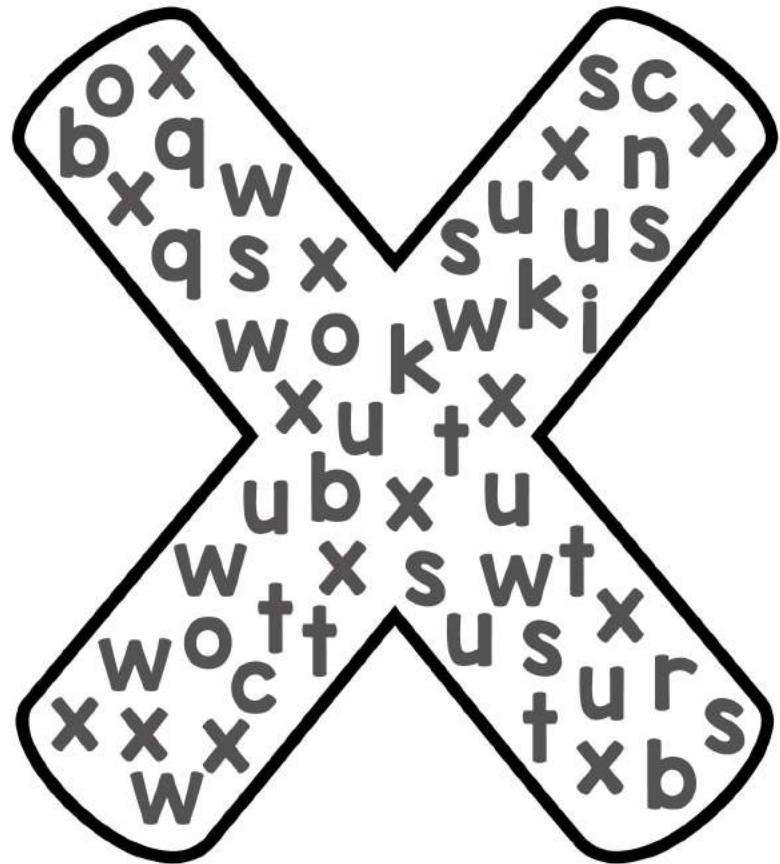
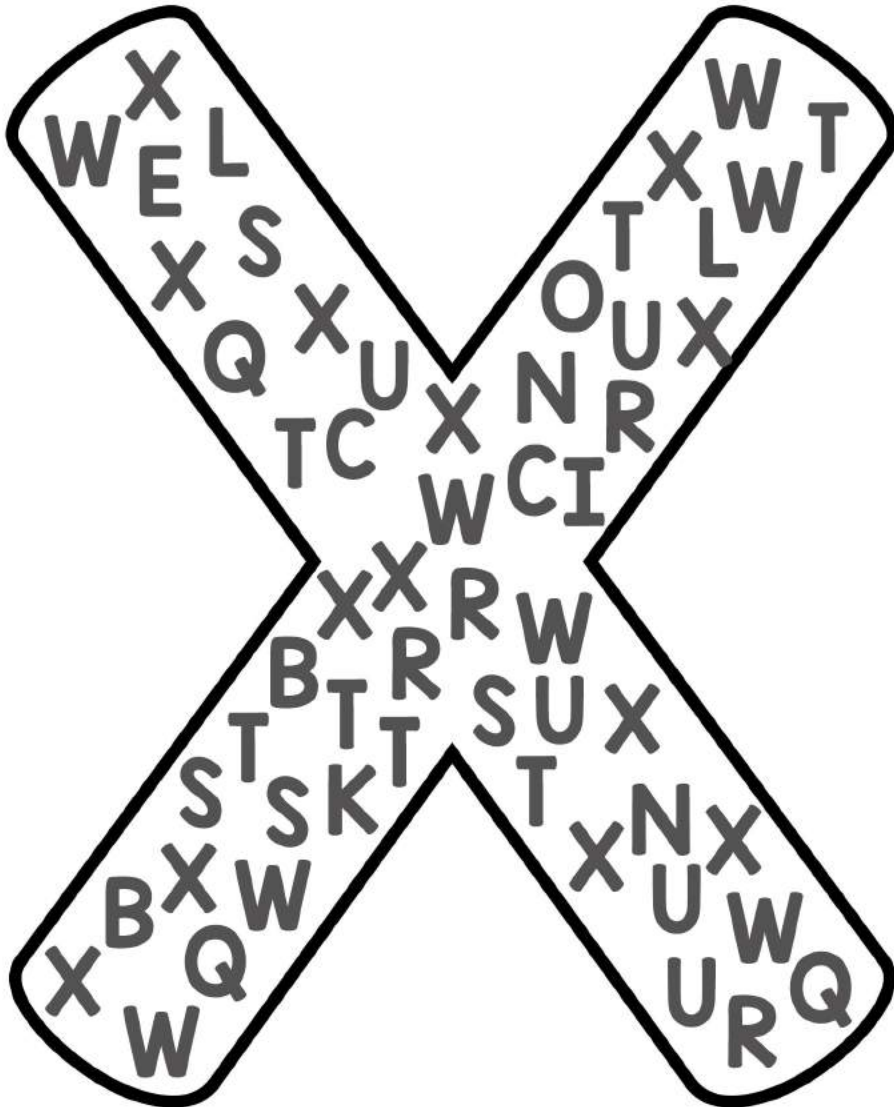

How Many?

How Many?

TRACE

NAME : _____



Color one for each row of letters you complete

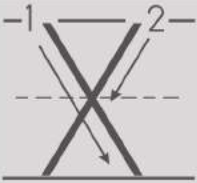

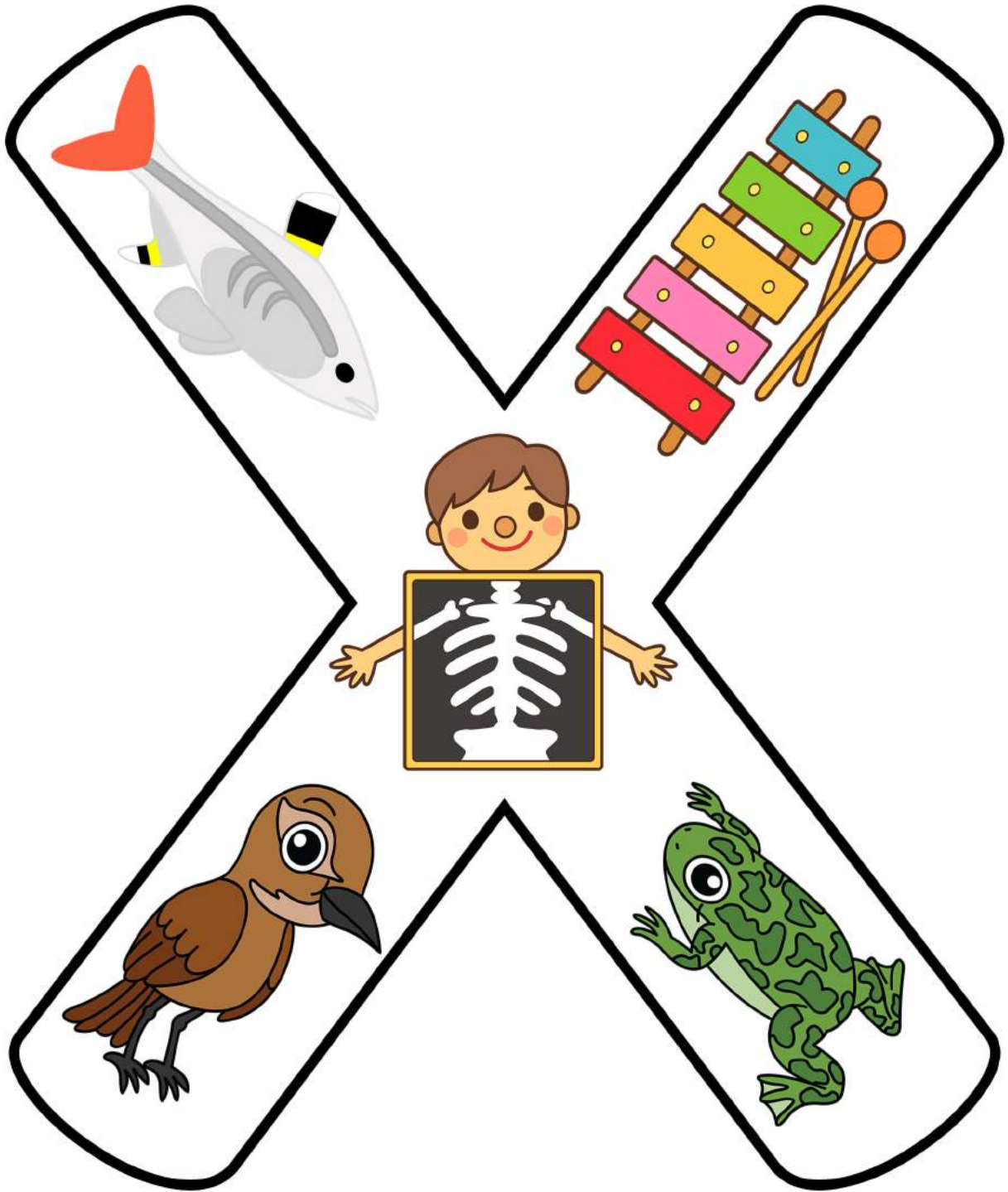

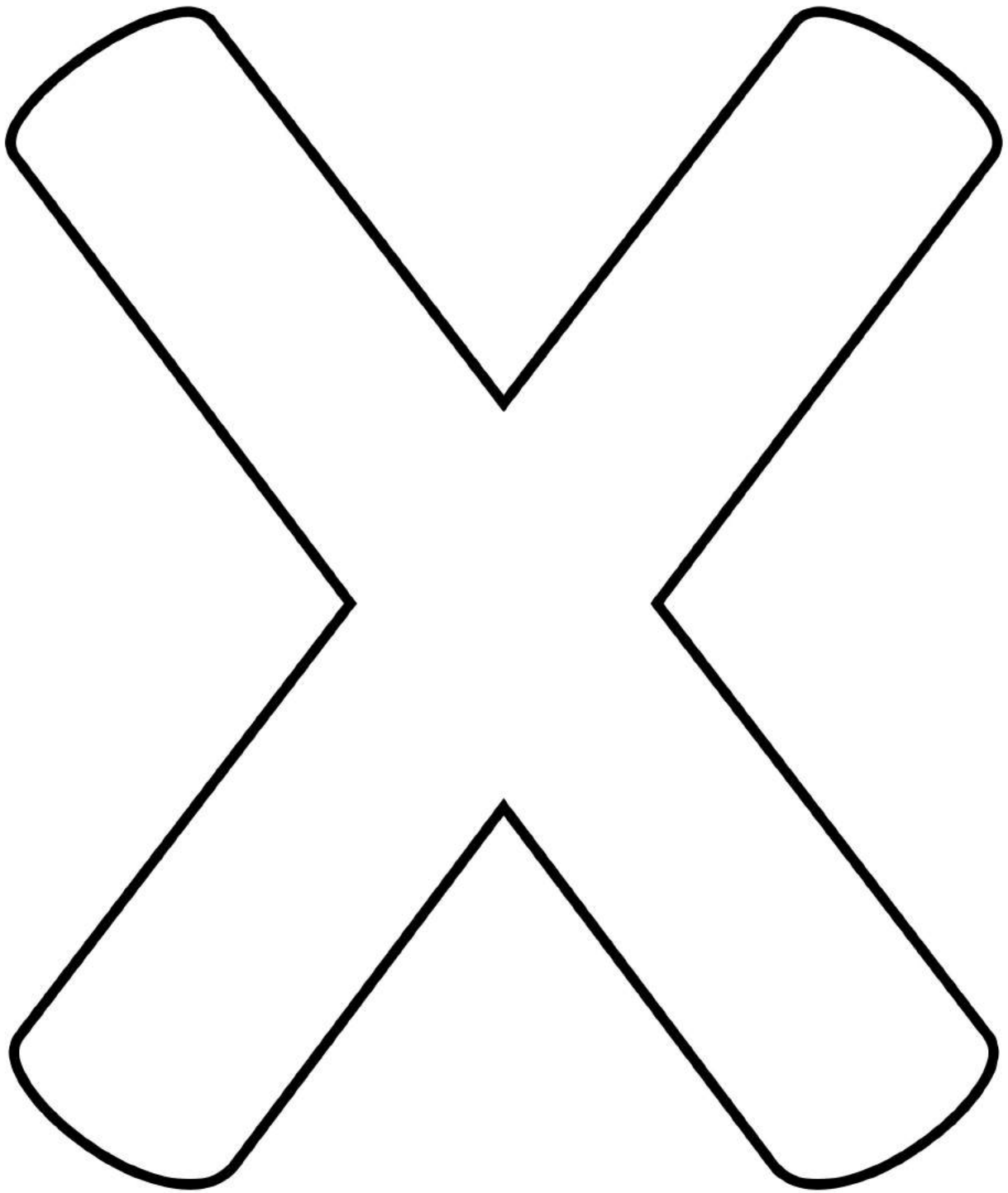



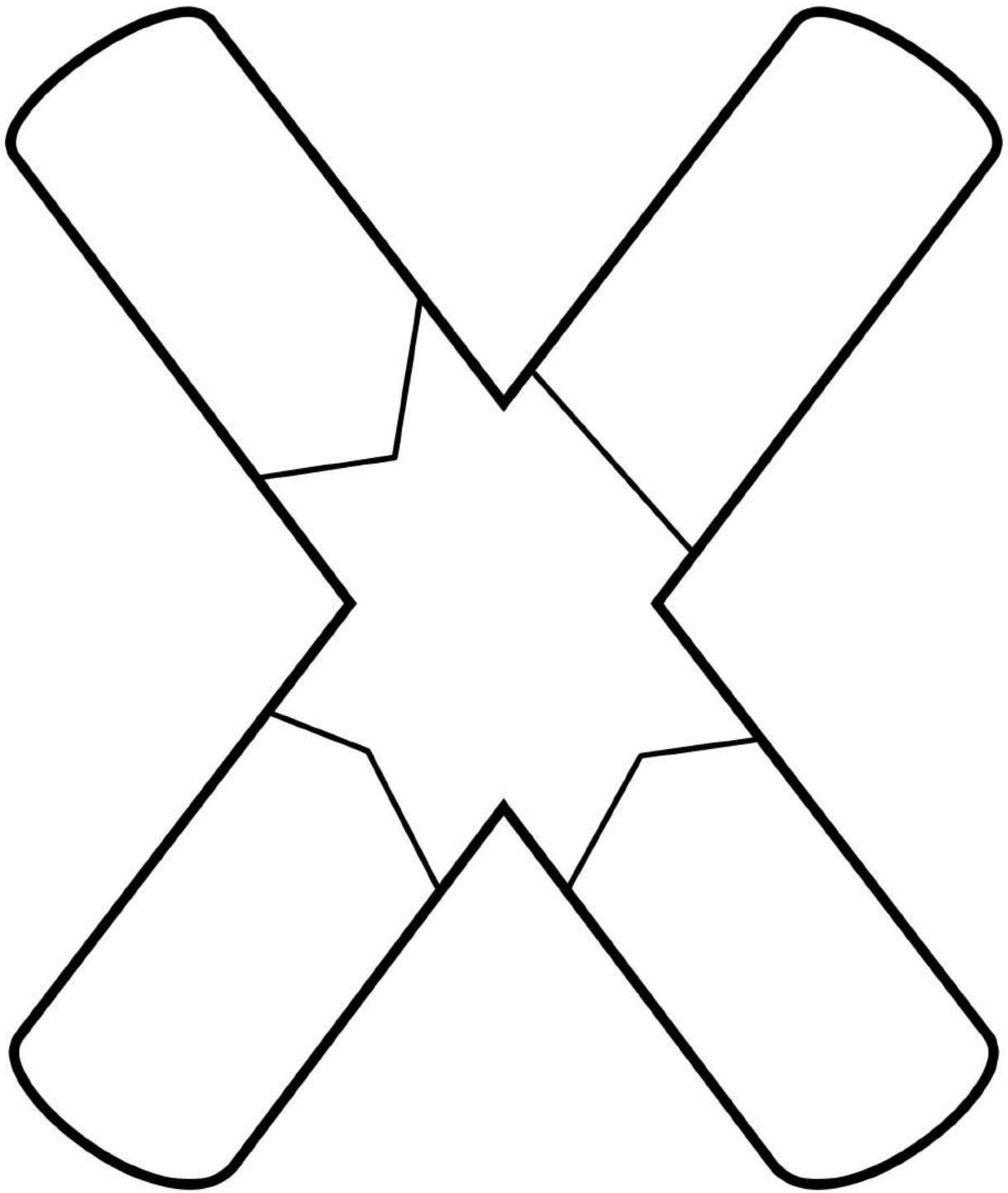

1. Write

2. Cut Out 

NAME : _____

X X

X X

X X

X X

X X

A B C Q U I L T

3. Color

4. Cut out 

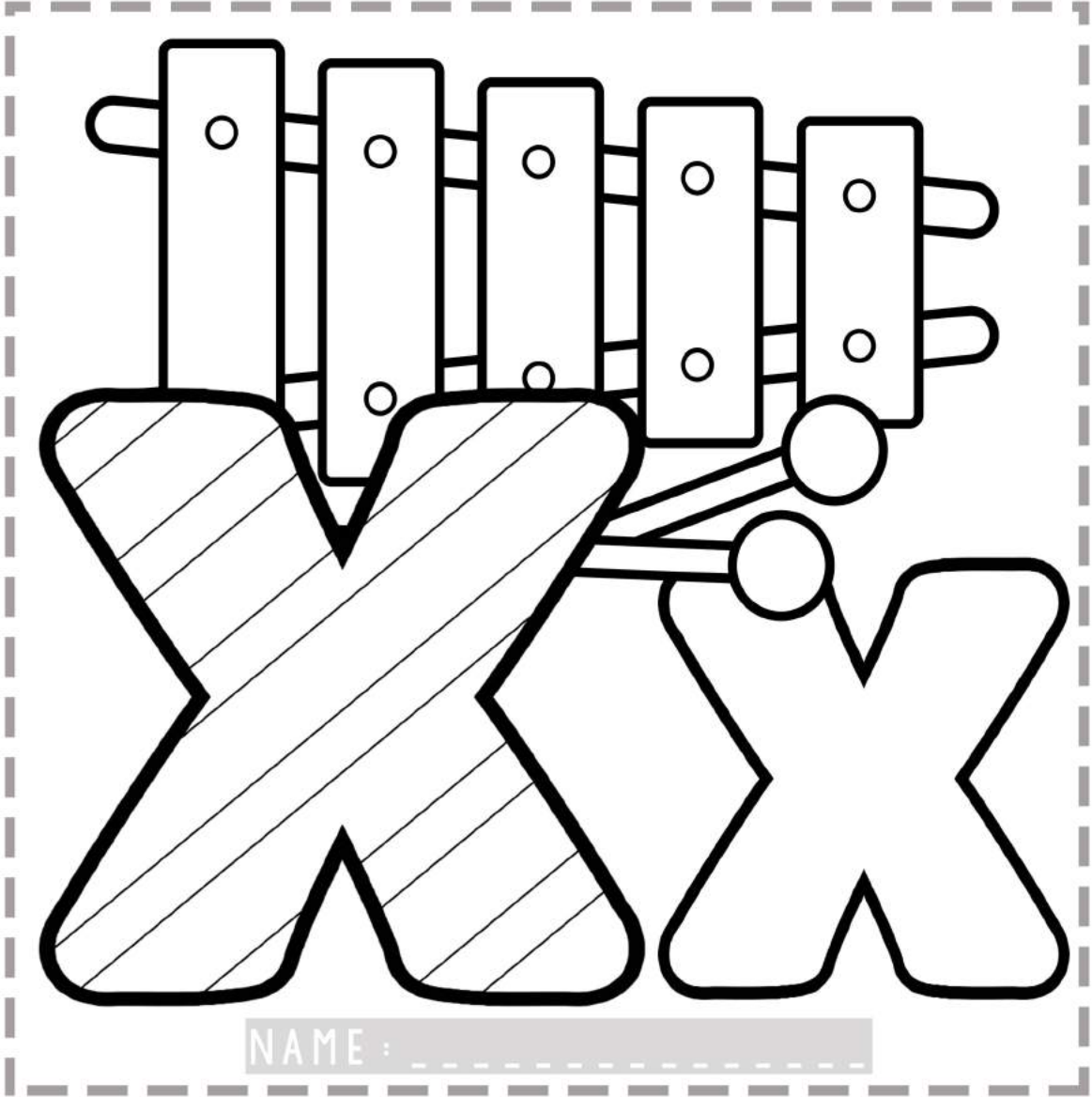

NAME : _____

Xx

Write and read words that begin with letter x.

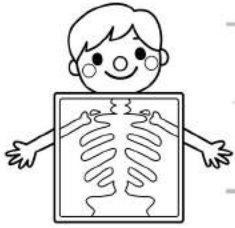

-ray -ray

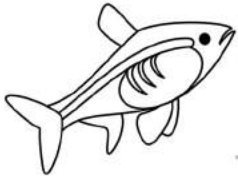

-ray fish

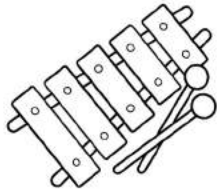

xylophone

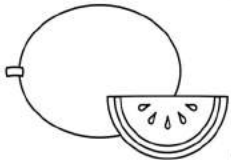

watermelon



woodpecker

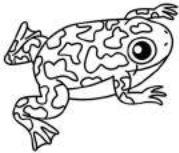

frog

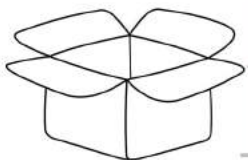

box box box



x-ray fish



x-ray



xylophone



xenops

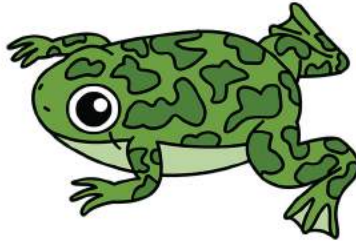

xenopus

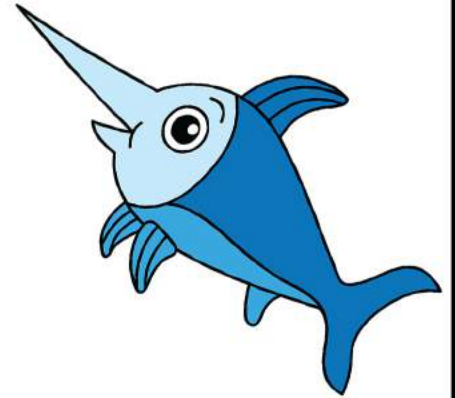

xiphias

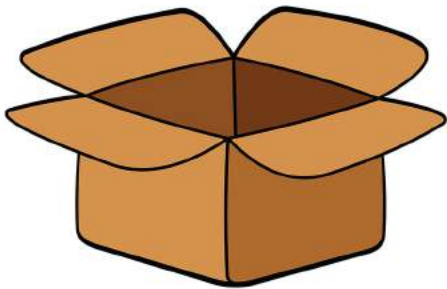

box



fax



six

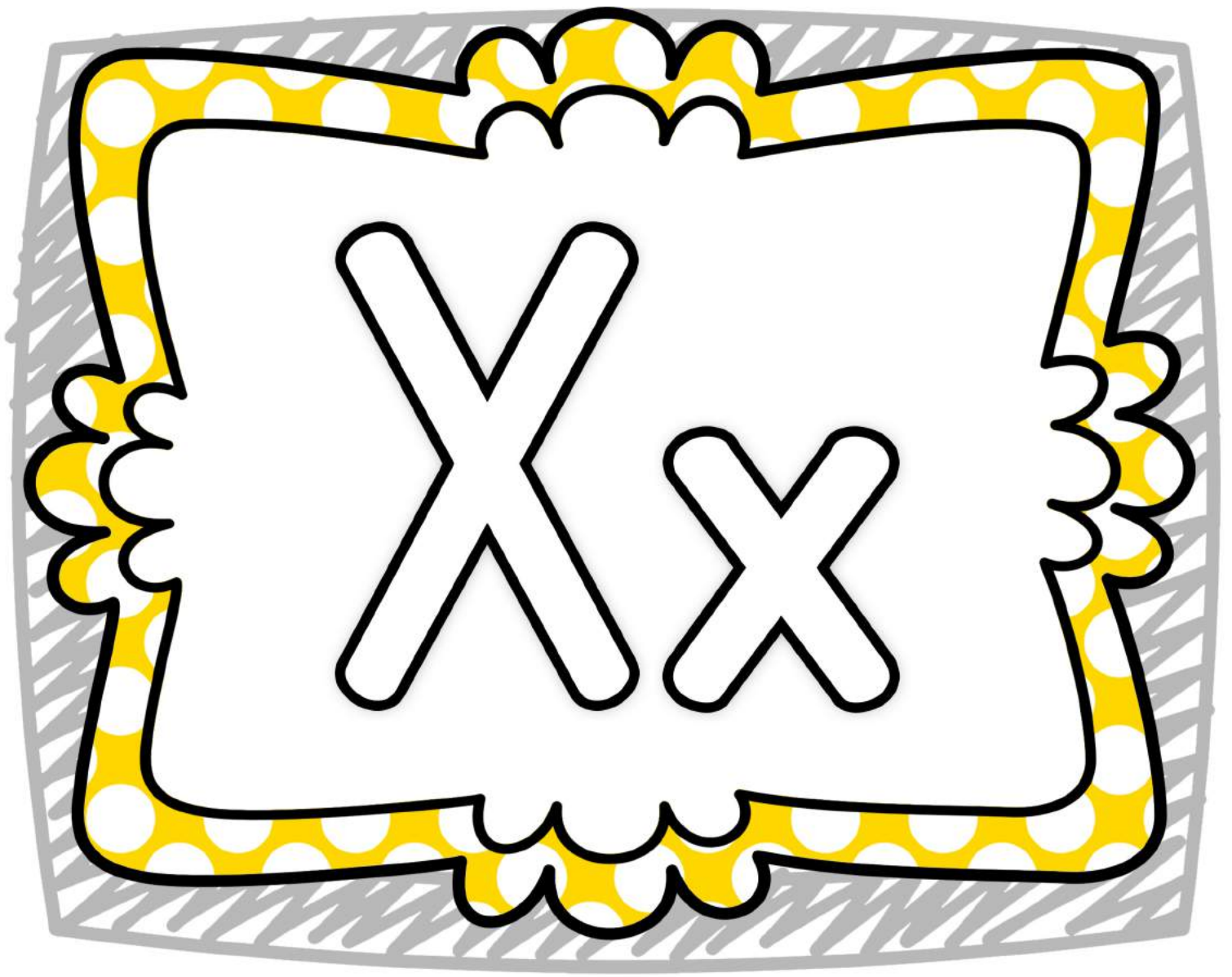

LETTER X



4 IN A ROW

			 xiang
	 xenopus	 xiphias	 xenops
 xerces			

LETTER X















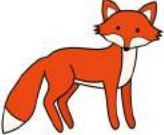

4 IN A ROW

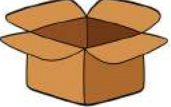
		 xerces	 xiang
	 xenopus	 xiphias	
			 xenops

LETTER X



















4 IN A ROW

			
		 xiphias	
 xerces			 xenopus
 xiang	 xenops		

LETTER X

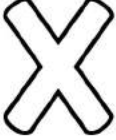

4 IN A ROW

 xenops	 xerces	 xenopus	 xiang
			 xiphias
			
			

I C A N W R I T E

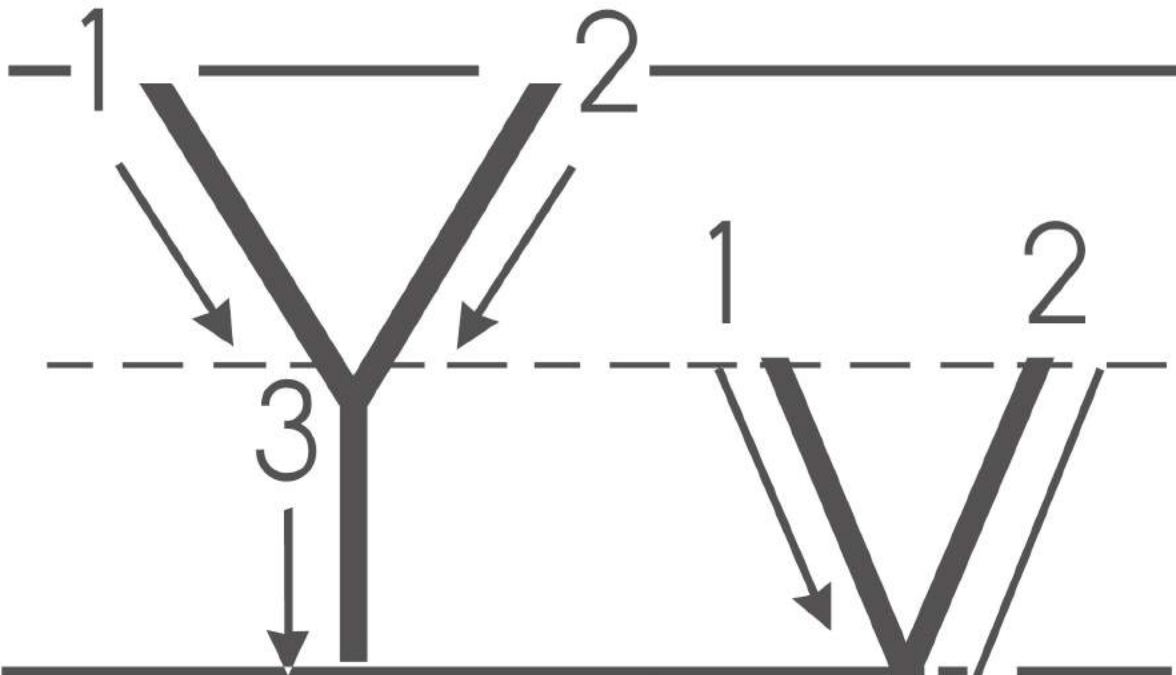

Little Slide
Pick up
Little Slide
Then Down

Little Slide
Pick up
Slide Down
with a Tail.

Yarn

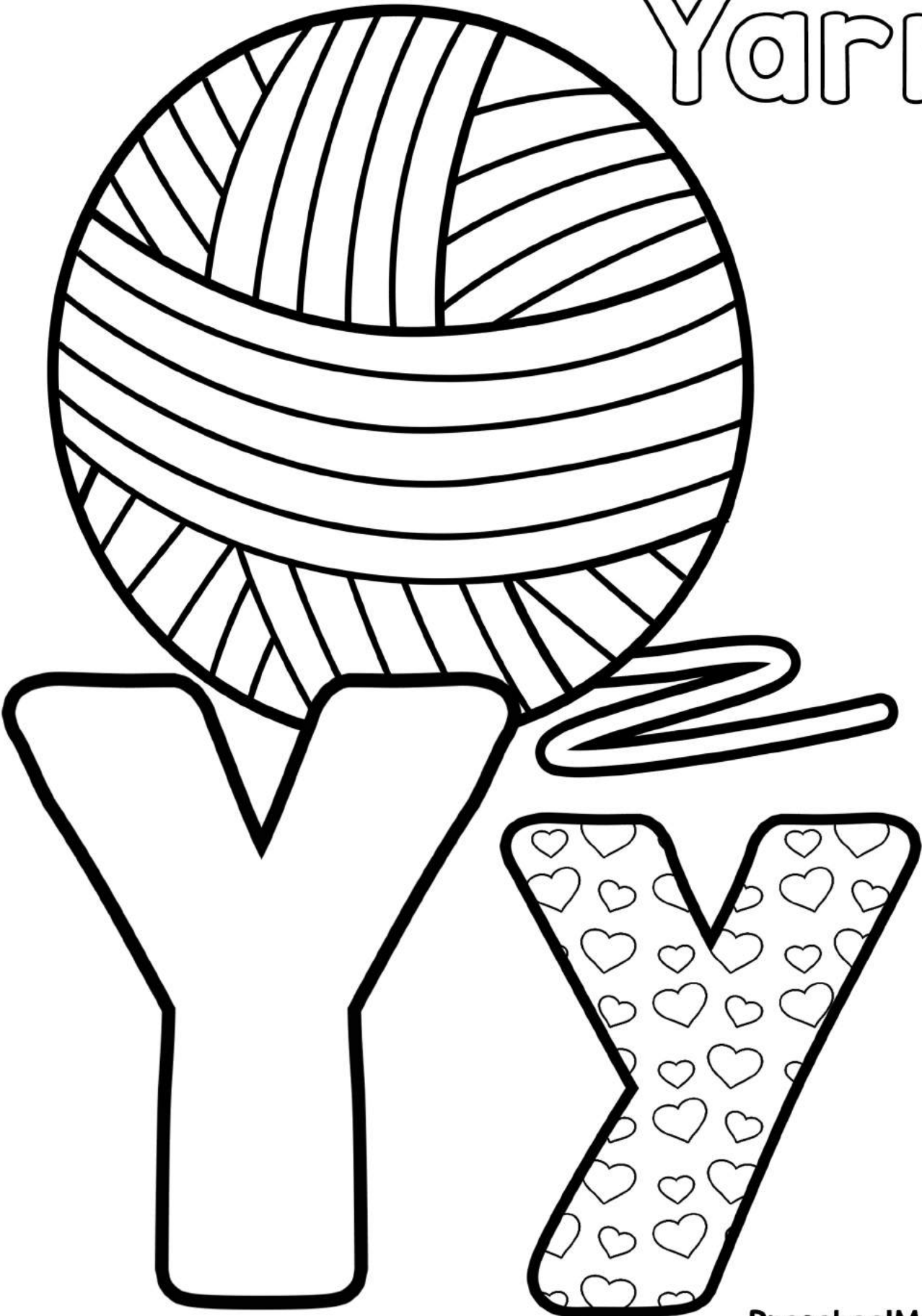

Y

y

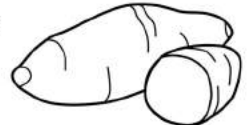
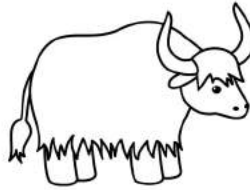
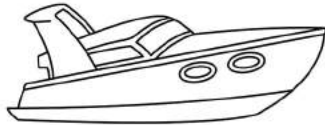
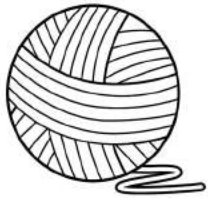
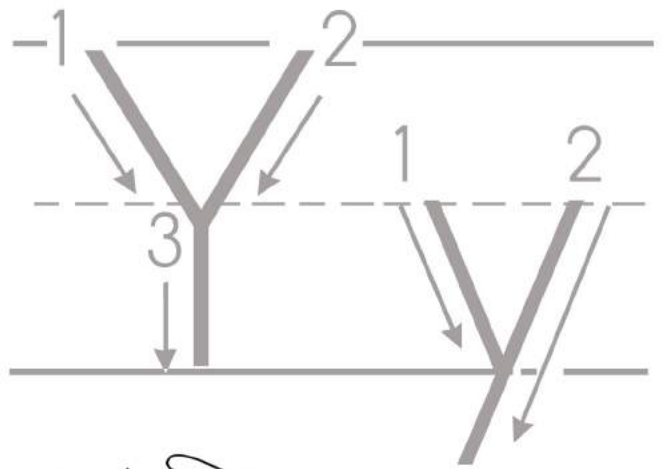

yarn

yacht

yak

yogurt

yam

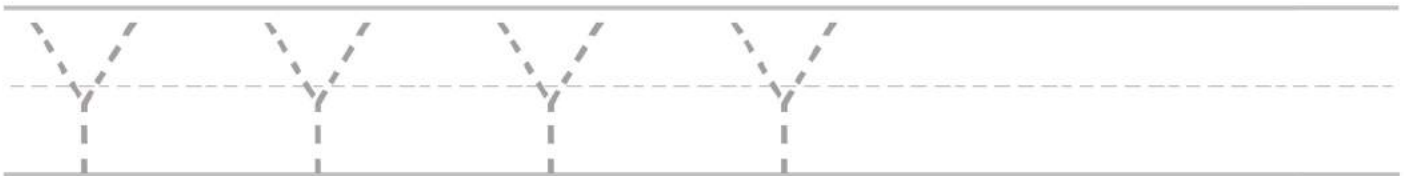

Draw huge waves for the yacht

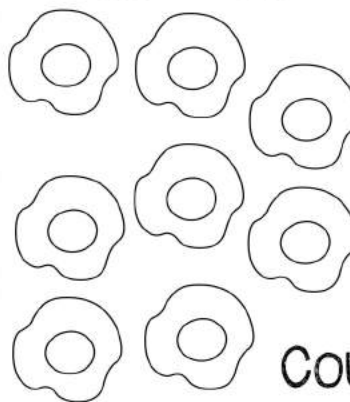
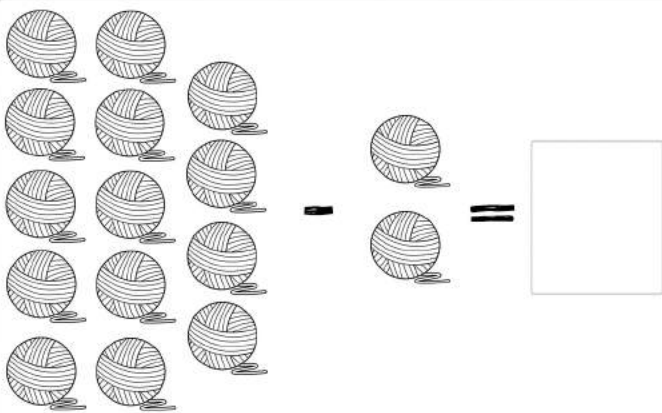
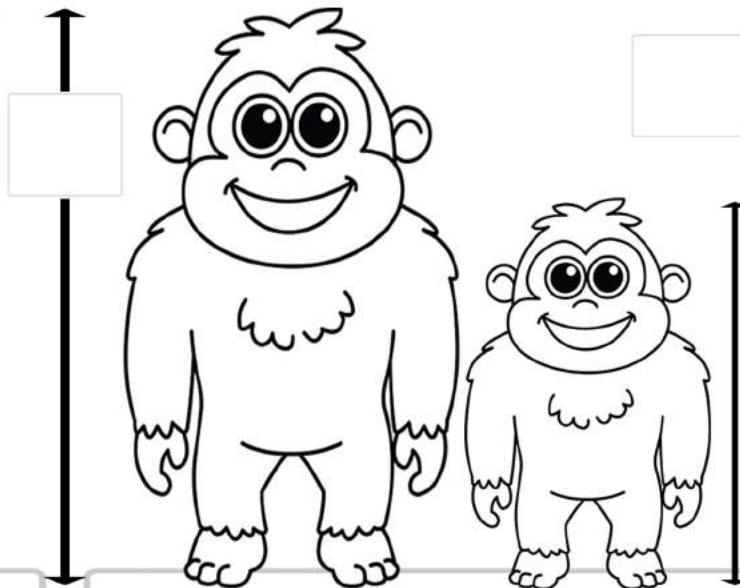
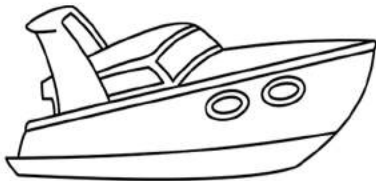

Count & Tally

$$14 - 1 = \square$$

$$14 - 2 = \square$$

$$\begin{array}{r} 14 \\ - 3 \\ \hline \square \end{array}$$

$$\begin{array}{r} 14 \\ - 4 \\ \hline \square \end{array}$$

Circle what comes next:

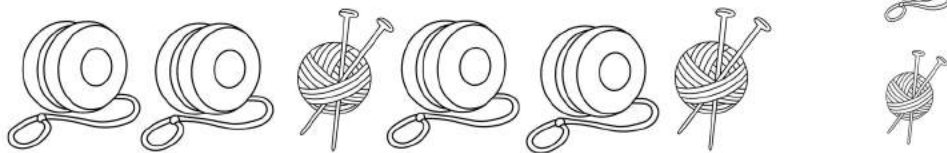

Yolanda has eight yaks on her farm. Last week two yaks ran off. How many yaks does Yolanda have left?

Draw: $14 - 3 = 11$

Y y

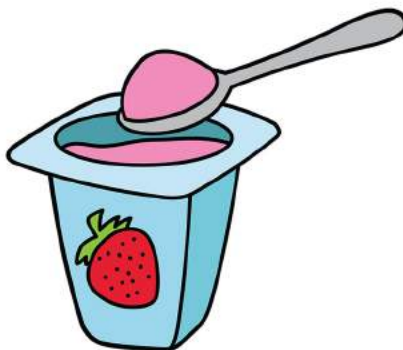
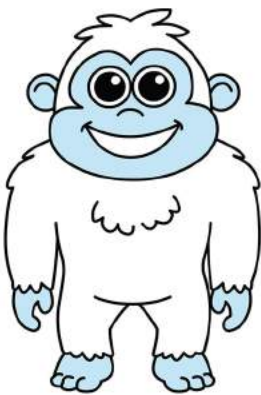
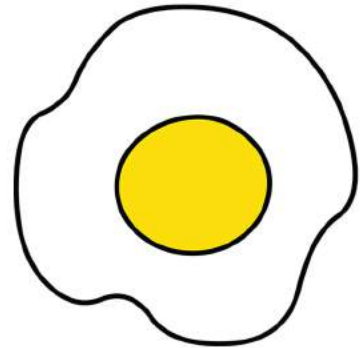
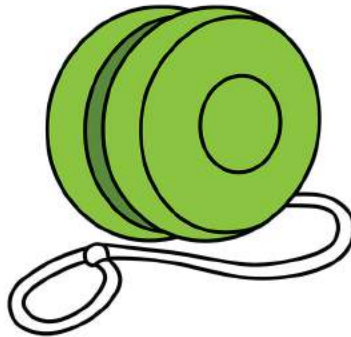
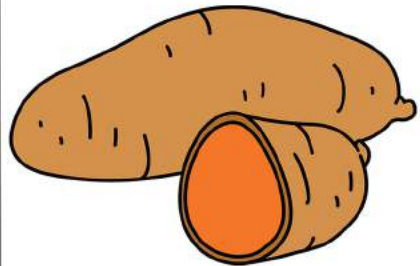
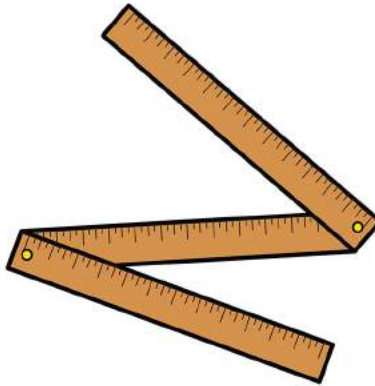
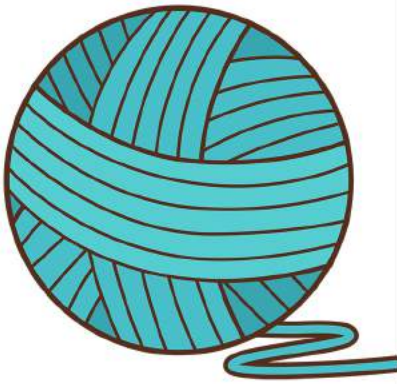
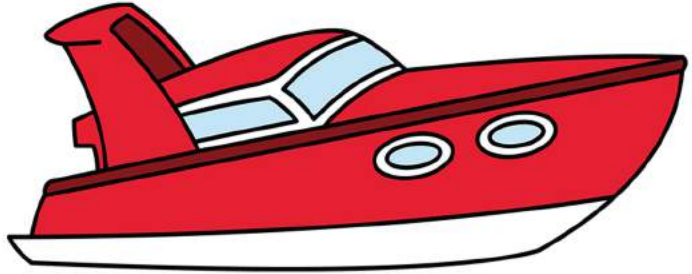



I

C A N

C O L O R

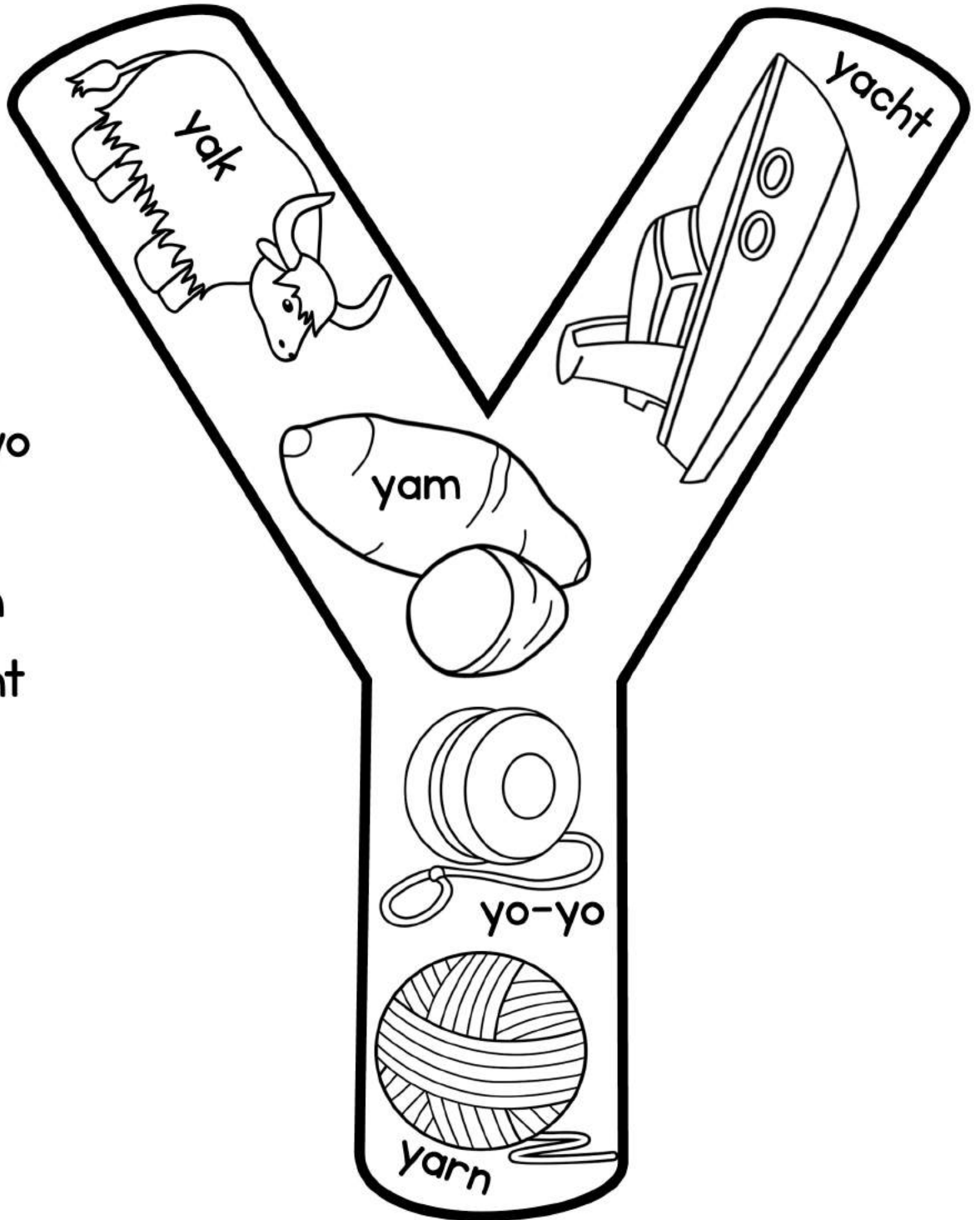
words with:



 = yo-yo

 = yam

 = yarn

 = yacht

 = yak

NAME : _____

Yy

Write and read words that begin with letter y.

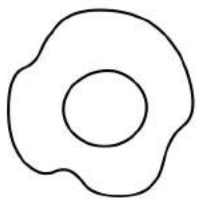

yolk yolk yolk



yo-yo yo-yo



yarn yarn



yak yak yak



yam yam yam

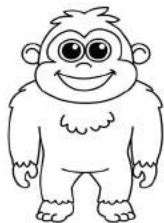

yeti yeti yeti



yacht yacht

NAME : _____

Yy

Write and read words that begin with letter y.

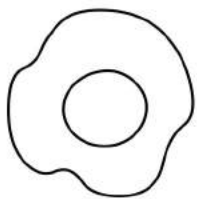

Yolk Yolk



Yo-yo Yo-yo



Yarn Yarn

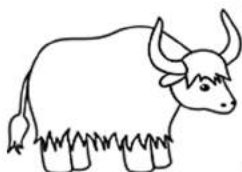

Yak Yak Yak



Yam Yam

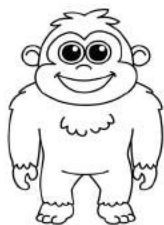

Yeti Yeti

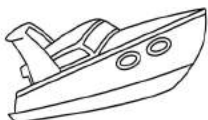

Yacht Yacht

NAME : _____

RACE TO THE TOP

Use a paperclip and a pencil to complete the spinner.

Y	Y
Y	Y
Y	Y
Y	Y
Y	Y
Y	Y
Y	Y
Y	Y
Y	Y
Y	Y

SPIN

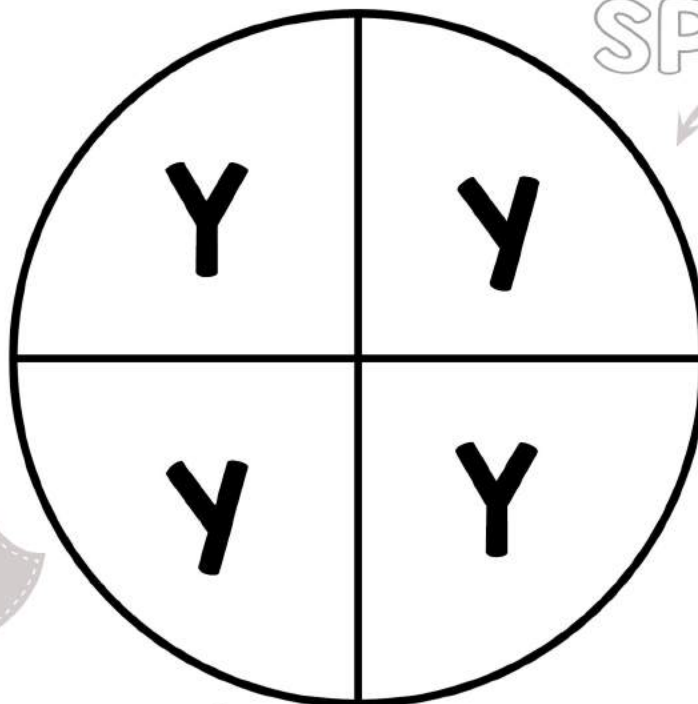

Record

Report:

How many spins landed on Y?

How many spins landed on y?

Which had more?

Write an inequality: **>**

How many spins total?

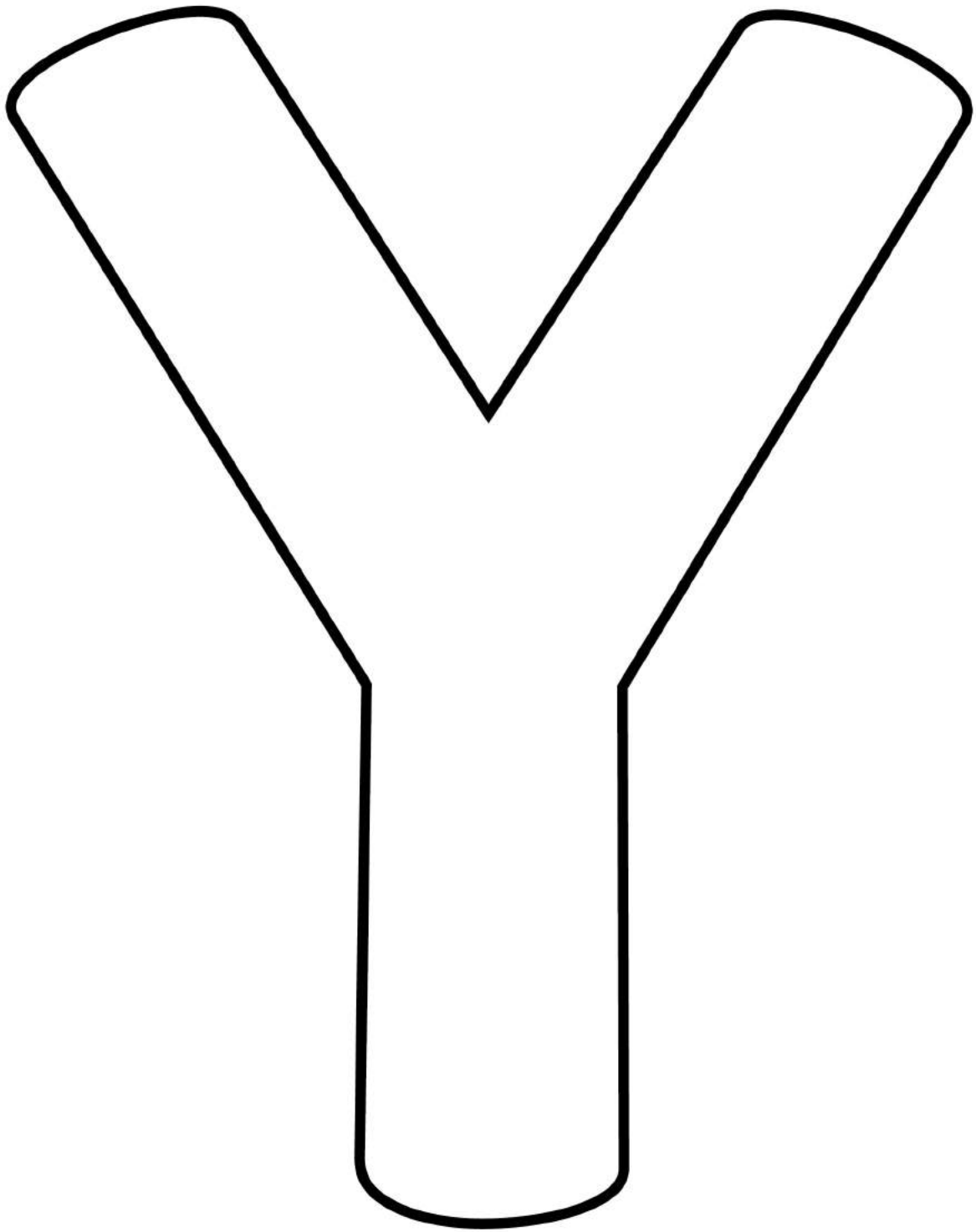

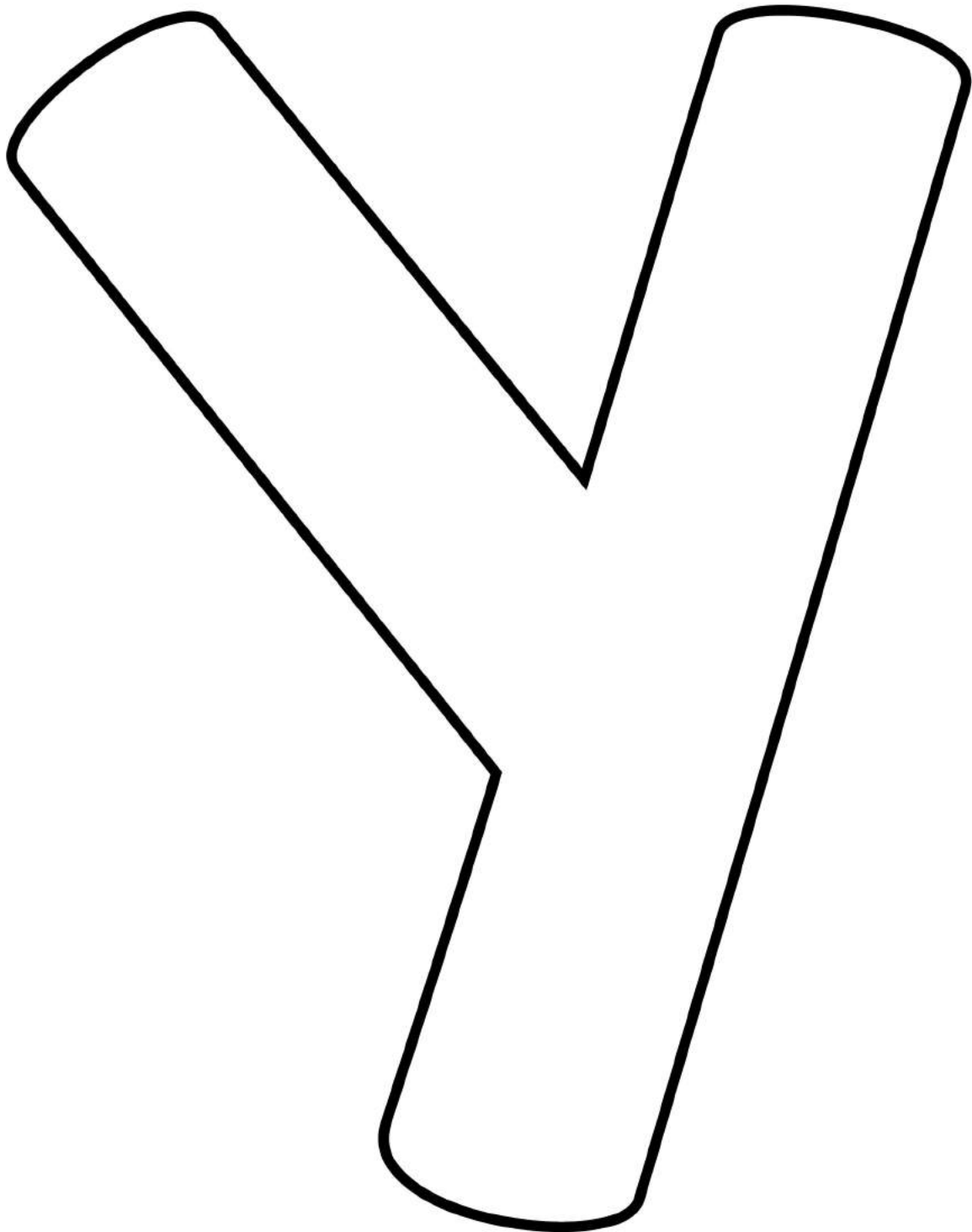

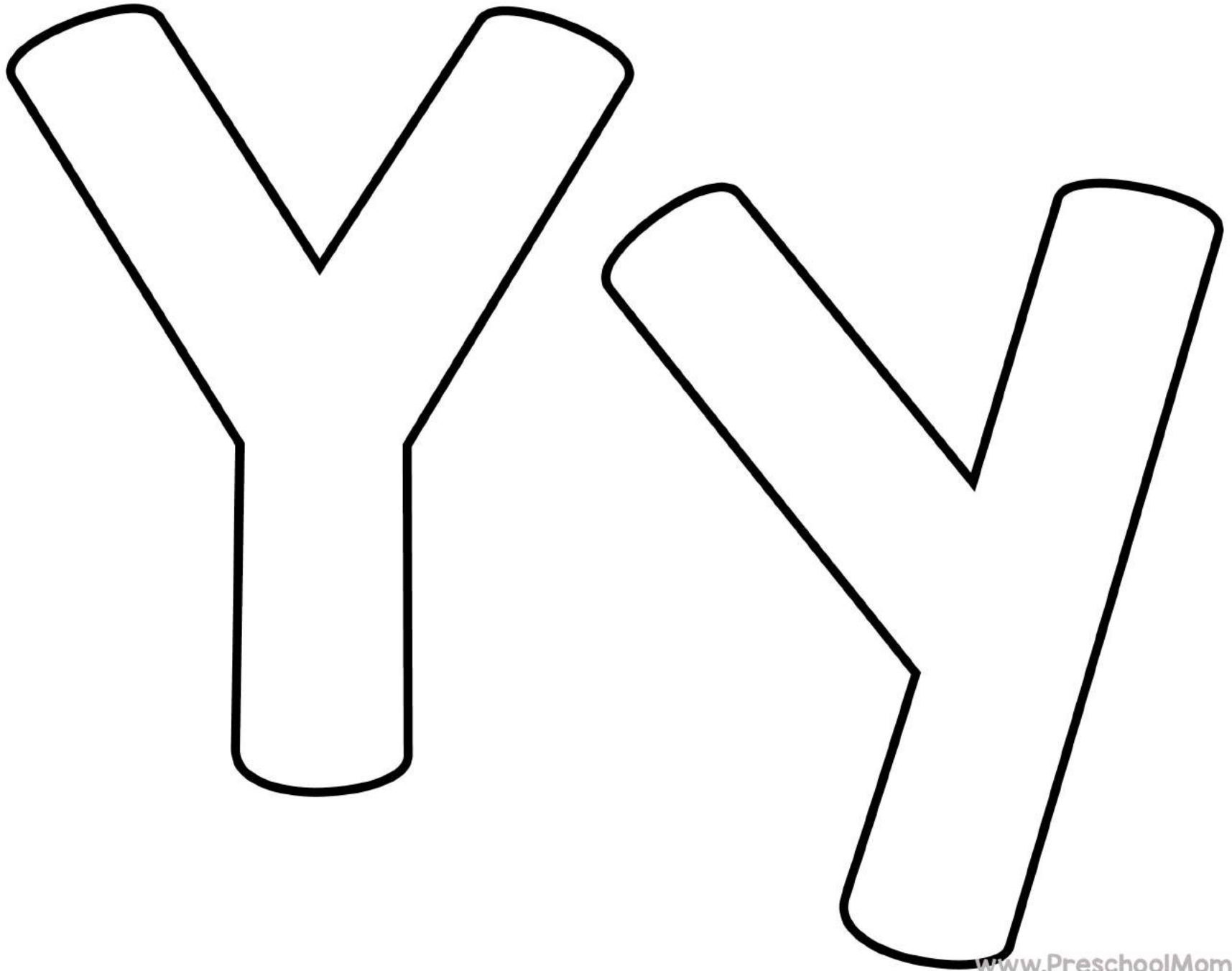

★ I ★

★ C ★ ★ A ★ ★ N ★

★ F ★ ★ I ★ ★ N ★ ★ D ★

the letter:

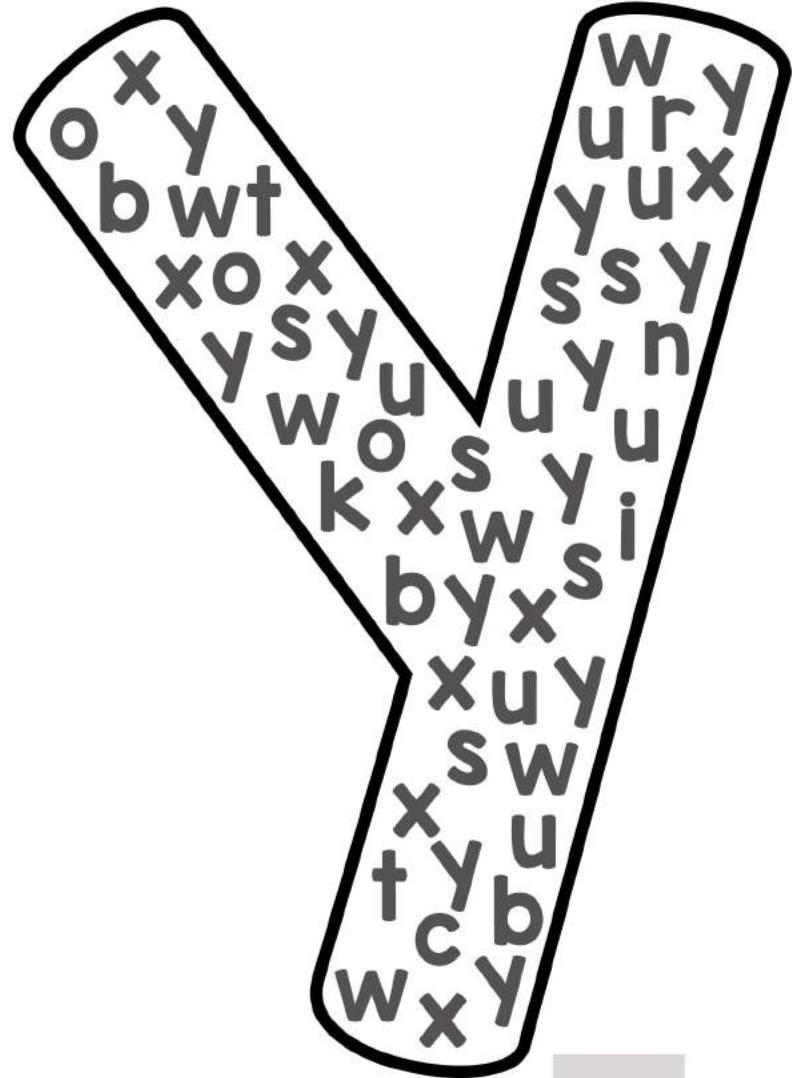
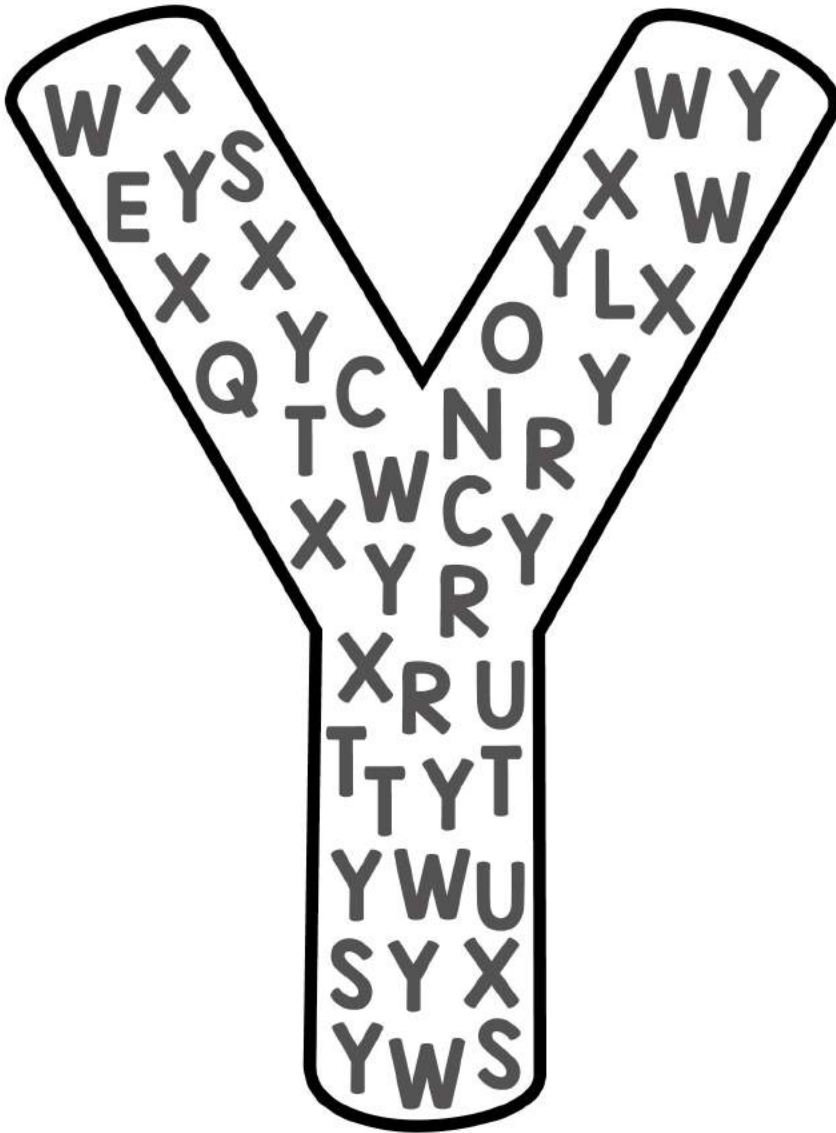

How Many?

How Many?

TRACE

NAME : _____





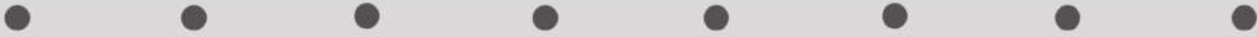
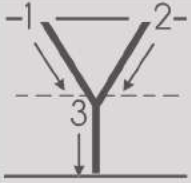

Color one for each row of letters you complete

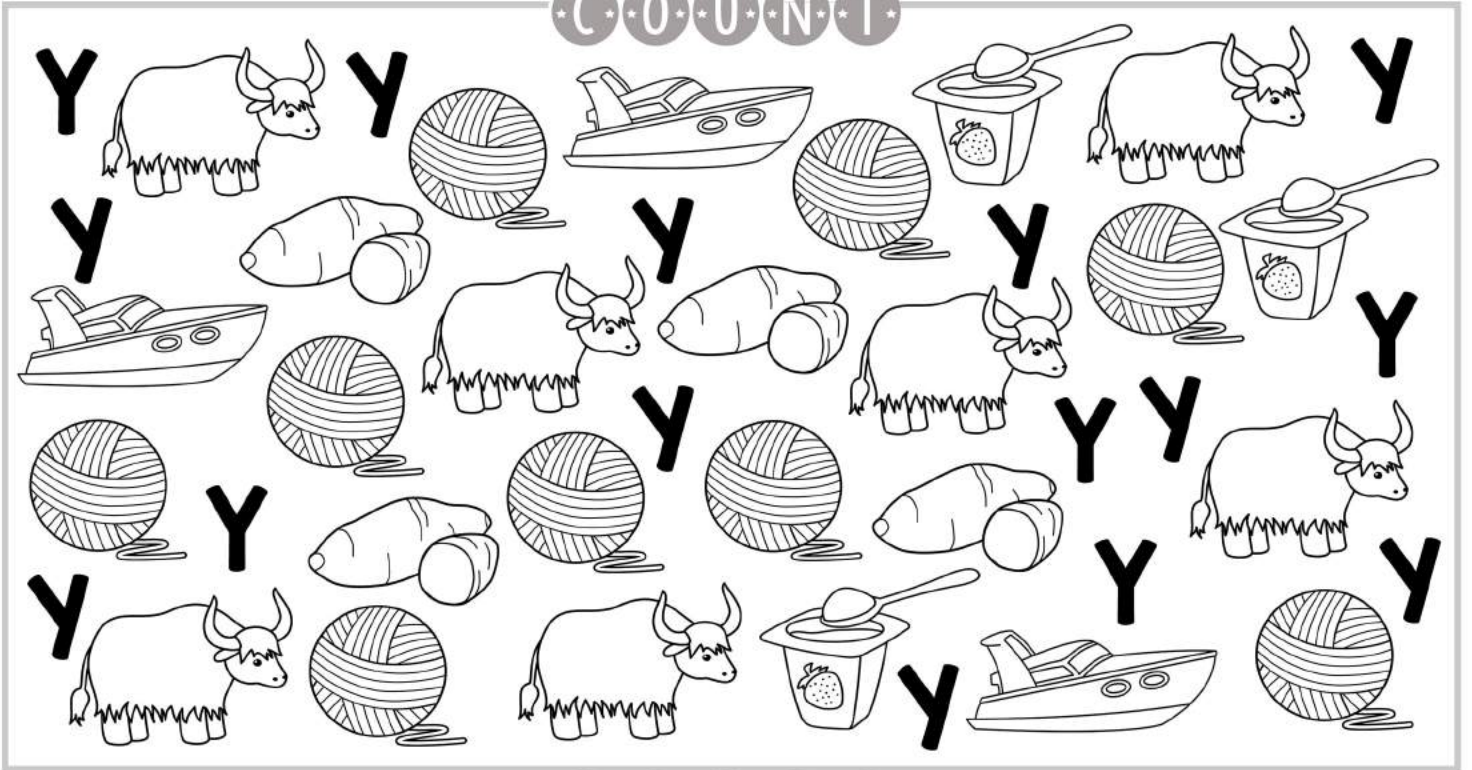

C · O · U · N · T

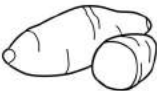

G · R · A · P · H

Y	Y					

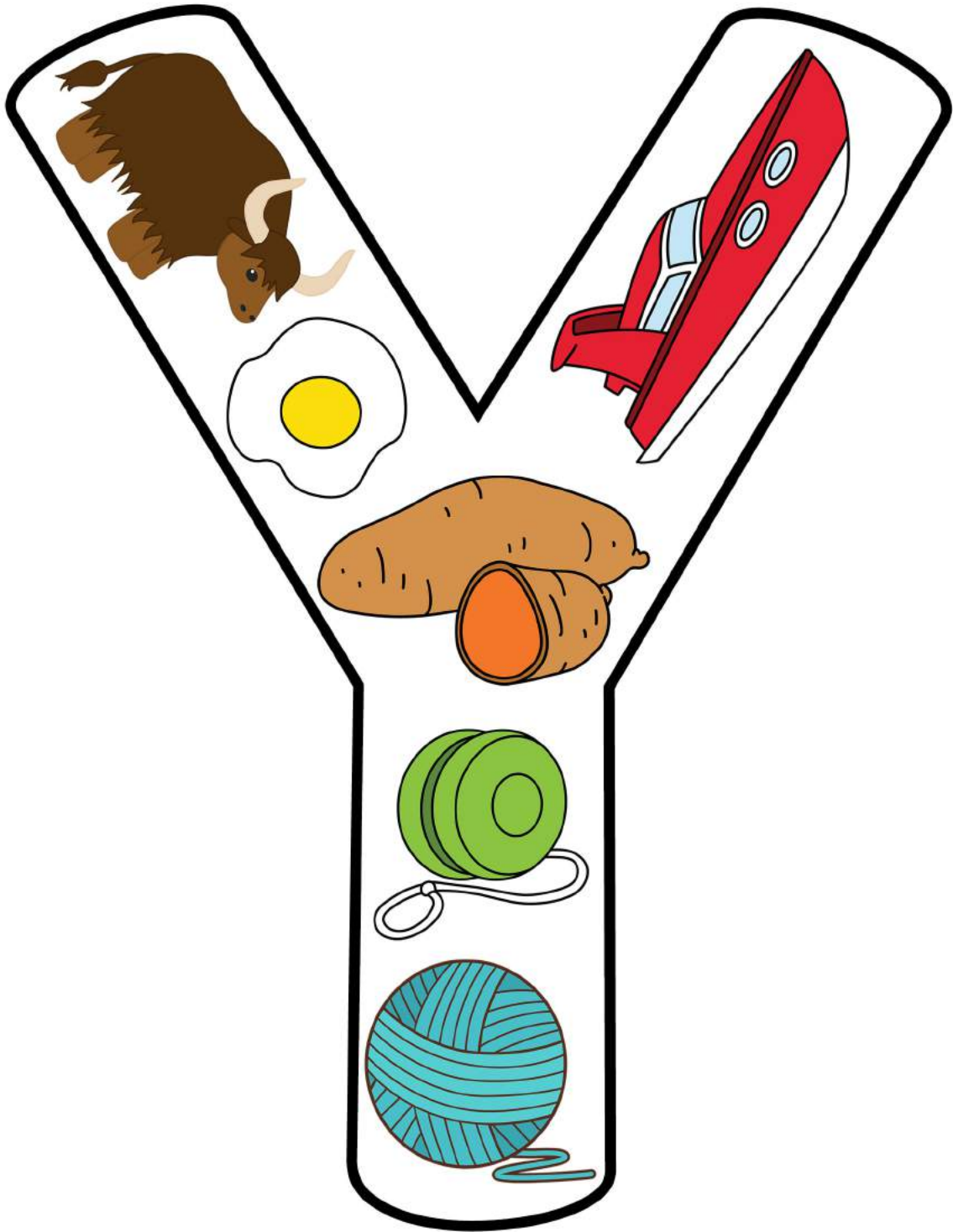

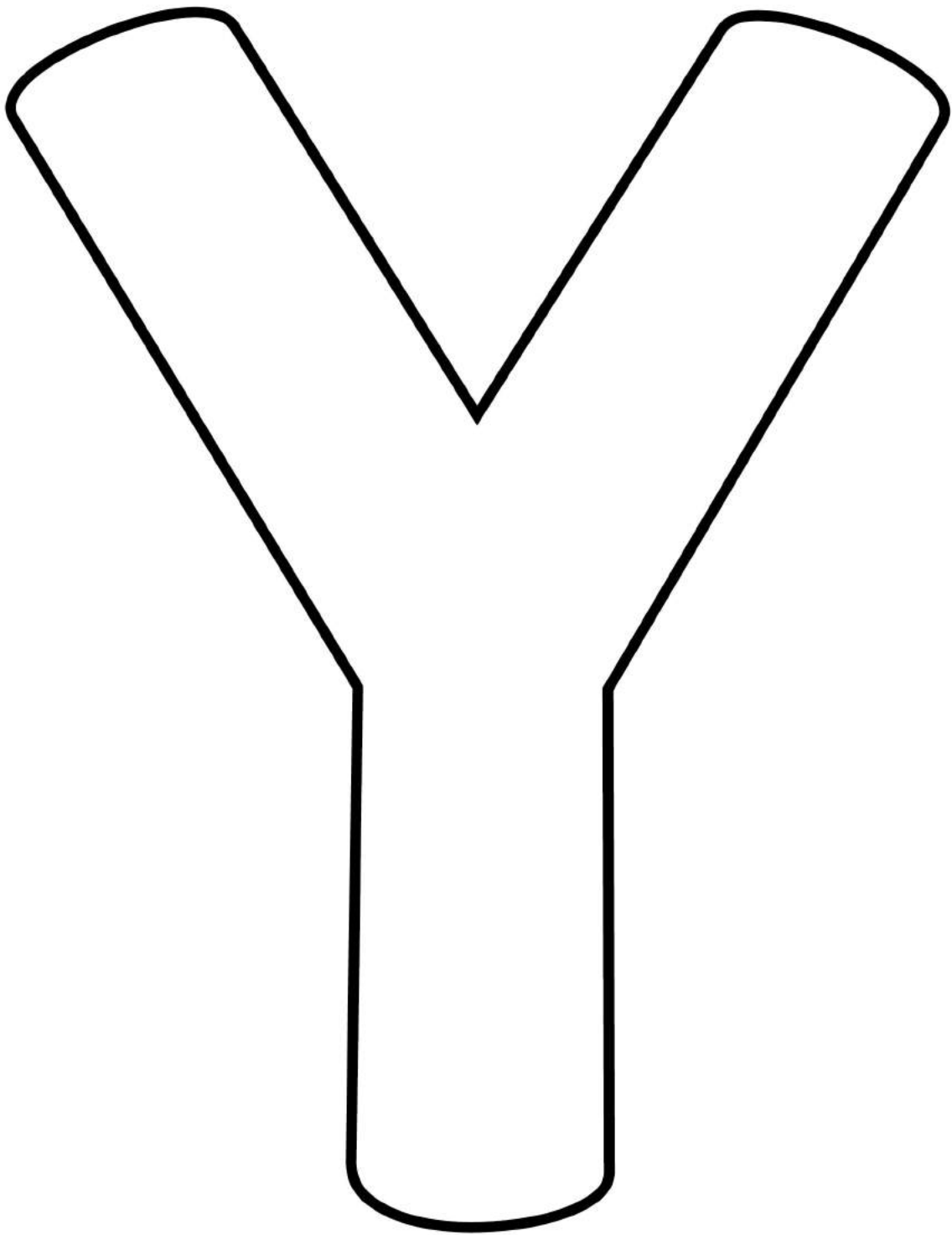

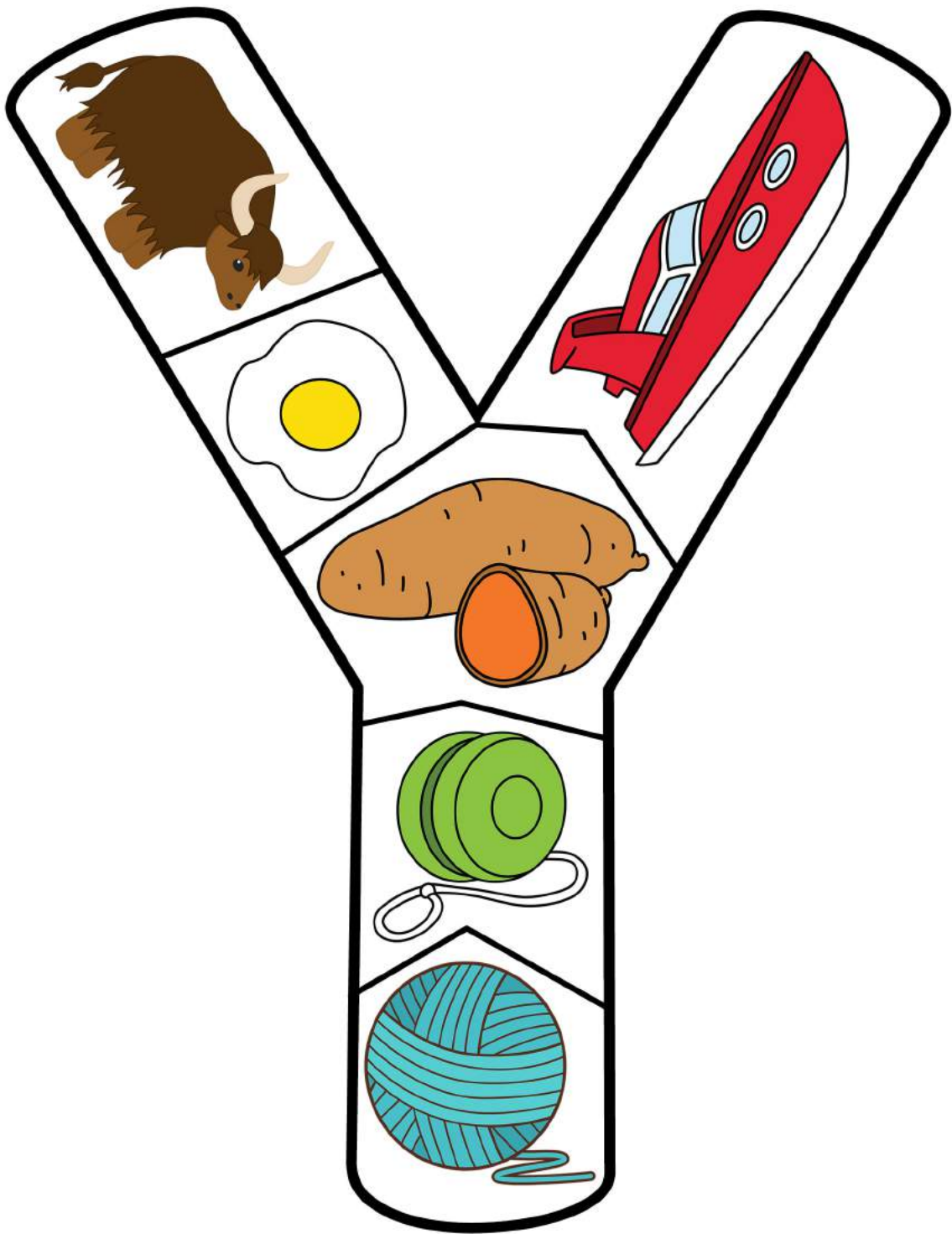

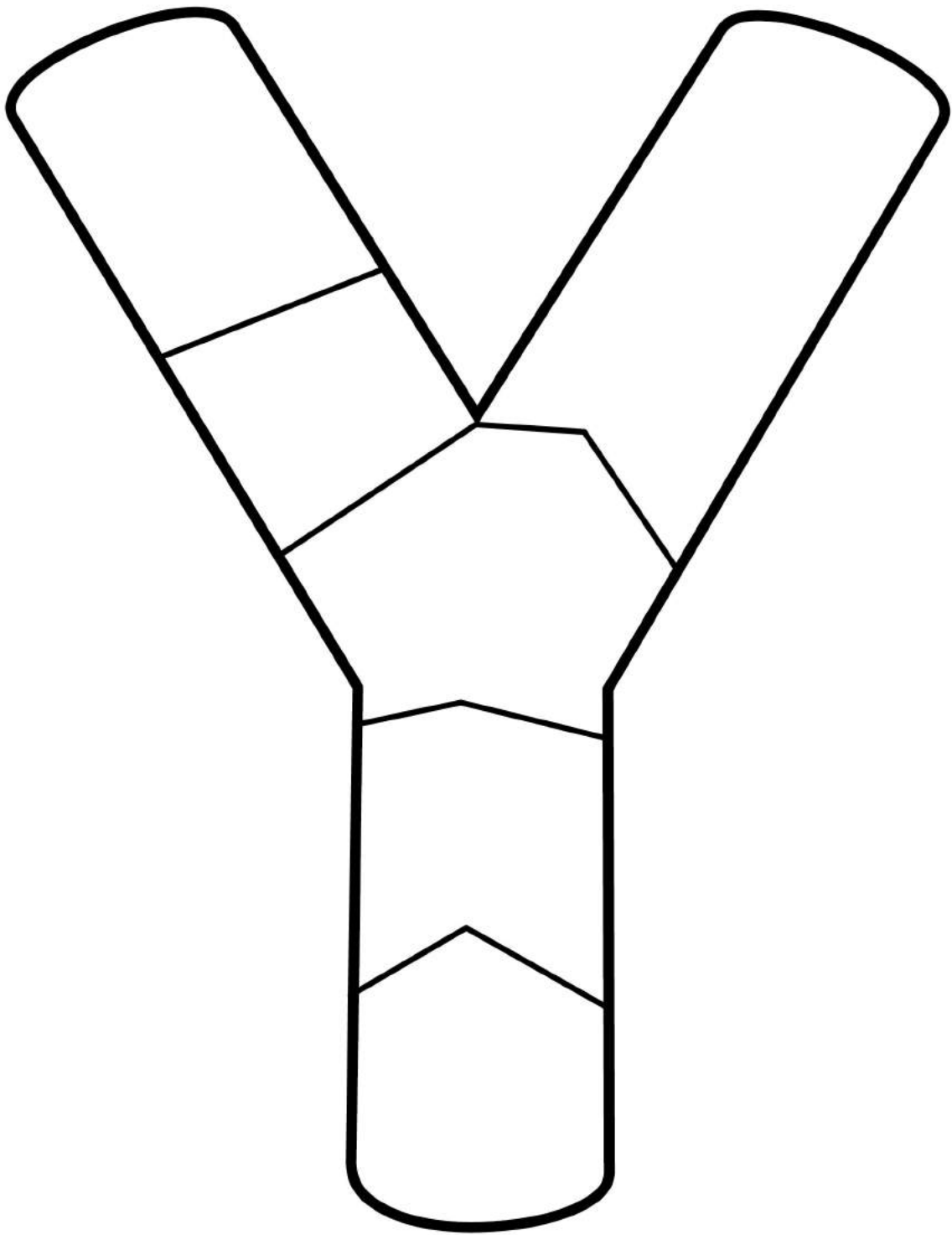

1. Write

2. Cut Out 

NAME : _____

Y Y

Y Y

Y Y

Y Y

Y Y

A B C Q U I L T

3. Color

4. Cut out 



NAME : _____

Yy

Write and read words that begin with letter y.



olk olk olk



o-yo o-yo

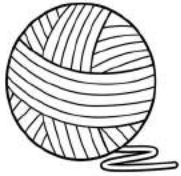

arn arn

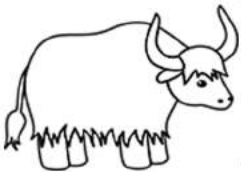

ak ak ak



am am am

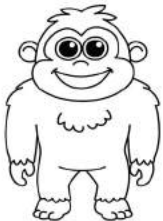

eti eti eti

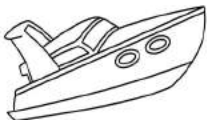

acht acht

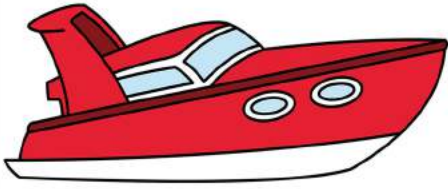

yacht



yo-yo

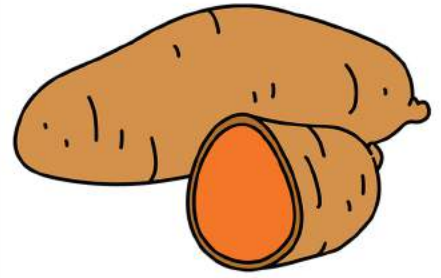

yam

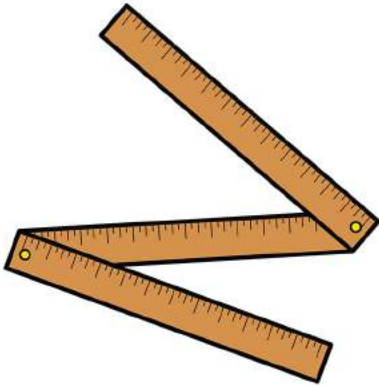

yardstick



yule log

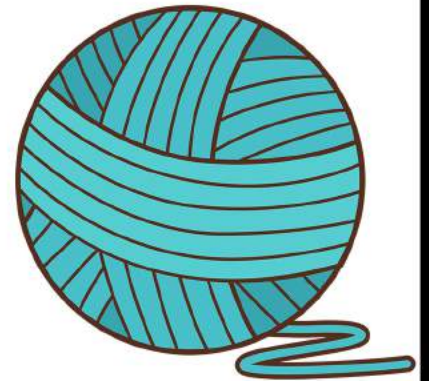

yarn

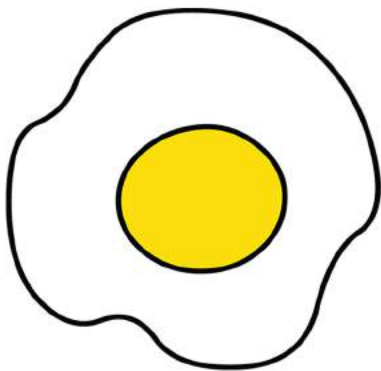

yolk

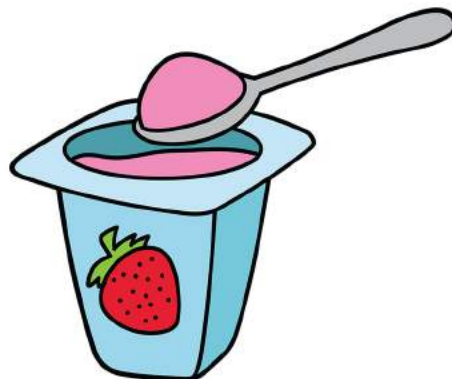

yogurt

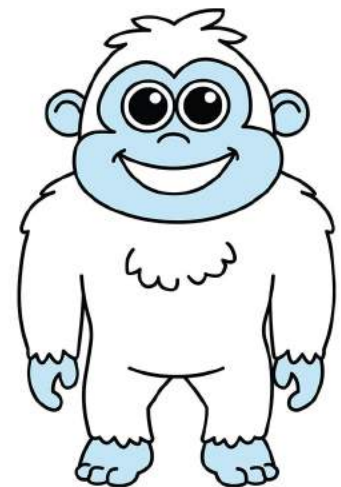

yeti

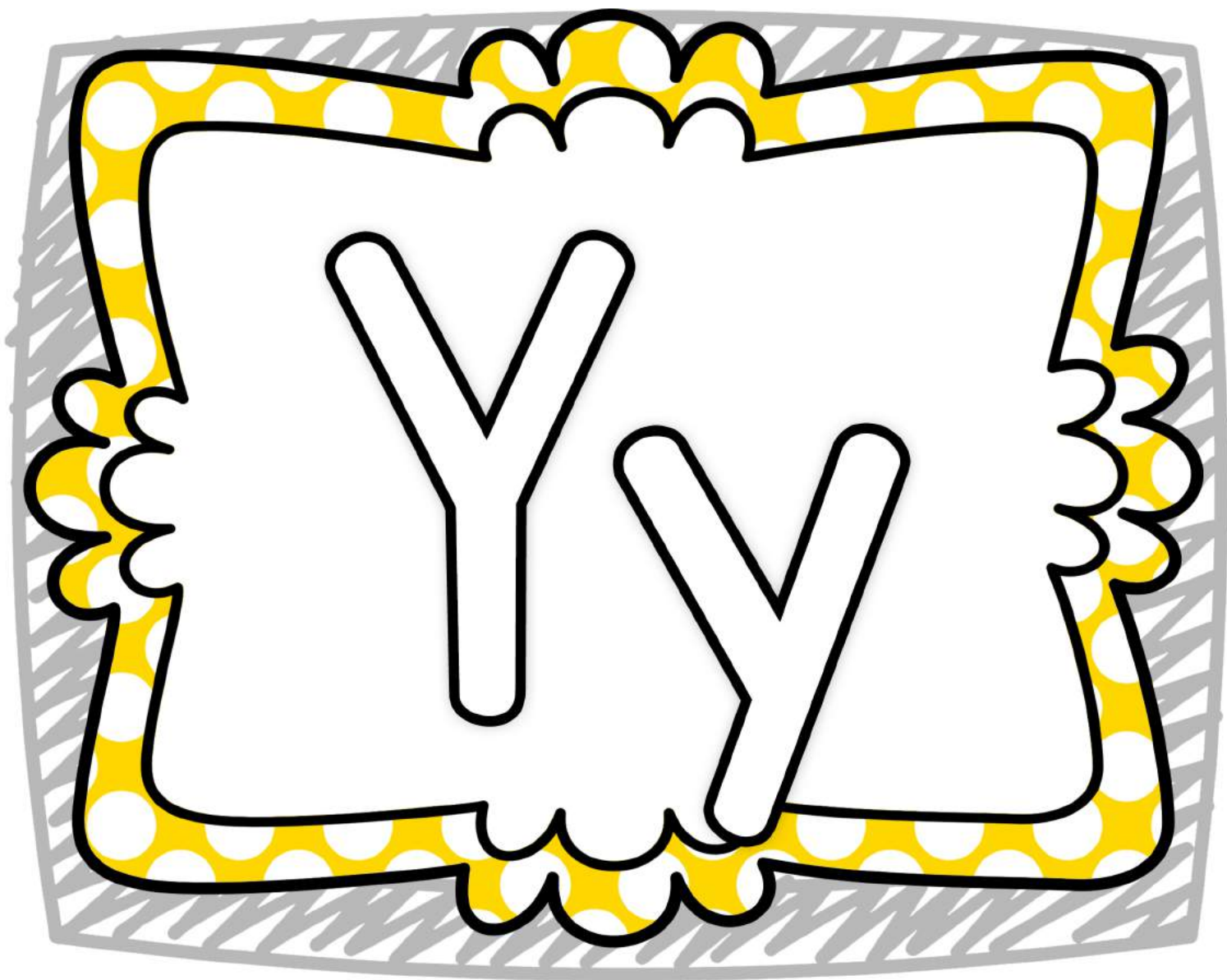

LETTER Y



4 IN A ROW

LETTER Y











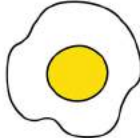



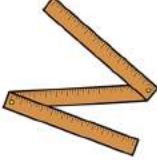

4 IN A ROW

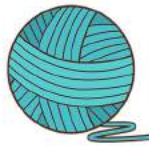
LETTER Y













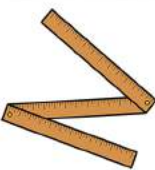



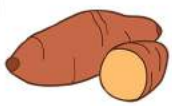

4 IN A ROW

LETTER Y



4 IN A ROW

I C A N W R I T E

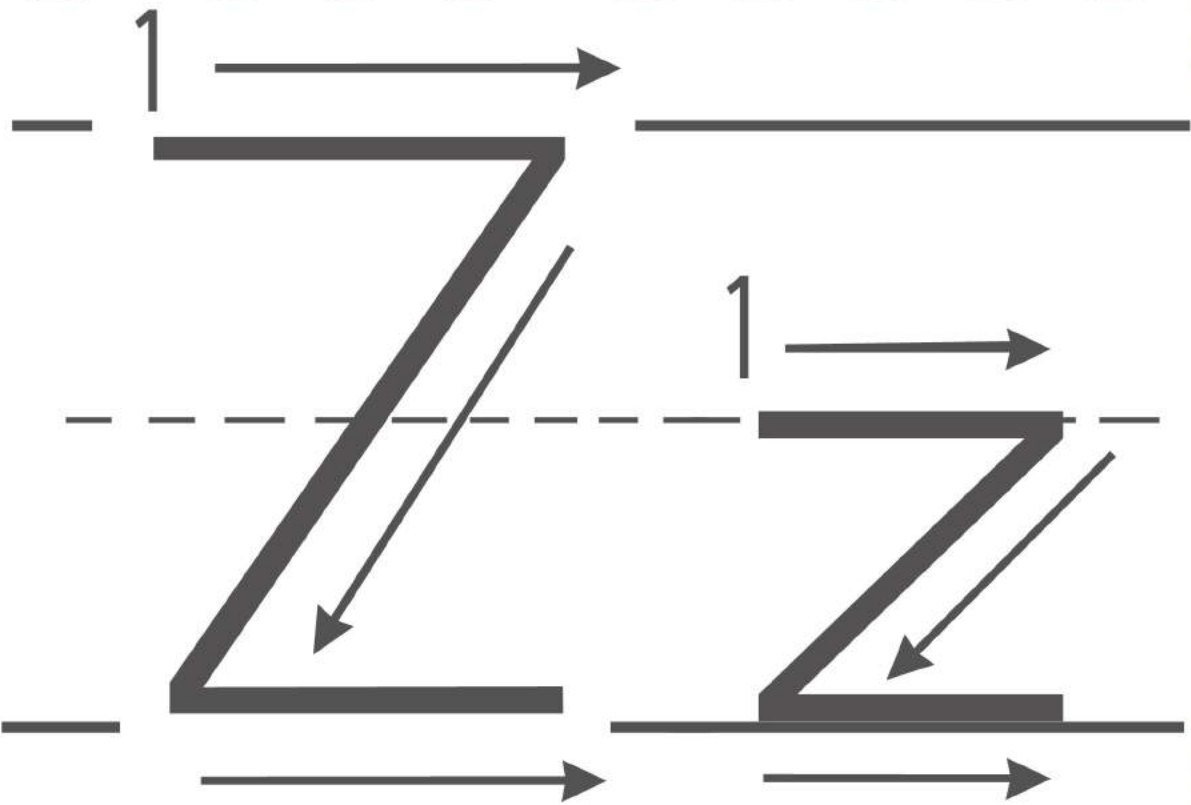

Slide Over
Slide Back
Slide Over

Slide Over
Slide Back
Slide Over

Zebra

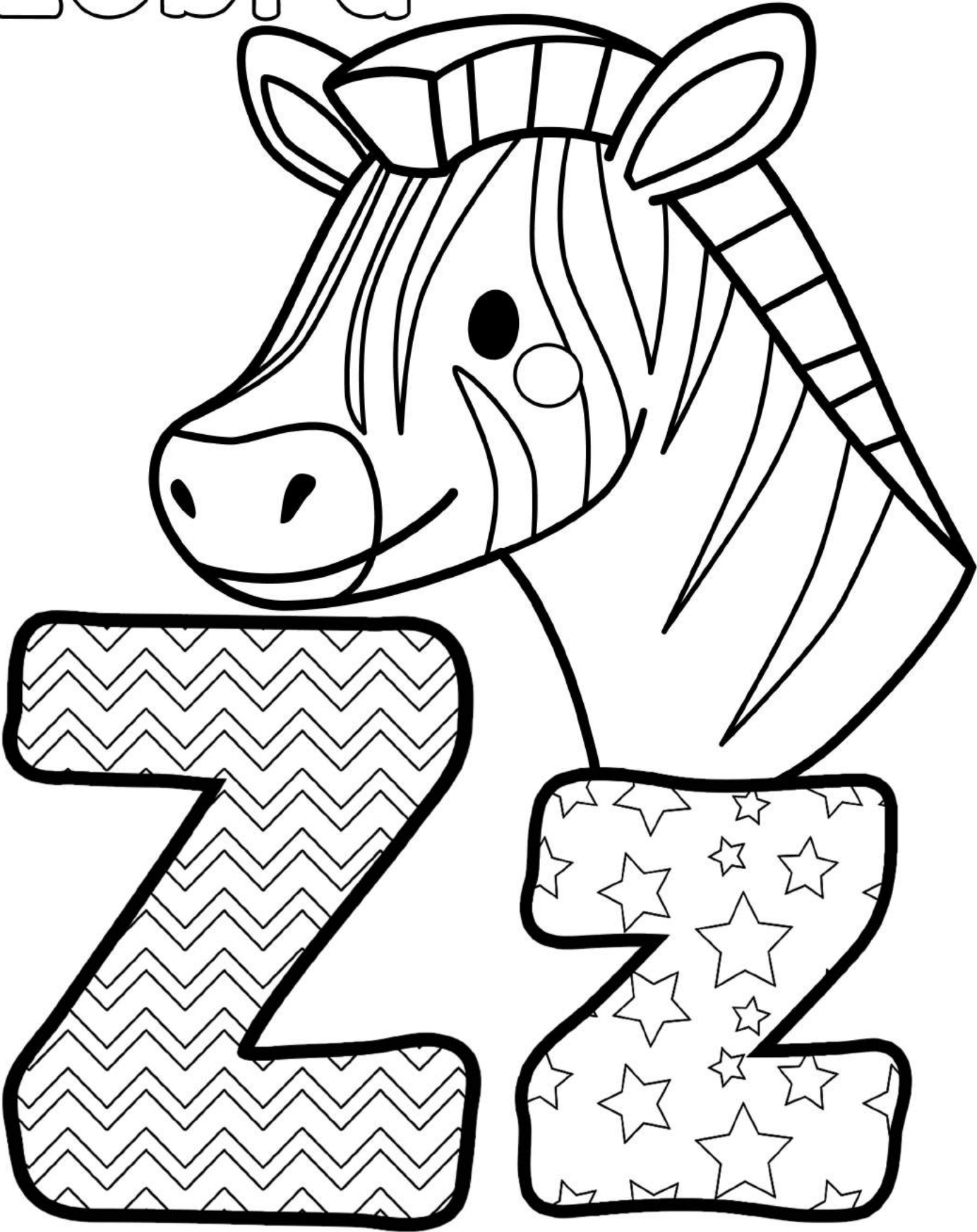

Z z

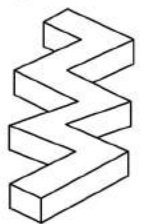
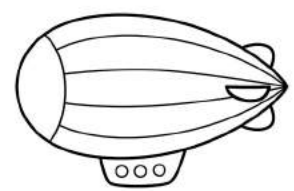
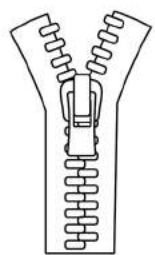
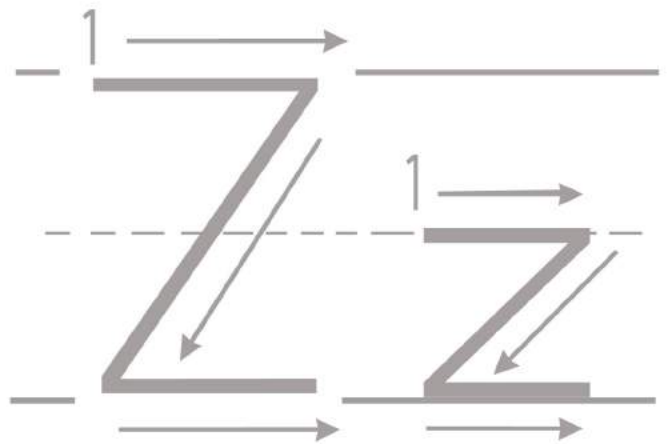

zoo zebra zipper zucchini zeppelin zig-zag

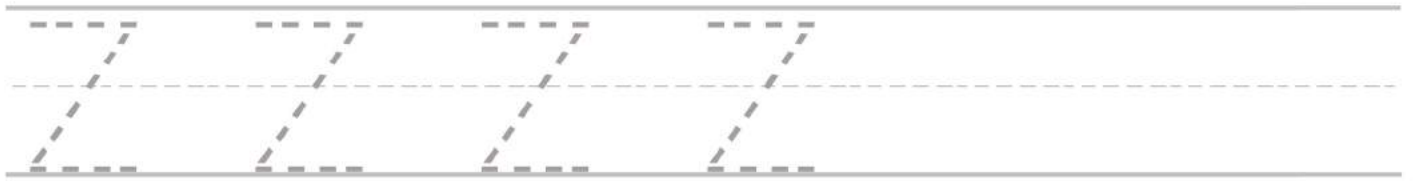
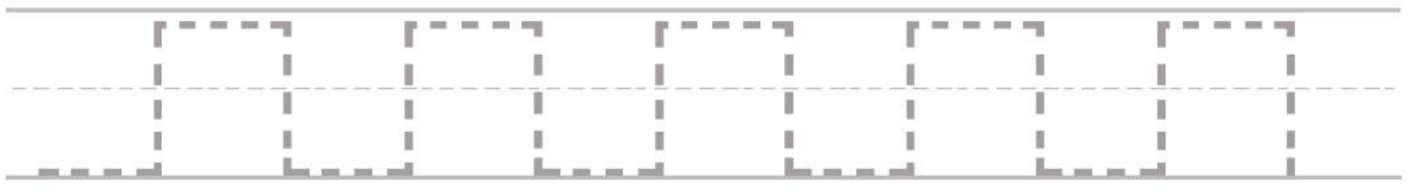

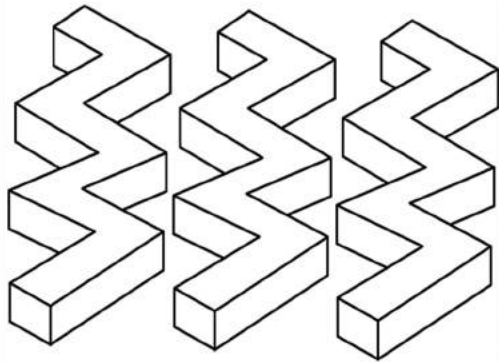

Trace the Zig Zags

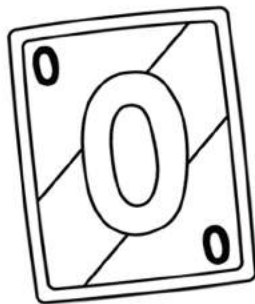

$15 - 15$

$3 - 3$

$14 - 12$

$12 - 12$

$2 - 2$

$11 - 11$

$6 - 5$

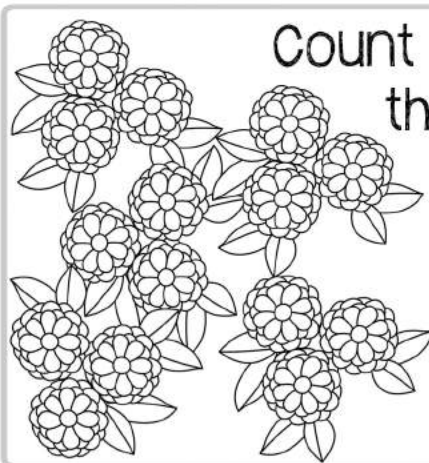
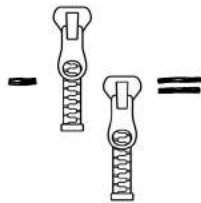
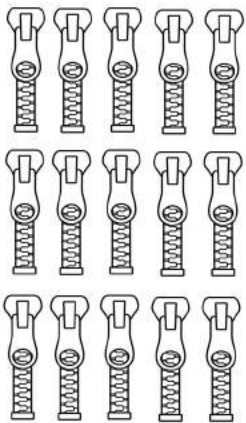

Count & Tally the zinnias

$15 - 1 = \square$

$15 - 2 = \square$

$$\begin{array}{r} 15 \\ - 3 \\ \hline \end{array}$$

$$\begin{array}{r} 15 \\ + 5 \\ \hline \end{array}$$

Draw a family to the right of the zoo. Draw a sun above them in the sky.

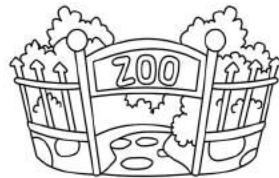

Zippy the zebra has 10 stripes.
Zane the zebra has 5 stripes.
How many stripes do they have all together?

Draw: $15 - 5 = 10$

- =

Zz

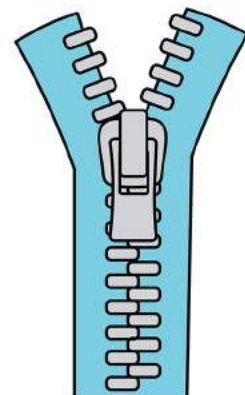
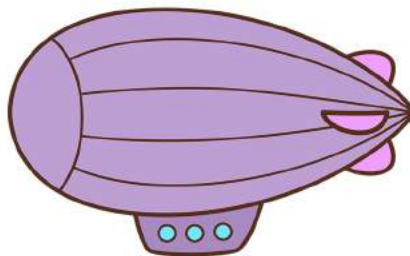
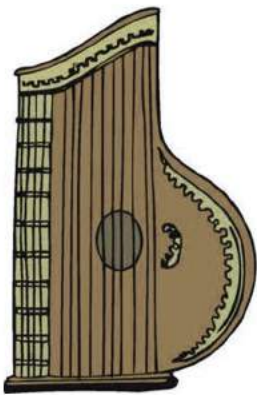
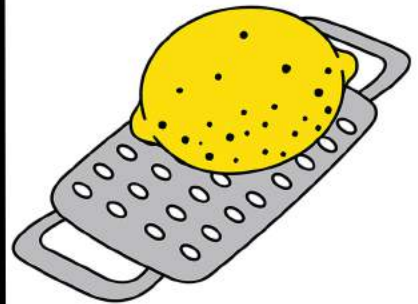
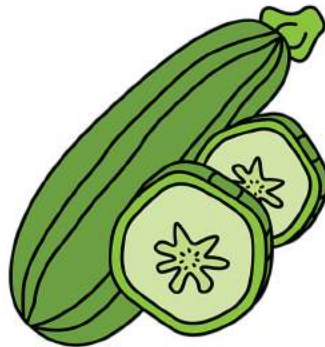
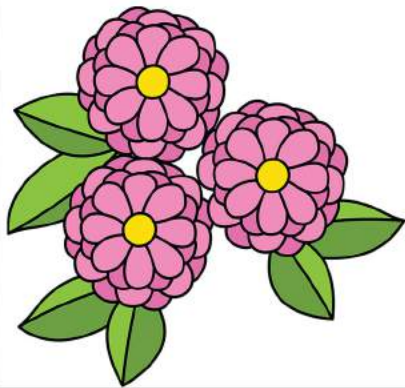
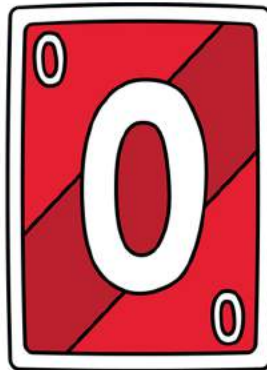
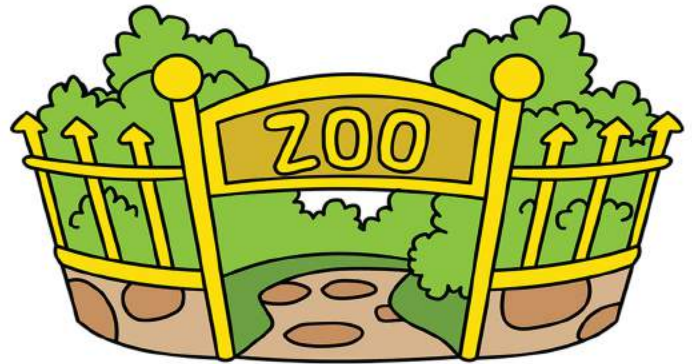

(zither)

I CAN COLOR

-  = zoo
-  = zucchini
-  = zeppelin
-  = zipper
-  = zebra

words with:

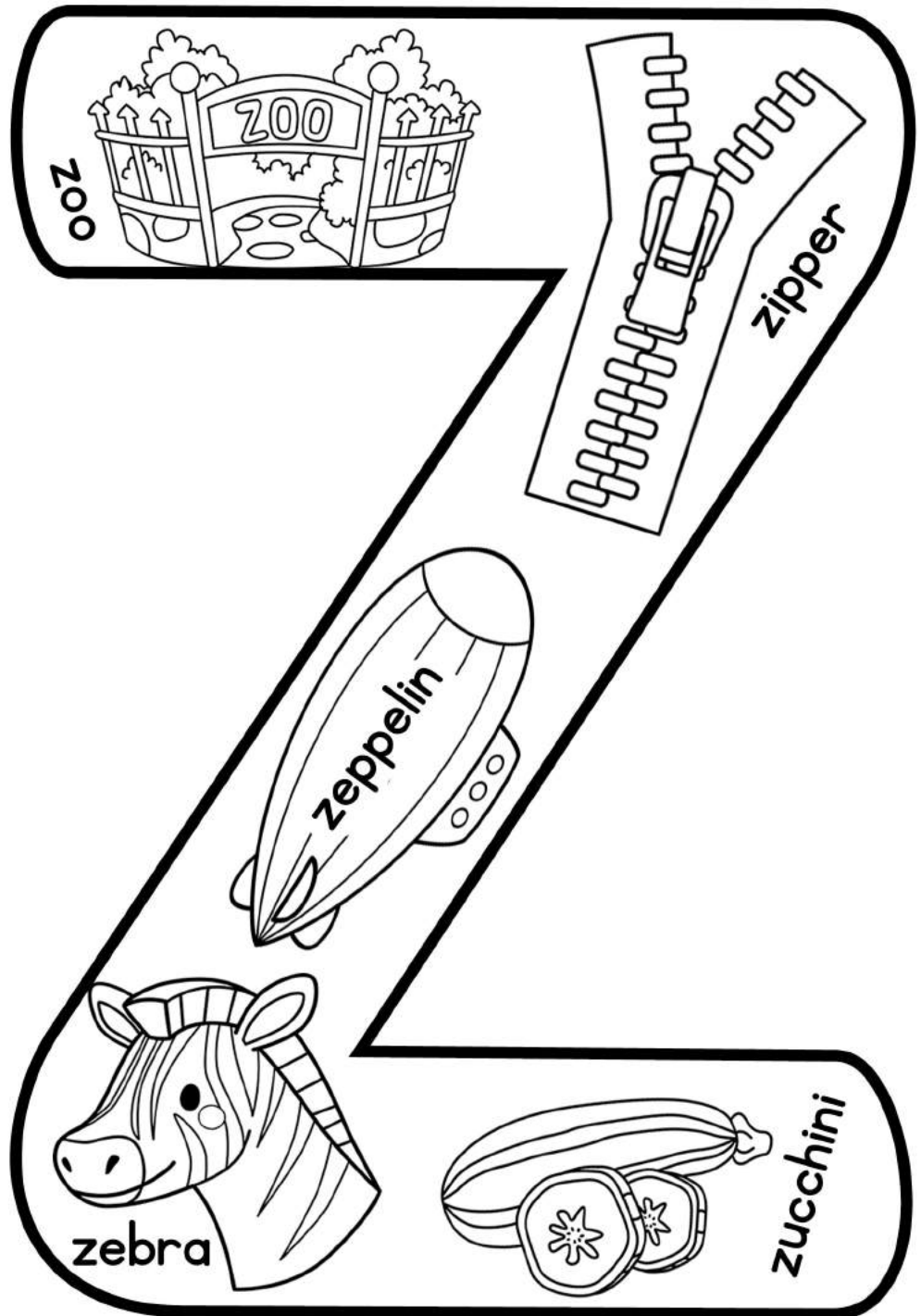

NAME : _____

Zz

Write and read words that begin with letter z.



zero zero



zoo zoo zoo

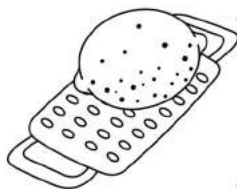

zest zest

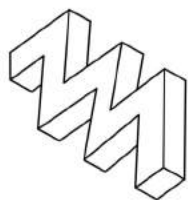

zig-zag

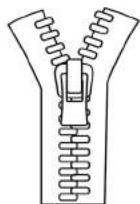

zipper zipper



zebra zebra



zucchini

NAME : _____

Zz

Write and read words that begin with letter z.



Zero Zero



Zoo Zoo Zoo

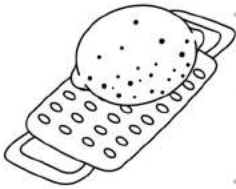

Zest Zest

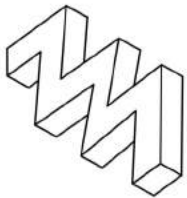

Zig-zag

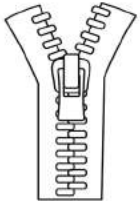

Zipper Zipper



Zebra Zebra



Zucchini

NAME : _____

R * A * C * E * T * O * T * H * E * T * O * P *

Use a paperclip and a pencil to complete the spinner.

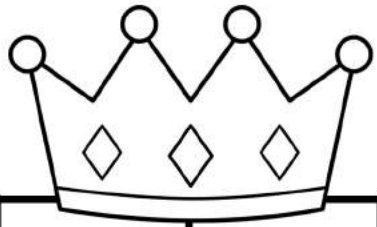

Z	z
Z	z
Z	z
Z	z
Z	z
Z	z
Z	z
Z	z
Z	z
Z	z

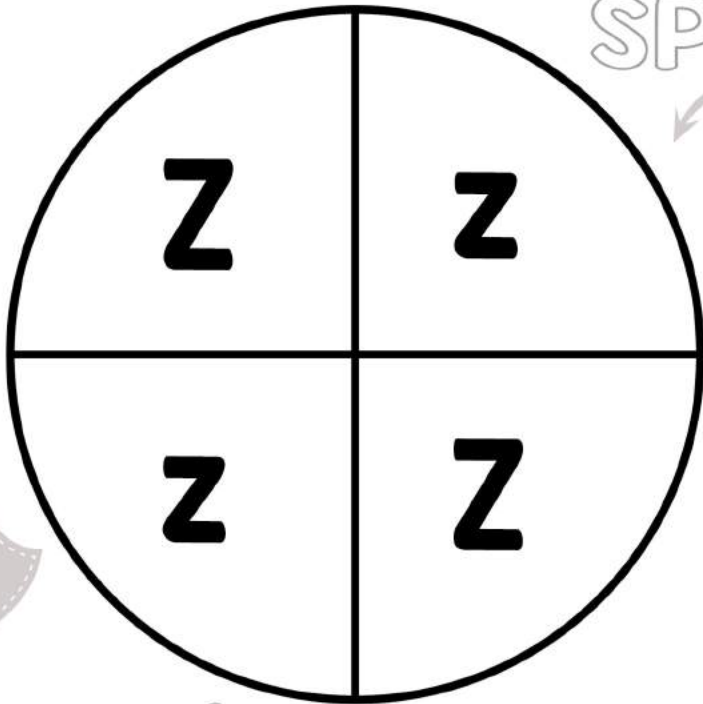

SPIN

Record

Report:

How many spins landed on Z?

How many spins landed on z?

Which had more?

Write an inequality: >

How many spins total?

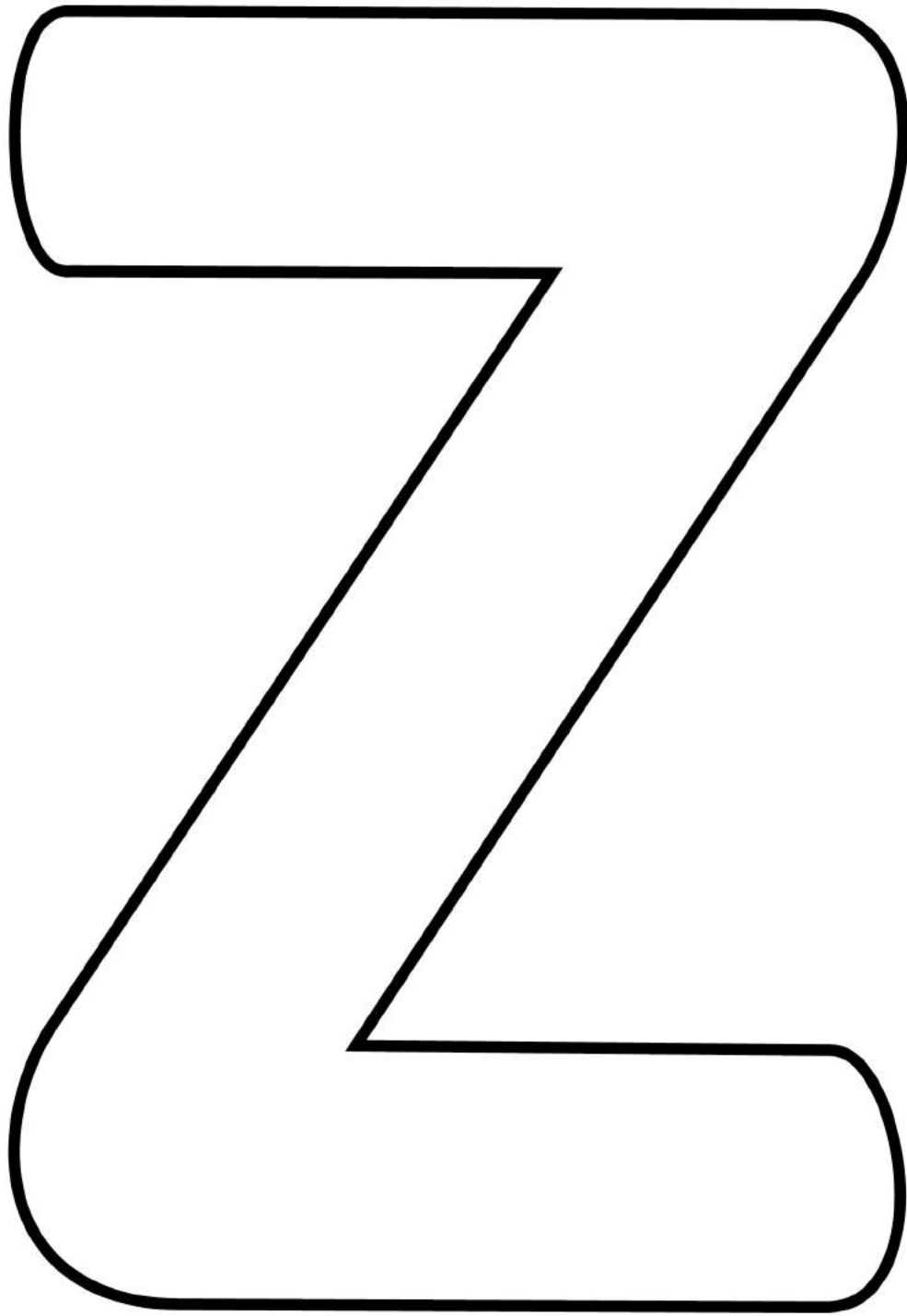

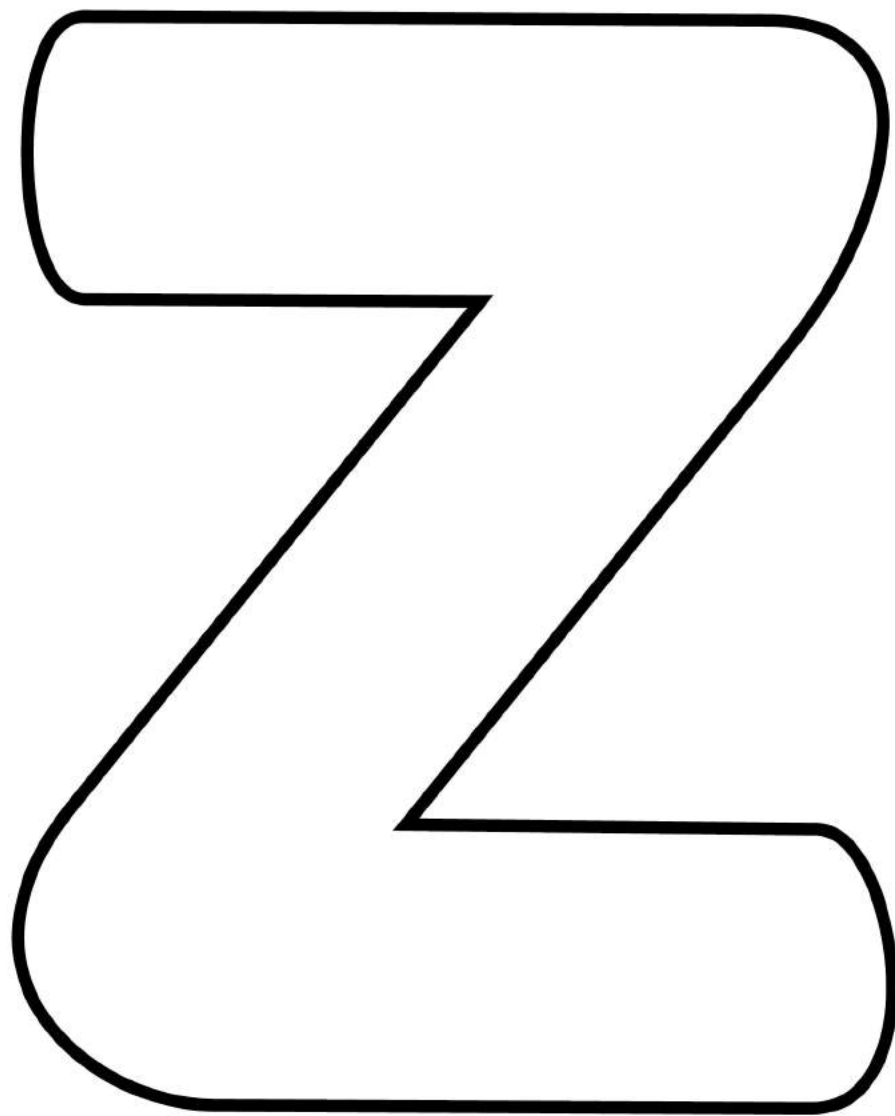



I C A N

F I N D

the letter:

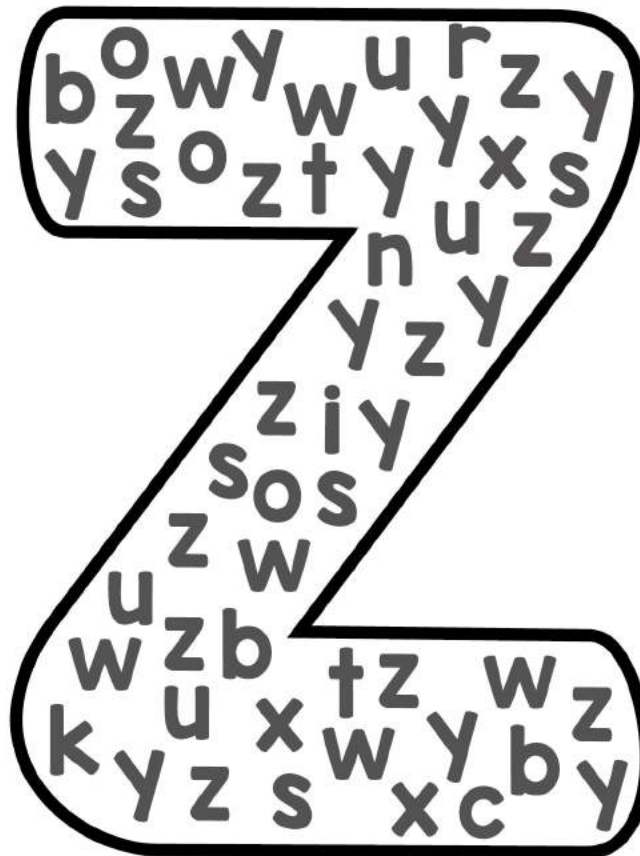
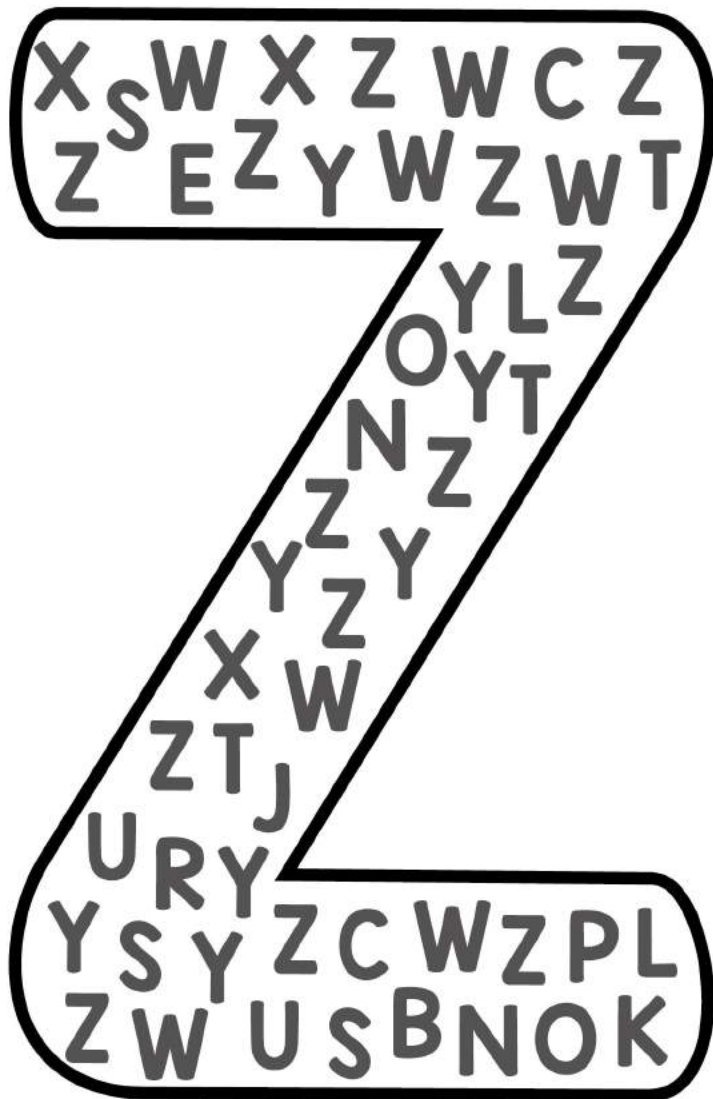

How Many?

How Many?

TRACE

NAME : _____

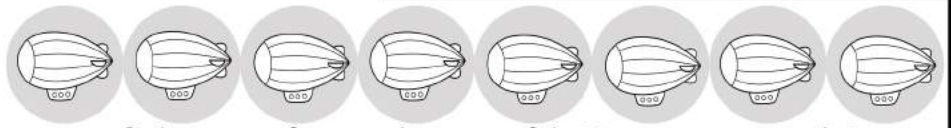



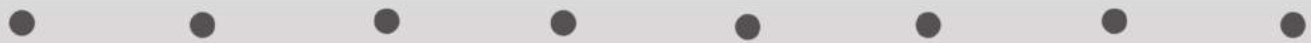

Color one for each row of letters you complete

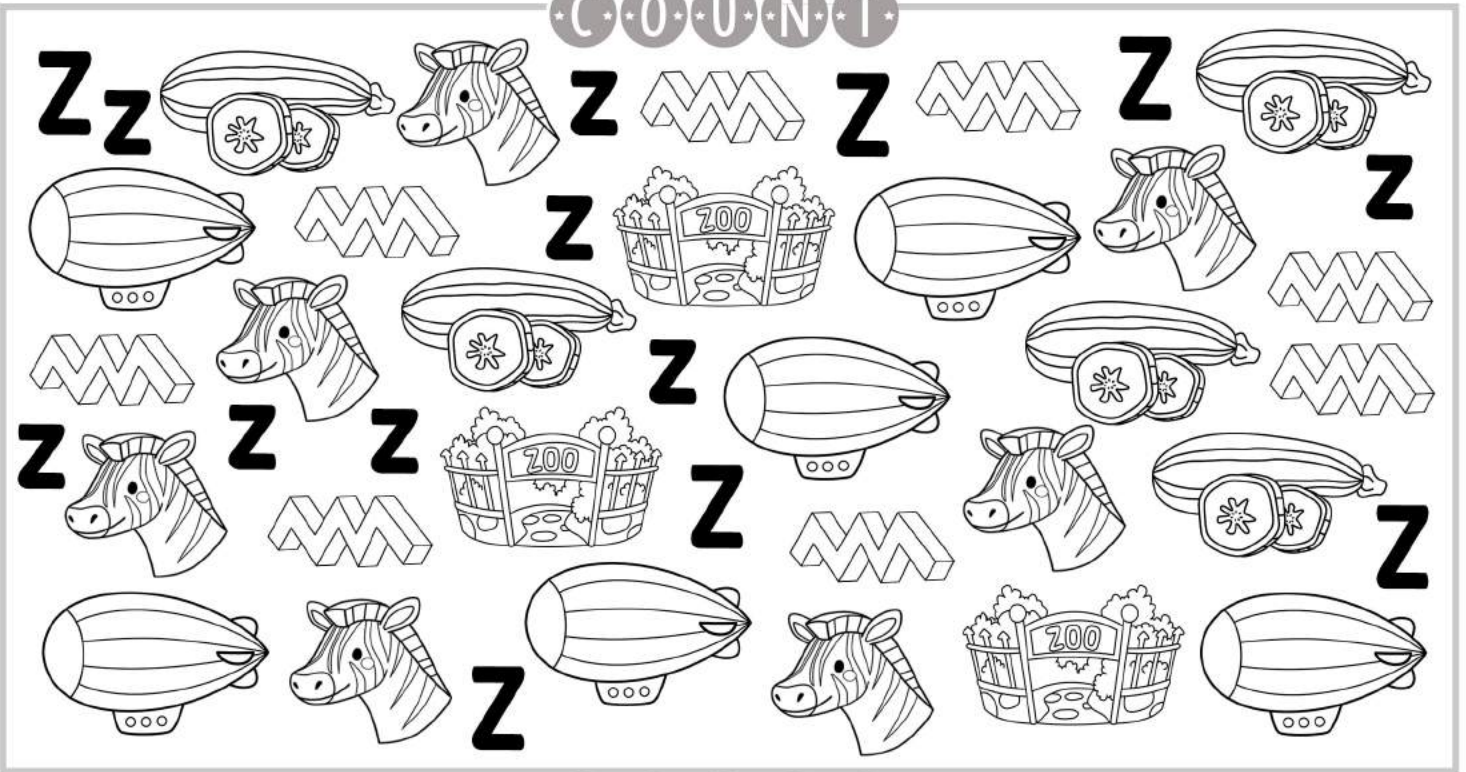

C·O·U·N·T

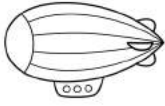

G·R·A·P·H

Z	z					

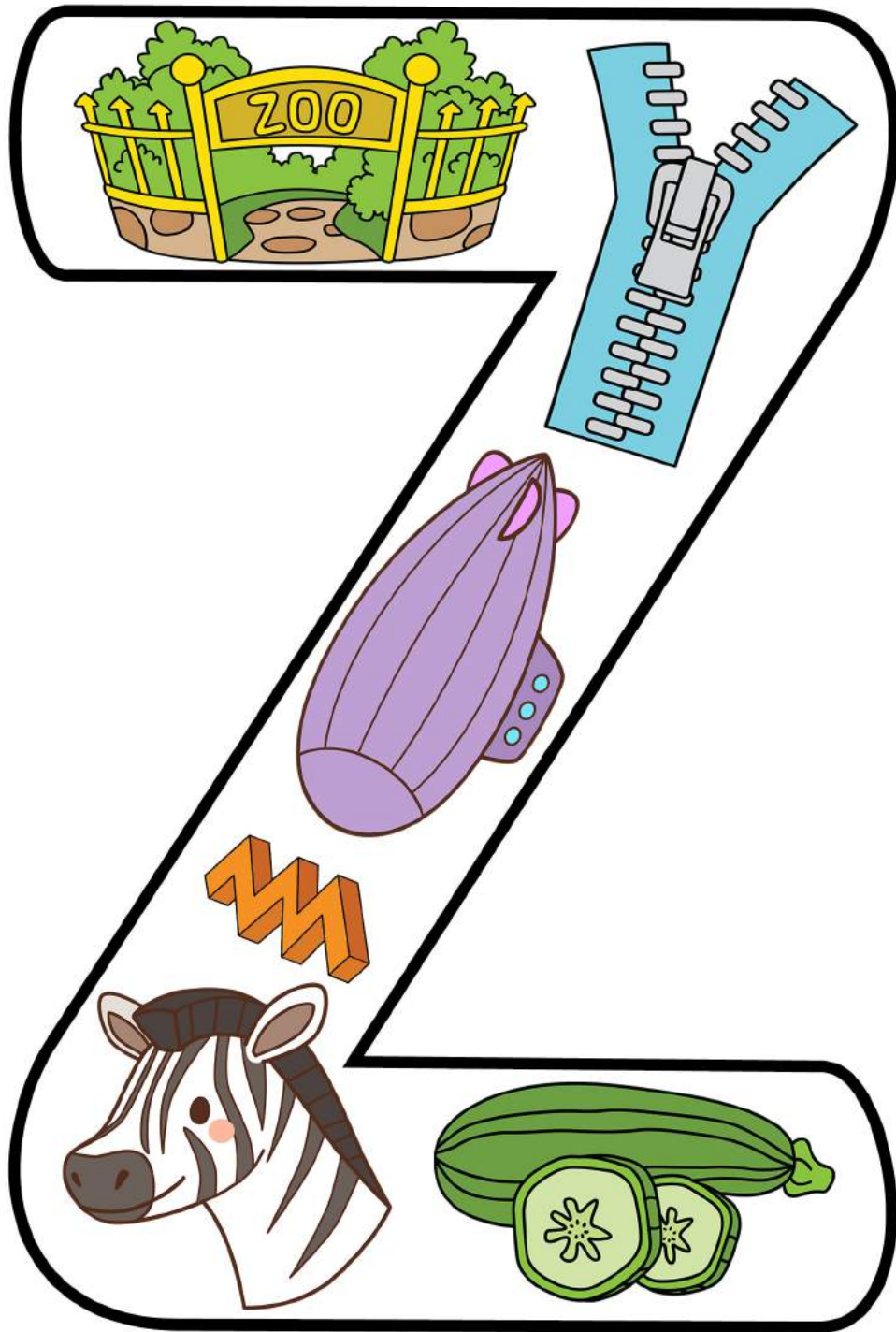

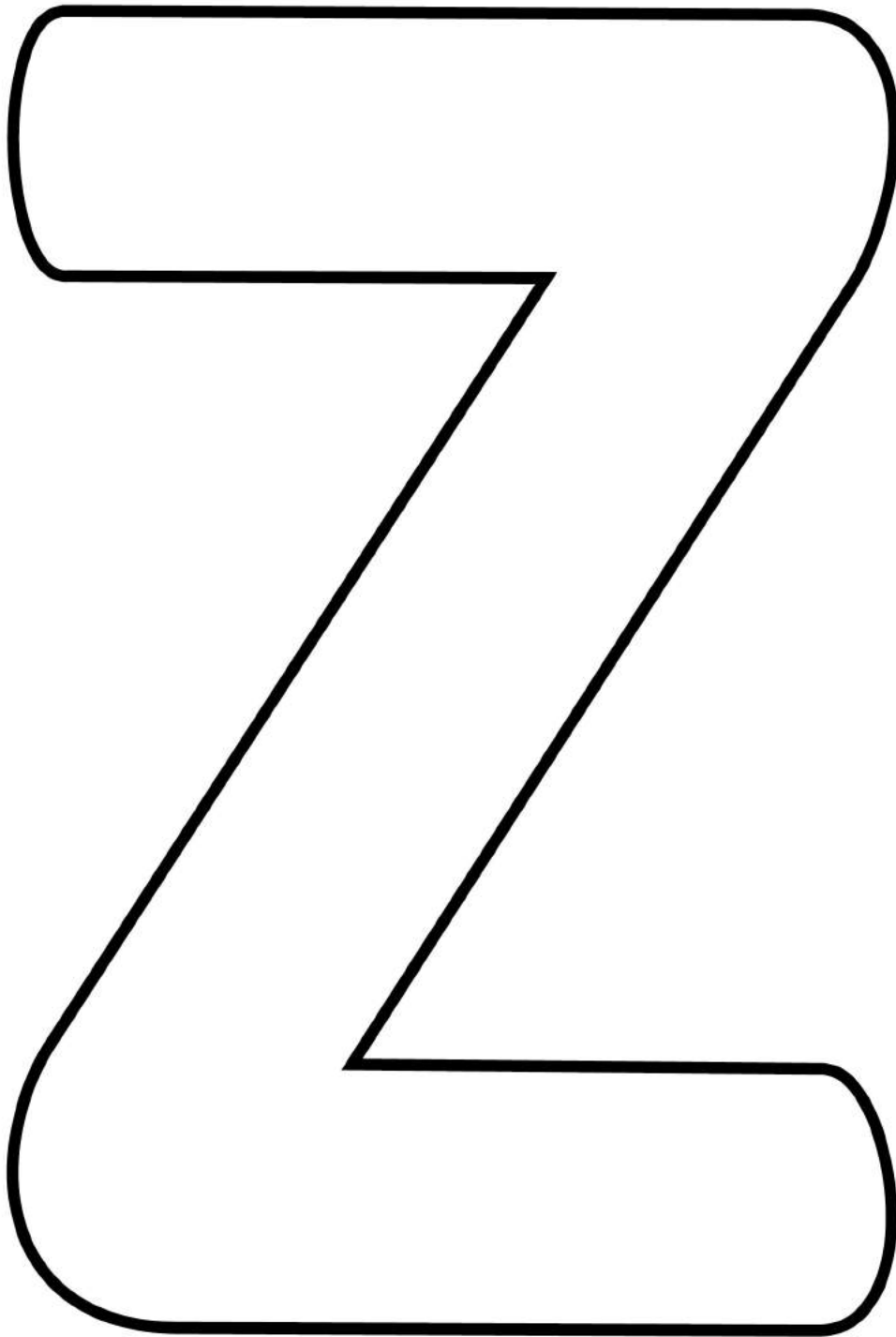

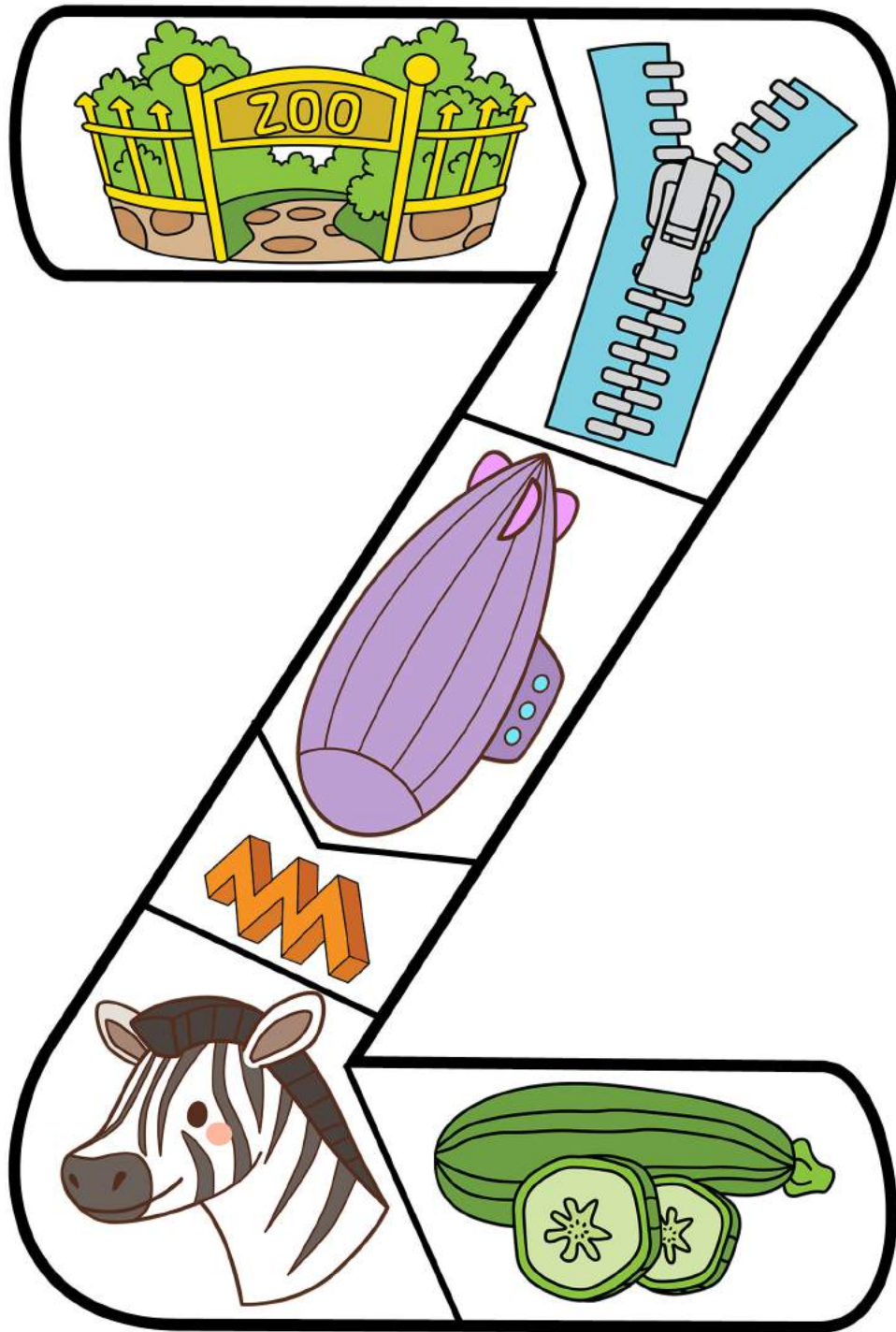

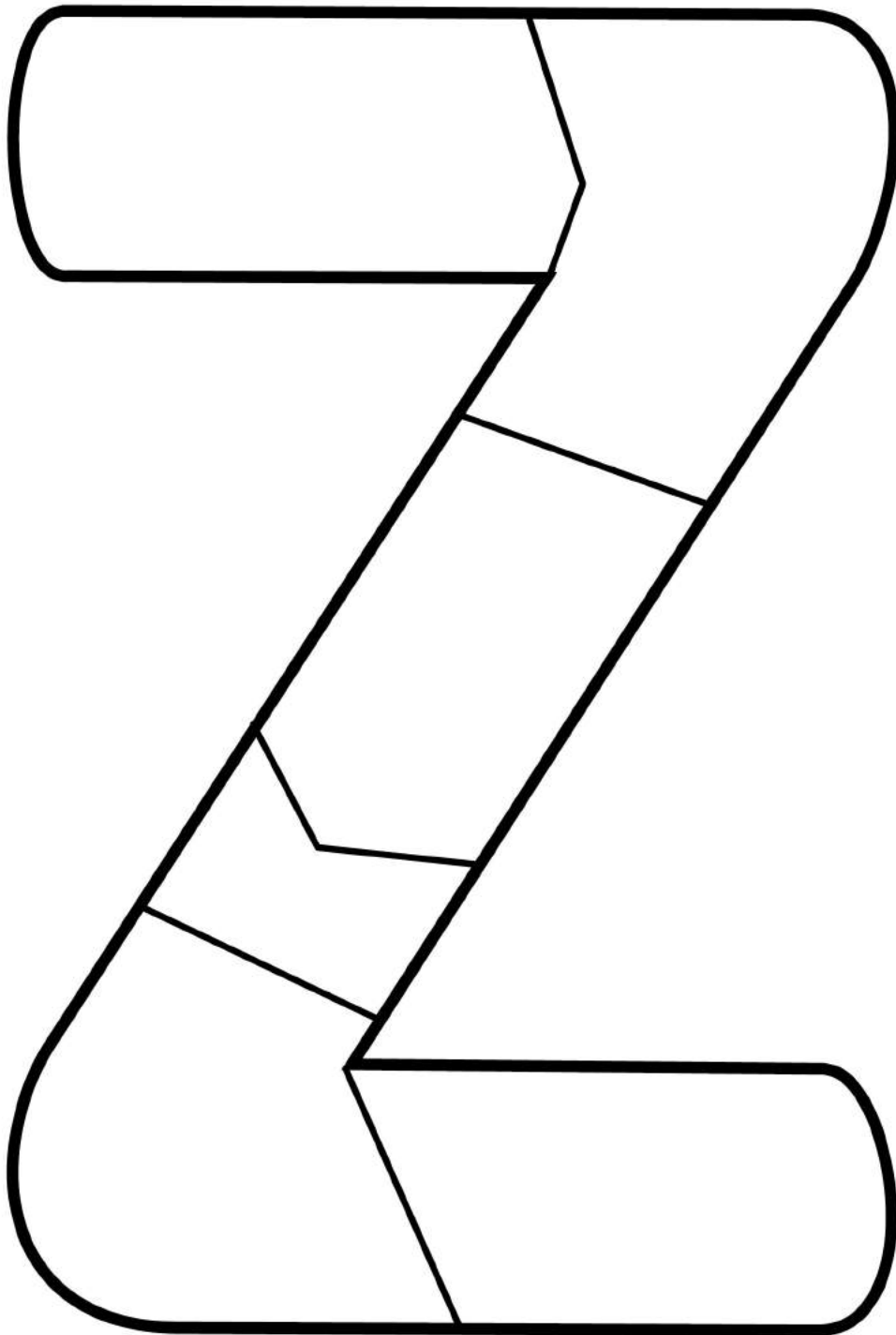

1. Write

2. Cut Out 

NAME : _____

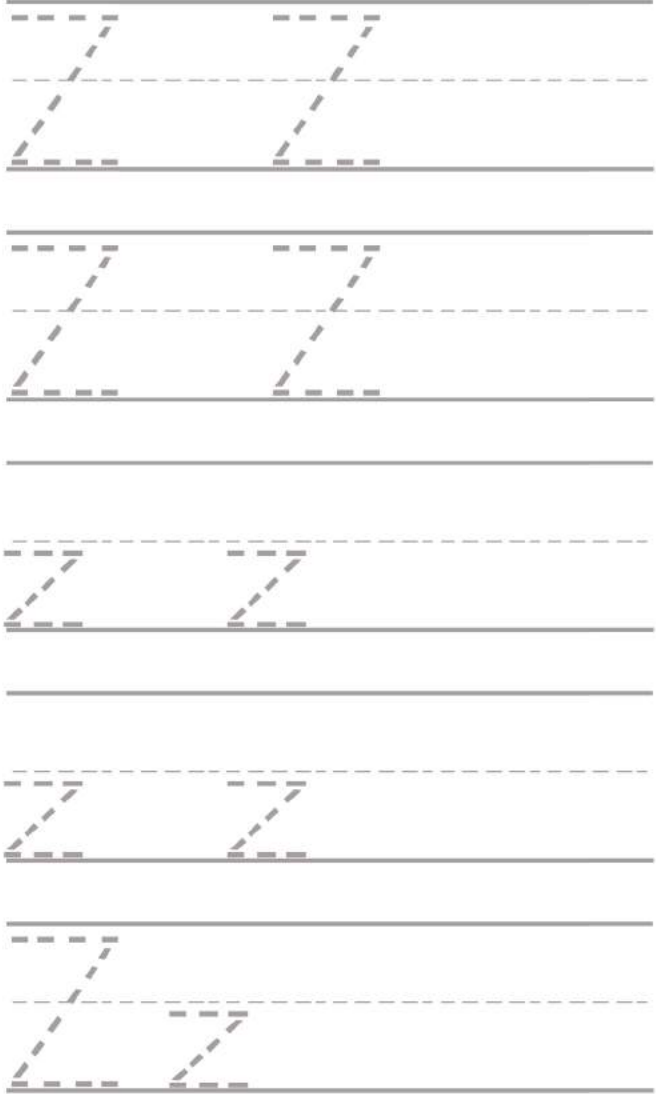

A B C Q U I L T

3. Color

4. Cut out 

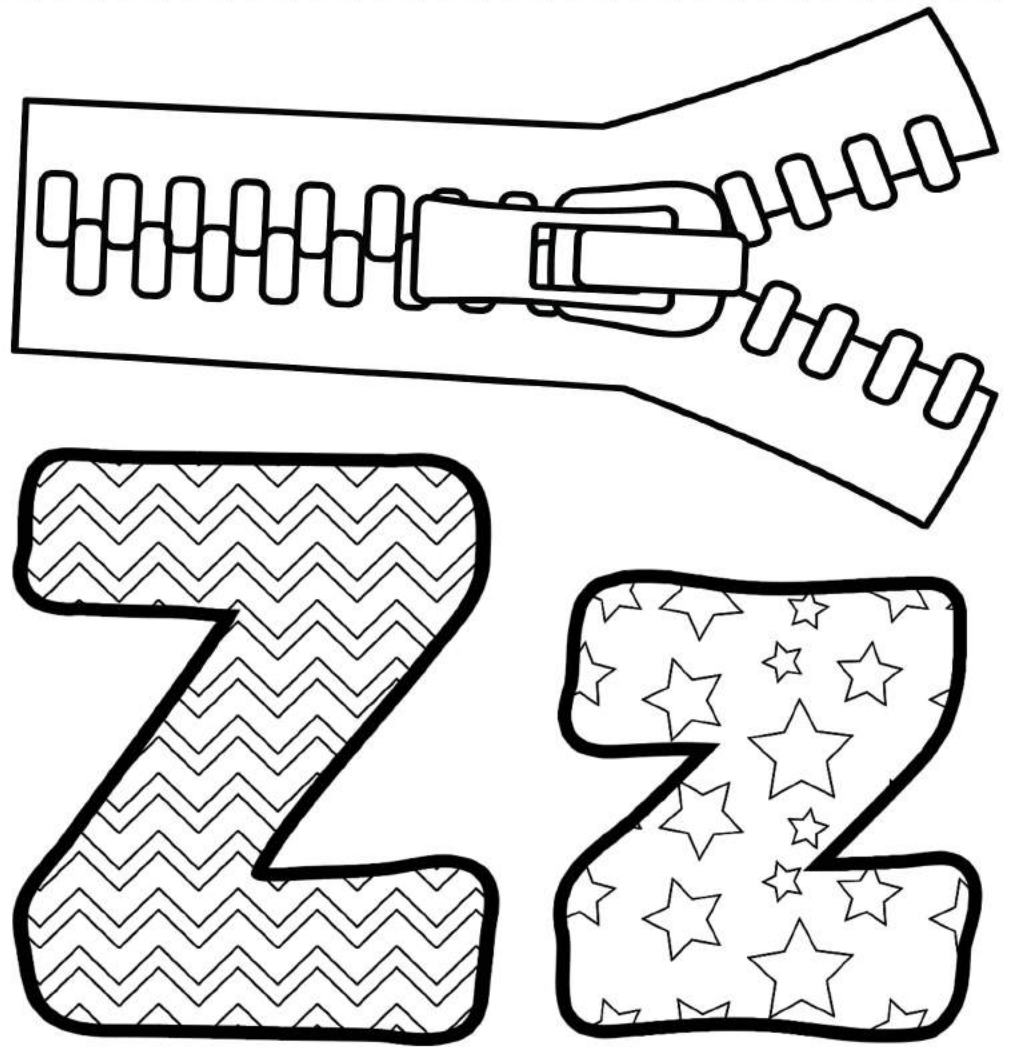

NAME : _____

NAME : _____

Zz

Write and read words that begin with letter z.



ero ero



oo oo oo

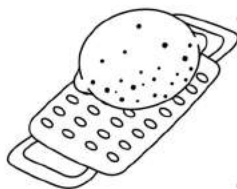

est est

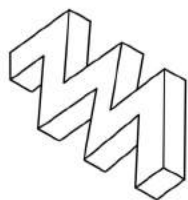

ig- ag

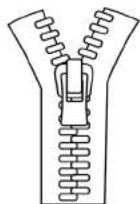

ipper ipper



eبرا eبرا



ucchini

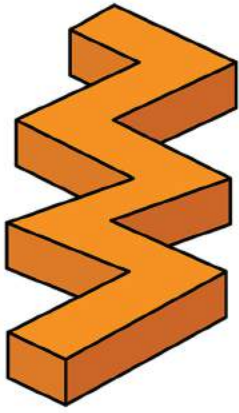

zig-zag

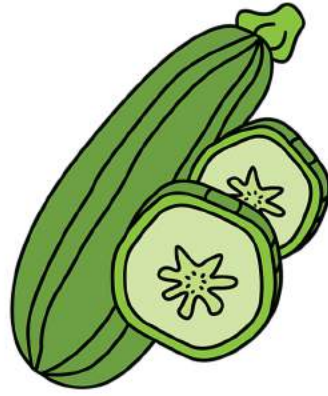

zucchini



zebra

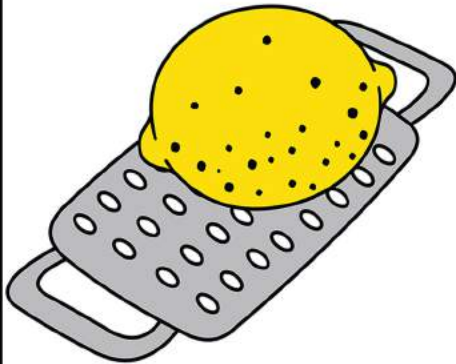

zest

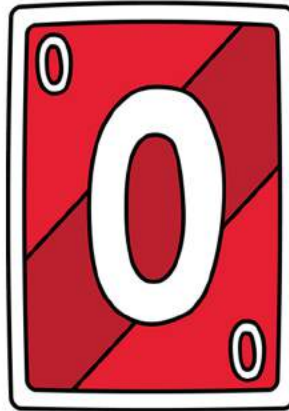

zero

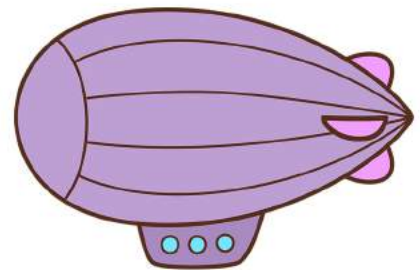

zeppelin

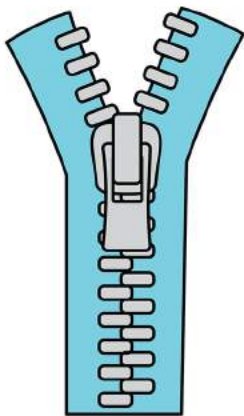

zipper

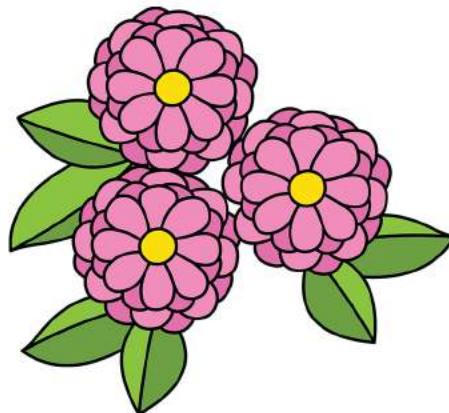

zinnia



zoo

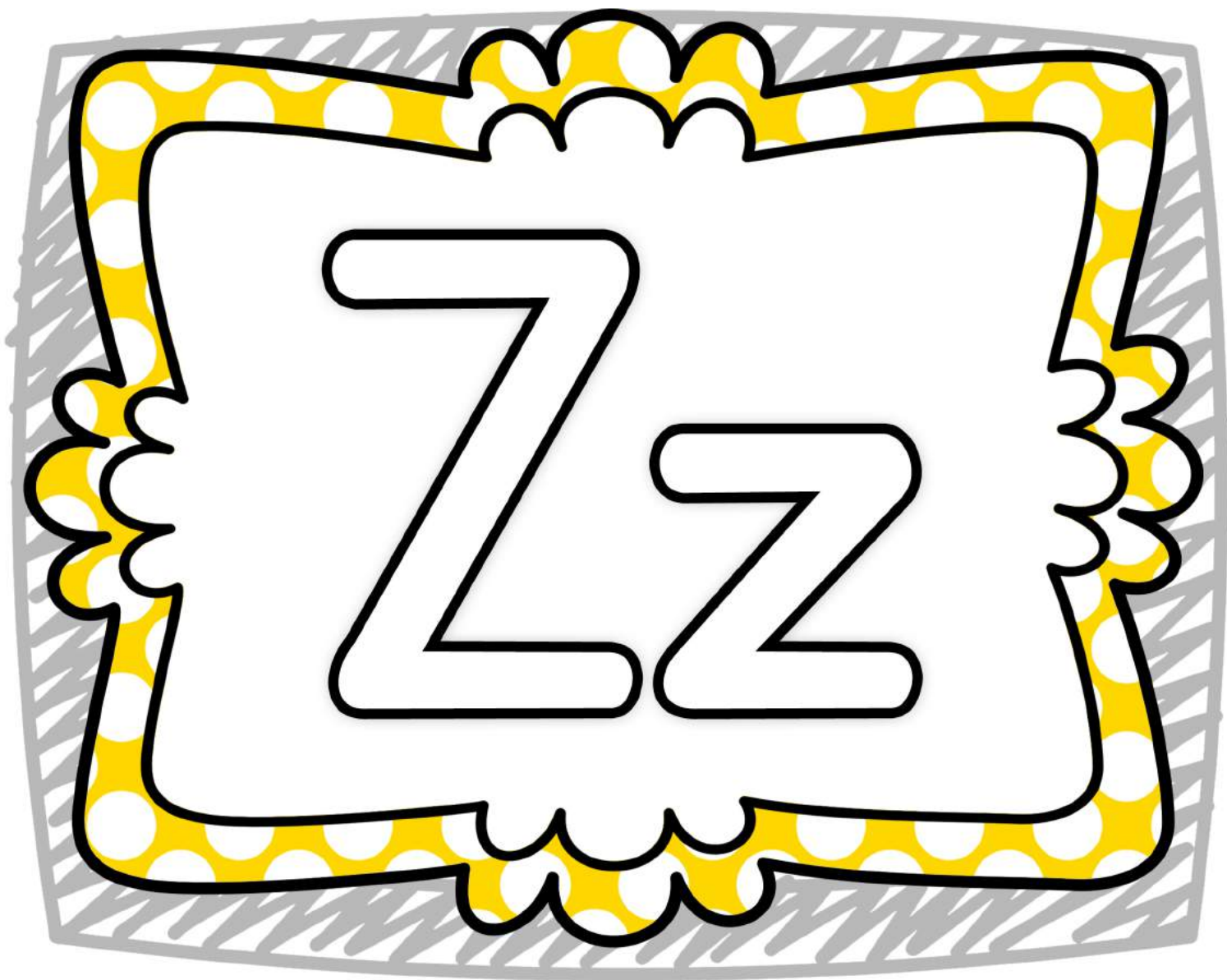

LETTER Z



4 IN A ROW

LETTER Z

















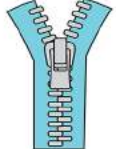

4 IN A ROW

LETTER Z



4 IN A ROW

LETTER Z



4 IN A ROW

